

修 订 REV NO	标 记 MARK	修 改 描 要 REVISION DESCRIPTION	签 名 SIGNATURE	日 期 DATE
		NEW DRG		2016-03-12

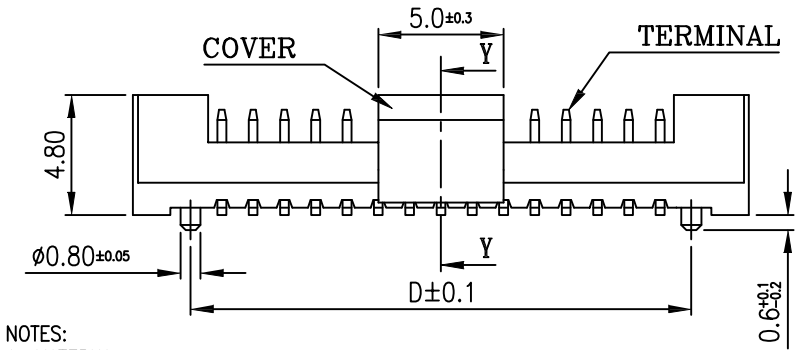

- NOTES:
- MATERIAL:
 - HOUSING: THERMOPLASTIC, HIGH TEMP.,UL94V-0; COLOR:NATURAL OR BLACK. 无卤PA6T
 - CONTACT: BRASS
 - FITTING NAIL: BRASS
 - VACUUM COVER:THERMOPLASTIC, HIGH TEMP.,UL94V-0; COLOR:NATURAL OR BLACK.
 - PLATING 100U" SN OVER 50U" NI
 - DIMENSION FOR W/H BOSS
 - REFLOW SOLDER CAPABLE TO 260°C
PFP SPFC

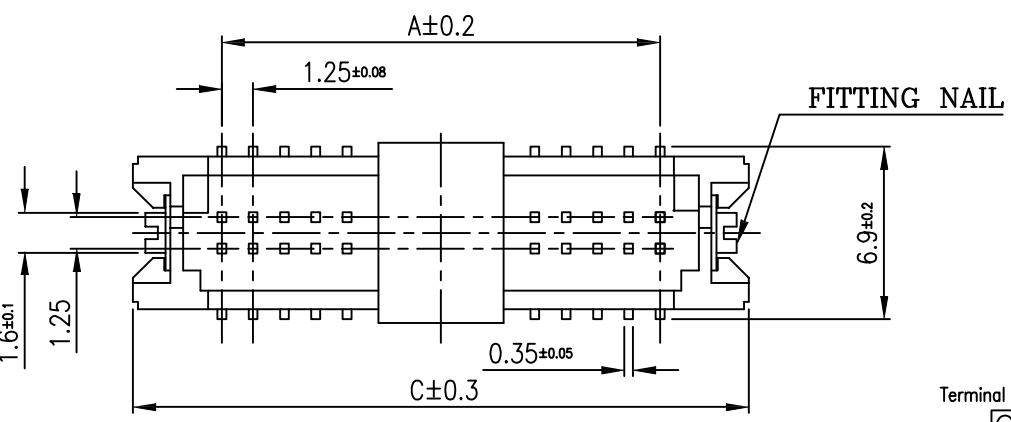
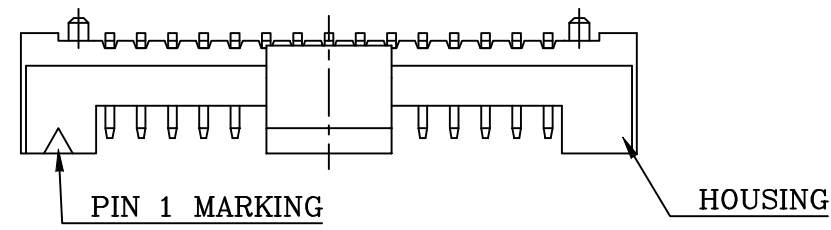
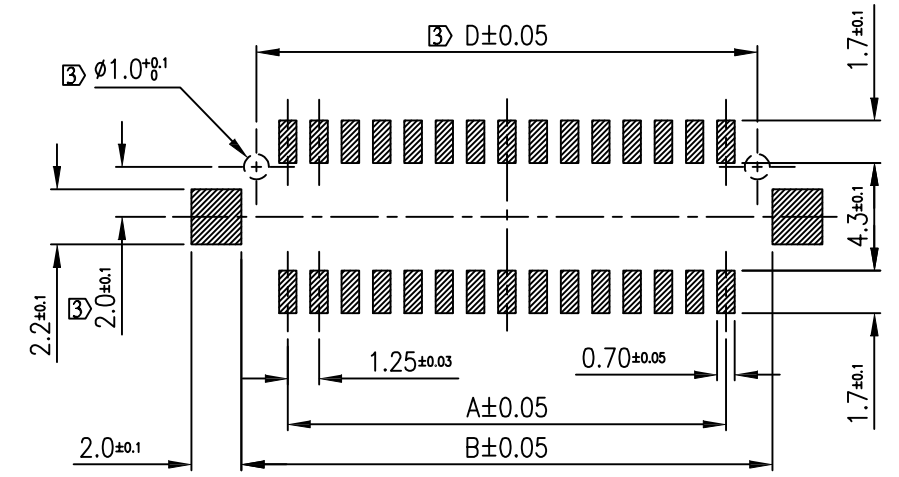

RECOMMENDED PATTERN

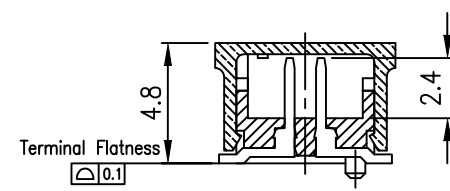

Y-Y SECTION

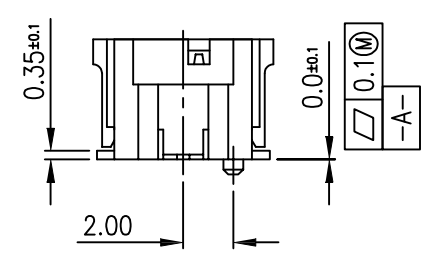



CKT	D1MA	D1MB	D1MC	D1MD
10	5.00	8.7	12.3	7.5
20	11.25	14.95	18.65	13.75
30	17.5	21.20	24.8	20.00
40	23.75	27.45	31.10	26.25
12	6.25	9.95	13.35	8.75
14	7.5	11.2	14.6	10.00
18	10.00	13.70	17.1	12.5



深圳市华德共创科技有限公司

Shenzhen Huade co-create Technology Co.,LTD

电话: 0755-27111225 传真: 0755-29940187

-TOLERANCES- UNLESS OTHERWISE SPECIFIED 公差参数表		 	TITLE: 产品名称: DF13 1.25间距双排立贴针座				
X.X	± 0.30	X.X*	$\pm 3^\circ$	APPD: 核准:		PART NO: 产品编号: HDGC1252WV-S-2XnP	
X.XX	± 0.20	X.XX*	$\pm 2^\circ$	CHECK: 校对: 王建业	DATE	SCALE	UNIT
X.XXX	± 0.10	X.XXX*	$\pm 1^\circ$	DRAW: 绘图: 黄艳兰	2016-03-12	1:1	mm
				CODE NUMBER	A001		

X-ON Electronics

Largest Supplier of Electrical and Electronic Components

Click to view similar products for [Headers & Wire Housings](#) category:

Click to view products by [HDGC](#) manufacturer:

Other Similar products are found below :

[57102-F02-18ULF](#) [58102-G61-06LF](#) [582553-1](#) [009176003701906](#) [01.001.5753.1](#) [0050291907](#) [02.125.8002.8](#) [609-3404](#) [61062-3](#)
[CSU011177004](#) [622-0430](#) [622-3653LF](#) [63453-116](#) [636-1030](#) [636-1427](#) [636-3427](#) [636-4007](#) [641938-9](#) [65495-038](#) [65692-001LF](#) [65781-018](#)
[65781-047](#) [65817-010LF](#) [65817-015LF](#) [66207-023LF](#) [67095-007LF](#) [67601157](#) [68631-112](#) [68645-018](#) [699319-000](#) [M90C108951C](#)
[70.362.1628.0](#) [70-4210](#) [70-4226B](#) [70-4853B](#) [707-5028](#) [71.350.2428.0](#) [71961-016LF](#) [733-134](#) [733-162](#) [754199-000](#) [760-3052](#) [80.063.4001.1](#)
[800-90-001-10-001000](#) [800-90-010-10-002000](#) [801-43-002-10-013000](#) [801-43-006-10-002000](#) [803-41-018-10-001000](#) [803-43-024-10-](#)
[001000](#) [803-93-012-10-001000](#)