

修 订	标 记	修 改 描 要	签 名	日 期
REV	MARK	REVISION DESCRIPTION	SIGNATURE	DATE
AO		NEW DRG		2016-03-12

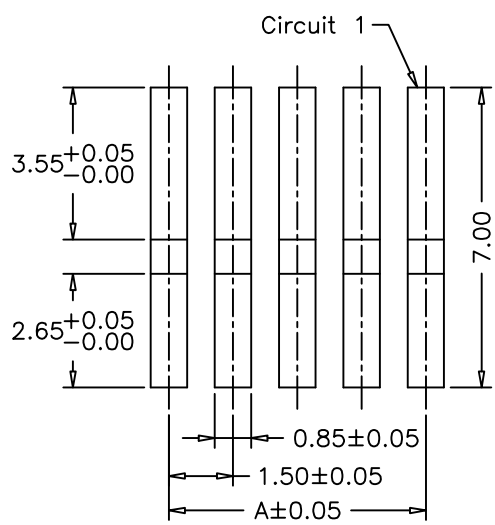

PCB LAYOUT

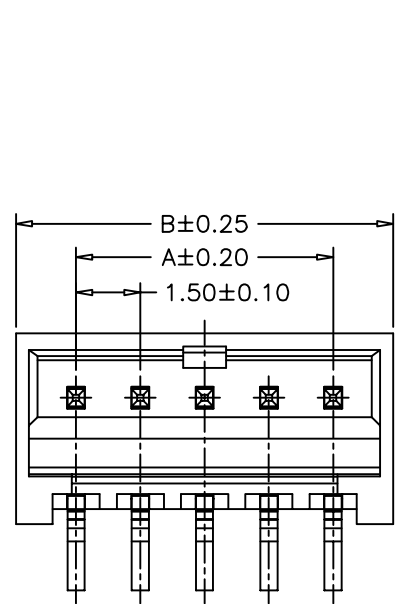
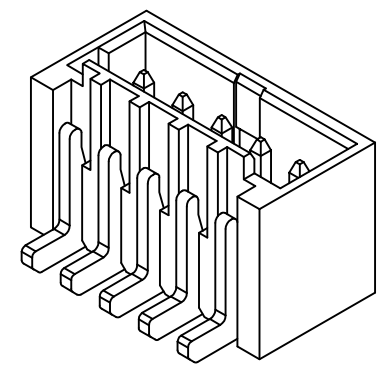

SPECIFICATIONS
 Current Rating: 3A AC,DC
 Voltage Rating: 350V AC,DC
 Temperature Range: -25°C ~ +85°C
 Contact Resistance: 20mΩ Max.
 Insulation Resistance: 1000MΩ Min.
 Withstanding Voltage: 500V AC/minute
 Pin Material: Brass/Tin-plated
 Material: Nylon 6T,UL94V-0
 Color: Natural(Beige)

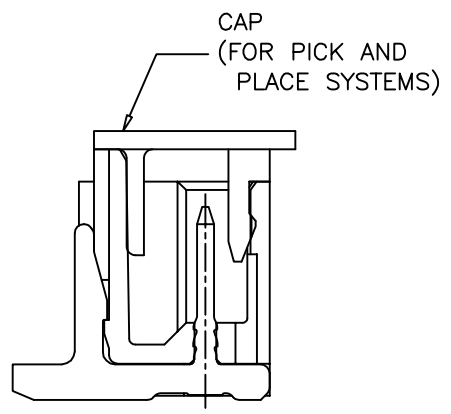
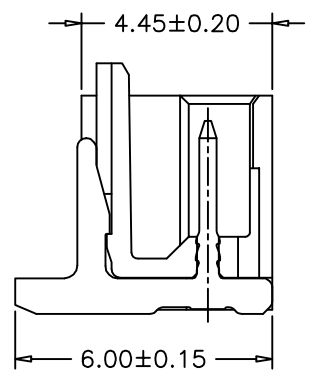
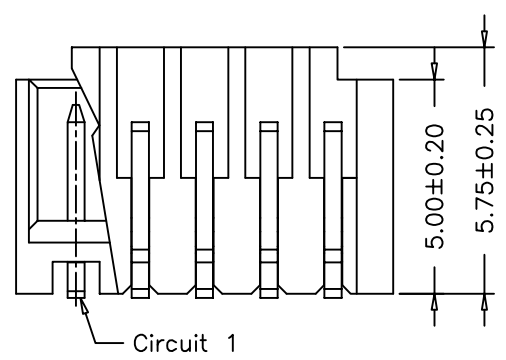

NO.	Dimensions	
	A	B
02P	1.50	4.30
03P	3.00	5.80
04P	4.50	7.30
05P	6.00	8.80
06P	7.50	10.30
07P	9.00	11.80
08P	10.50	13.30
09P	12.00	14.80
10P	13.50	16.30
11P	15.00	17.80
12P	16.50	19.30
13P	18.00	20.80
14P	19.50	22.30
15P	21.00	23.80

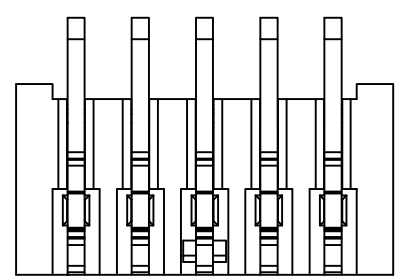



深圳市华德共创科技有限公司
 Shenzhen Huade co-create Technology Co.,LTD
 电话: 0755-27111225 传真: 0755-29940187

-TOLERANCES- UNLESS OTHERWISE SPECIFIED 公差参数表		TITLE: 产品名称: MX1.5立贴针座	
X.X ±0.30	X.X* ±3°	APPD: 核准:	PART NO: 产品编号: HDGC1502WV-S-XP
X.XX ±0.20	X.XX* ±2°	CHECK: 校对: 王建业	DATE
X.XXX ±0.10	X.XXX* ±1°	DRAW: 绘图: 黄艳兰	SCALE
			UNIT
			CODE NUMBER
		2016-03-12	1:1
			mm
			A001

X-ON Electronics

Largest Supplier of Electrical and Electronic Components

Click to view similar products for [Headers & Wire Housings](#) category:

Click to view products by [HDGC](#) manufacturer:

Other Similar products are found below :

[57102-F02-18ULF](#) [58102-G61-06LF](#) [582553-1](#) [009176003701906](#) [01.001.5753.1](#) [0050291907](#) [02.125.8002.8](#) [609-3404](#) [61062-3](#)
[CSU011177004](#) [622-0430](#) [622-3653LF](#) [63453-116](#) [636-1030](#) [636-1427](#) [636-3427](#) [636-4007](#) [641938-9](#) [644827-2](#) [65495-038](#) [65692-001LF](#)
[65781-018](#) [65781-047](#) [65817-010LF](#) [65817-015LF](#) [66207-023LF](#) [67095-007LF](#) [67601157](#) [68631-112](#) [68645-018](#) [699319-000](#)
[M90C108951C](#) [70.362.1628.0](#) [70-4210](#) [70-4226B](#) [70-4853B](#) [707-5028](#) [71.350.2428.0](#) [71961-016LF](#) [733-134](#) [733-162](#) [754199-000](#) [760-](#)
[3052](#) [80.063.4001.1](#) [800-90-001-10-001000](#) [800-90-010-10-002000](#) [801-43-002-10-013000](#) [801-43-006-10-002000](#) [803-41-018-10-001000](#)
[803-43-024-10-001000](#)