

修订 REV	标记 MARK	修改摘要 REVISION DESCRIPTION	签名 SIGNATURE	日期 DATE
A0		NEW DWG		2013-05-07

技术指标:

1. 温度范围: $-40^{\circ}\text{C} \sim 85^{\circ}\text{C}$.
2. 额定电压: 200V AC, DC.
3. 耐压: 200V AC/minute.
4. 接触电阻: $\leq 25\text{m}\Omega$.
5. 绝缘电阻: $\geq 1000\text{M}\Omega$.
6. 额定电流: 2A AC, DC.

CKT	A	B	C
2	2.00	4.50	5.70
3	4.00	6.50	7.70
4	6.00	8.50	9.70
5	8.00	10.50	11.70
6	10.00	12.50	13.70
7	12.00	14.50	15.70
8	14.00	16.50	17.70
9	16.00	18.50	19.70
10	18.00	20.50	21.70
11	20.00	22.50	23.70
12	22.00	24.50	25.70
13	24.00	26.50	27.70
14	26.00	28.50	29.70
15	28.00	30.50	31.70
16	30.00	32.50	33.70

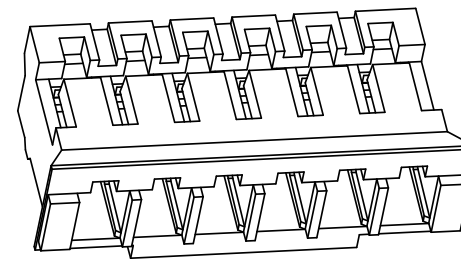
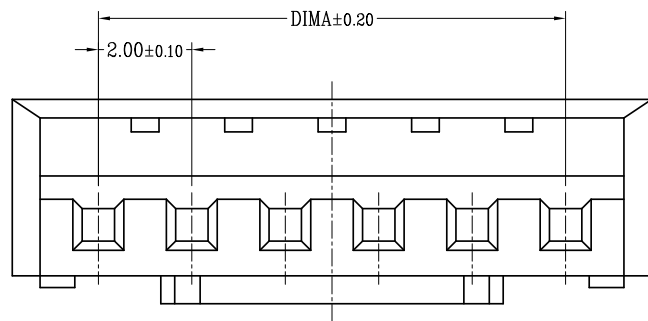
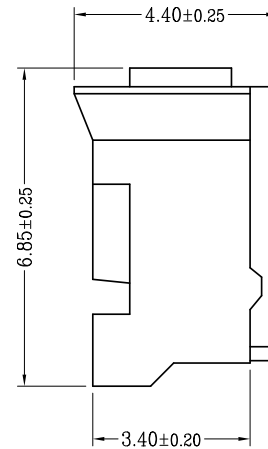
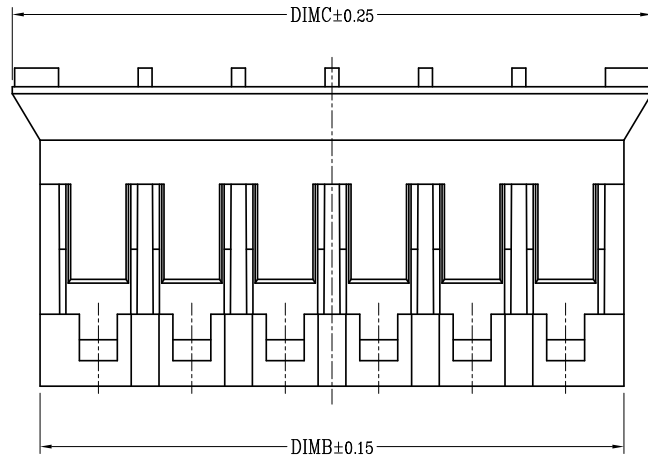

HDGC 深圳市华德共创科技有限公司
 Shenzhen Huade co-create Technology Co., LTD
 电话: 0755-27129737 传真: 0755-29940187

-TOLERANCES- UNLESS OTHERWISE SPECIFIED 公差参数表				TITLE: PH2.0胶壳 产品名称:			
X.X ± 0.30	X.X' ± 3°	APPD: 核准:	谢亮	PART NO: 产品编号: HDGC2001H-XP			
X.XX ± 0.30	X.XX' ± 2°	CHECK: 校对:	王建业	DATE	SCALE	UNIT	CODE NUMBER
X.XXX ± 0.10	X.XXX' ± 1°	DRAW: 绘图:	黄艳兰	2013-05-07	1:1	mm	A003

环保物料

修订 REV	标记 MARK	修改摘要 REVISION DESCRIPTION	签名 SIGNATURE	日期 DATE
A0		NEW DWG		2015-10-09
A1	※	端子倒扣尺寸改低, 以便端子插入塑胶更顺畅		2022-03-11

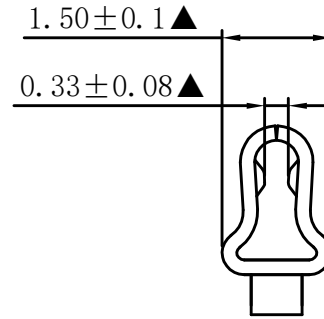
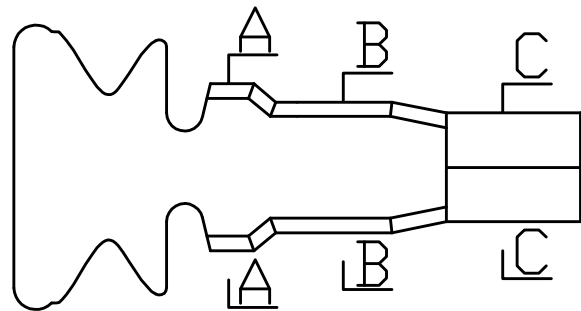
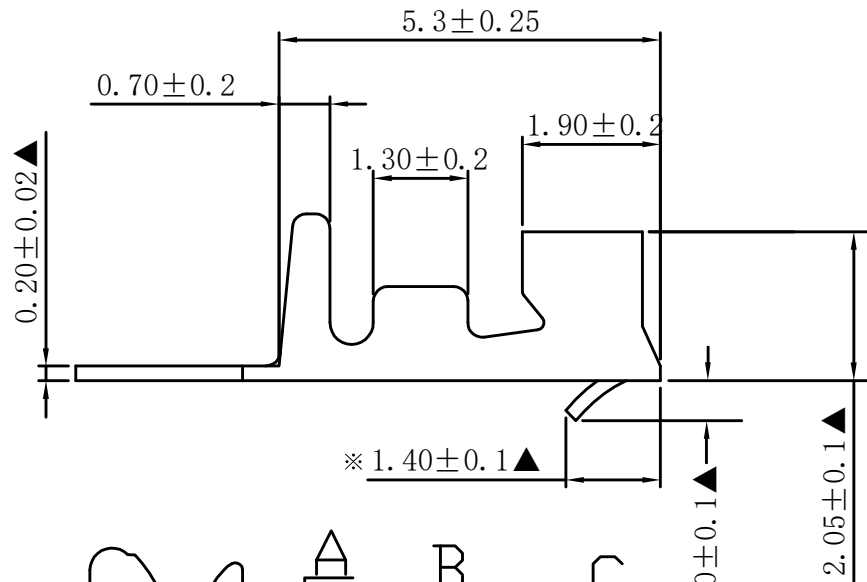

C-C旋转

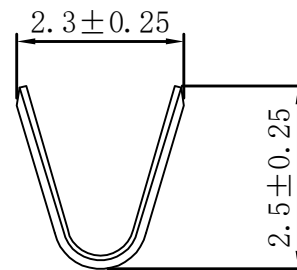

A-A旋转

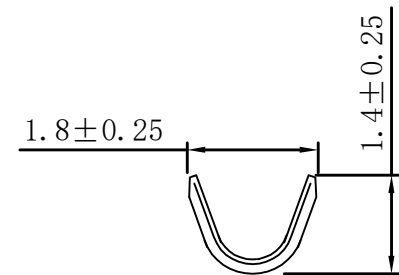

B-B旋转

注明:

- 零件外观要求无毛刺和机械损伤;
- 镀锡镍底, 镀层均匀, 无雾斑;
- ▲为重点尺寸。

		深圳市华德共创科技有限公司 Shenzhen Huade co-create Technology Co., LTD 电话: 0755-27129737 传真: 0755-29940187						
		-TOLERANCES- UNLESS OTHERWISE SPECIFIED 公差参数表				TITLE: 产品名称: PH2.0-TER		
X.	±0.20	X.X*	±3°	APPD: 核准: 谢亮	PART NO: 产品编号: HDGC2001-T			
X.X	±0.15	X.XX*	±2°	CHECK: 校对: 王建设	DATE	SCALE	UNIT	CODE NUMBER
X.XX	±0.08	X.XXX*	±1°	DRAW: 绘图: 黄艳兰	2022-03-11	1:1	mm	A001
X.XXX	±0.05							

X-ON Electronics

Largest Supplier of Electrical and Electronic Components

Click to view similar products for [Headers & Wire Housings](#) category:

Click to view products by [HDGC](#) manufacturer:

Other Similar products are found below :

[57102-F02-18ULF](#) [58102-G61-06LF](#) [582553-1](#) [009176003701906](#) [01.001.5753.1](#) [0050291907](#) [02.125.8002.8](#) [609-3404](#) [61062-3](#)
[CSU011177004](#) [622-0430](#) [622-3653LF](#) [63453-116](#) [636-1030](#) [636-1427](#) [636-3427](#) [636-4007](#) [641938-9](#) [65495-038](#) [65692-001LF](#) [65781-018](#)
[65781-047](#) [65817-010LF](#) [65817-015LF](#) [66207-023LF](#) [67095-007LF](#) [67601157](#) [68631-112](#) [68645-018](#) [699319-000](#) [M90C108951C](#)
[70.362.1628.0](#) [70-4210](#) [70-4226B](#) [70-4853B](#) [707-5028](#) [71.350.2428.0](#) [71961-016LF](#) [733-134](#) [733-162](#) [754199-000](#) [760-3052](#) [80.063.4001.1](#)
[800-90-001-10-001000](#) [800-90-010-10-002000](#) [801-43-002-10-013000](#) [801-43-006-10-002000](#) [803-41-018-10-001000](#) [803-43-024-10-](#)
[001000](#) [803-93-012-10-001000](#)