

环保物料

修订 REV	标记 MARK	修改摘要 REVISION DESCRIPTION	签名 SIGNATURE	日期 DATE
A0		NEW DWG		2015-10-09
A1	※	端子倒扣尺寸改低, 以便端子插入塑胶更顺畅		2022-03-11

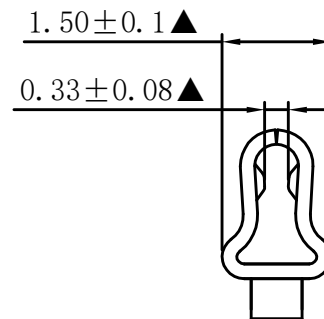

C-C旋转

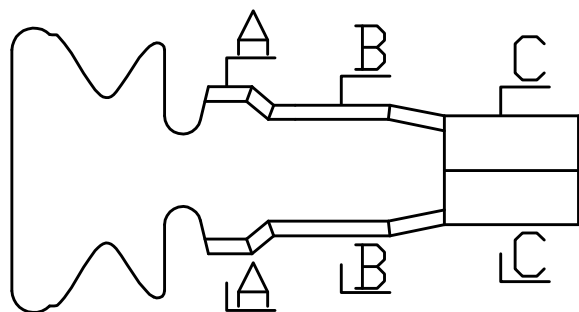
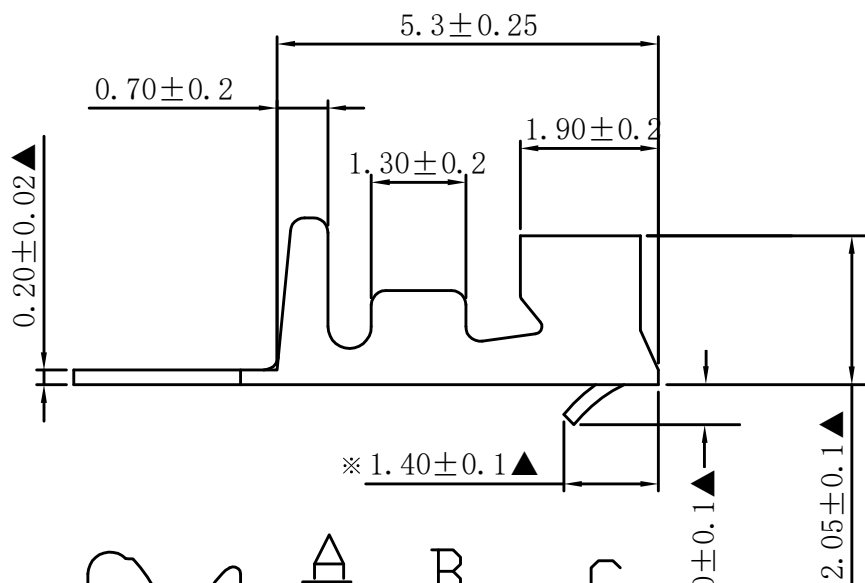
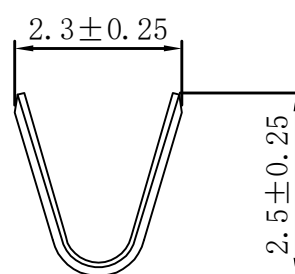

A-A旋转

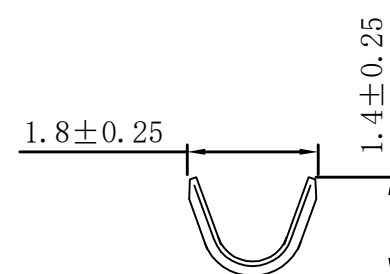

B-B旋转

注明:

- 零件外观要求无毛刺和机械损伤;
- 镀锡镍底, 镀层均匀, 无雾斑;
- ▲为重点尺寸。

 深圳市华德共创科技有限公司 Shenzhen Huade co-create Technology Co., LTD 电话: 0755-27129737 传真: 0755-29940187		TITLE: PH2.0-TER 产品名称:				
		PART NO: HDGC2001-T 产品编号:				
X. ±0.20 X.X ±0.15 X.XX ±0.08 X.XXX ±0.05	X.X* ±3° X.XX* ±2° X.XXX* ±1°	APPD: 谢亮 核准: CHECK: 王建业 校对: DRAW: 黄艳兰 绘图:	DATE	SCALE	UNIT	CODE NUMBER
			2022-03-11	1:1	mm	A001

修订 REV	标记 MARK	修改摘要 REVISION DESCRIPTION	签名 SIGNATURE	日期 DATE
A0		NEW DWG		2013-05-07

技术指标:

1. 温度范围: $-40^{\circ}\text{C} \sim 85^{\circ}\text{C}$.
2. 额定电压: 200V AC, DC.
3. 耐压: 200V AC/minute.
4. 接触电阻: $\leq 25\text{m}\Omega$.
5. 绝缘电阻: $\geq 1000\text{M}\Omega$.
6. 额定电流: 2A AC, DC.

CKT	A	B	C
2	2.00	4.50	5.70
3	4.00	6.50	7.70
4	6.00	8.50	9.70
5	8.00	10.50	11.70
6	10.00	12.50	13.70
7	12.00	14.50	15.70
8	14.00	16.50	17.70
9	16.00	18.50	19.70
10	18.00	20.50	21.70
11	20.00	22.50	23.70
12	22.00	24.50	25.70
13	24.00	26.50	27.70
14	26.00	28.50	29.70
15	28.00	30.50	31.70
16	30.00	32.50	33.70

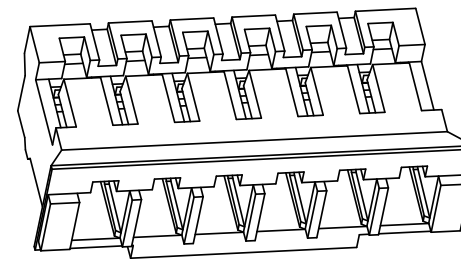
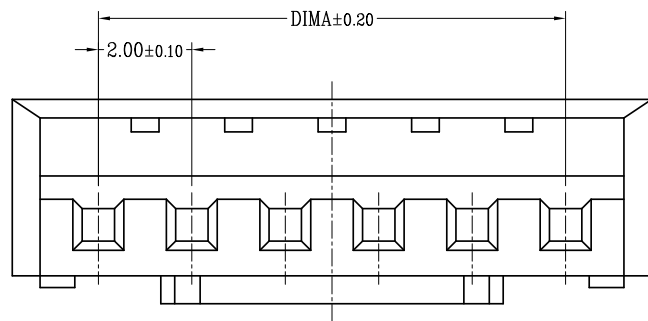
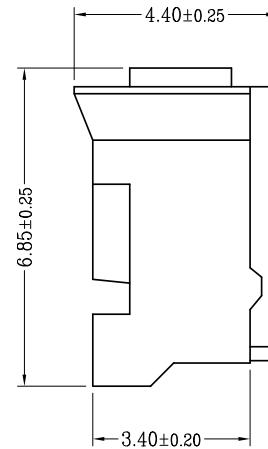
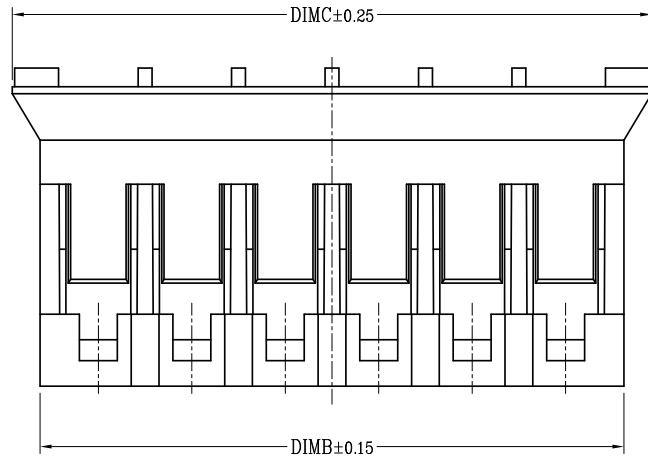

 深圳市华德共创科技有限公司 Shenzhen Huade co-create Technology Co., LTD 电话: 0755-27129737 传真: 0755-29940187		TITLE: PH2.0胶壳 产品名称:	
		PART NO: HDGC2001H-XP 产品编号:	
X.X ± 0.30 X.XX ± 0.30 X.XXX ± 0.10	X.X' ± 3° X.XX' ± 2° X.XXX' ± 1°	APPD: 谢亮 核准:	CHECK: 王建业 校对:
		DRAW: 黄艳兰 绘图:	DATE: 2013-05-07 SCALE: 1:1 UNIT: mm CODE NUMBER: A003

-TOLERANCES- UNLESS OTHERWISE SPECIFIED 公差参数表	
X.X ± 0.30	X.X' ± 3°
X.XX ± 0.30	X.XX' ± 2°
X.XXX ± 0.10	X.XXX' ± 1°

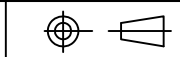

TITLE: PH2.0胶壳 产品名称:			
PART NO: HDGC2001H-XP 产品编号:			
DATE	SCALE	UNIT	CODE NUMBER
2013-05-07	1:1	mm	A003

X-ON Electronics

Largest Supplier of Electrical and Electronic Components

Click to view similar products for [Terminals](#) category:

Click to view products by [HDGC](#) manufacturer:

Other Similar products are found below :

[00-054007-01074-6](#) [00-054007-70206-1](#) [00-054007-70210-8](#) [00-054007-70217-7](#) [00-054007-70228-3](#) [00-054007-70256-6](#) [00-054007-70316-7](#) [00-054007-49560-4](#) [00-054007-70209-2](#) [00-054007-70231-3](#) [00-054007-70241-2](#) [00-054007-70242-9](#) [00-054007-70246-7](#) [00-054007-70263-4](#) [00-054007-70288-7](#) [00-054007-70290-0](#) [00-054007-70300-6](#) [00-054007-70304-4](#) [01-2900-1-04412](#) [00581P0075](#) [600TS-10](#) [604200-1](#) [605601-1](#) [60598-1-CUT-TAPE](#) [60617-1-C](#) [61314-6-C](#) [61810-3](#) [62149-1](#) [626-0194](#) [62-NBM-A](#) [62-SP](#) [63-S](#) [M55155/059I03](#)
[M55155/079C01](#) [M55155/099B03](#) [M55155/099H02](#) [M55155/109H01](#) [M55155/12XH05](#) [M55155/16XH02](#) [M55155/29-5S](#) [M55155/29XJ08](#)
[M55155/30-6S](#) [M55155/30-9S](#) [M55155/30XI09](#) [M6-14RSX](#) [696683-1](#) [696861-1](#) [696999-1](#) [M86700006](#) [D18-110B-C](#)