

修订 REV	标记 MARK	修改摘要 REV DESCRIPTION	签名 SIGNATURE	日期 DATE
A0		NEW DWG		2014-11-12

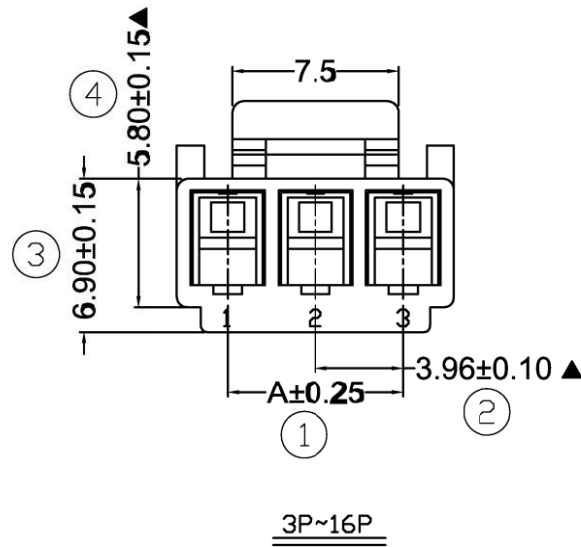
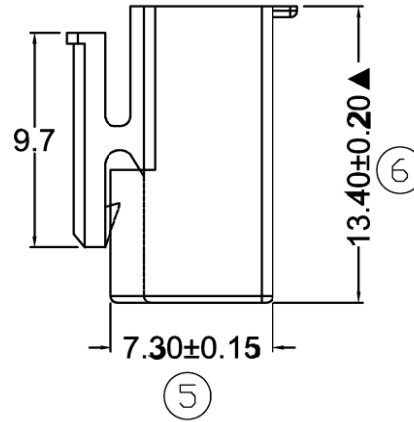
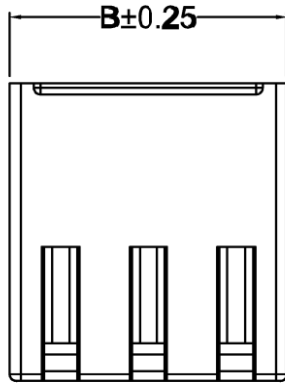
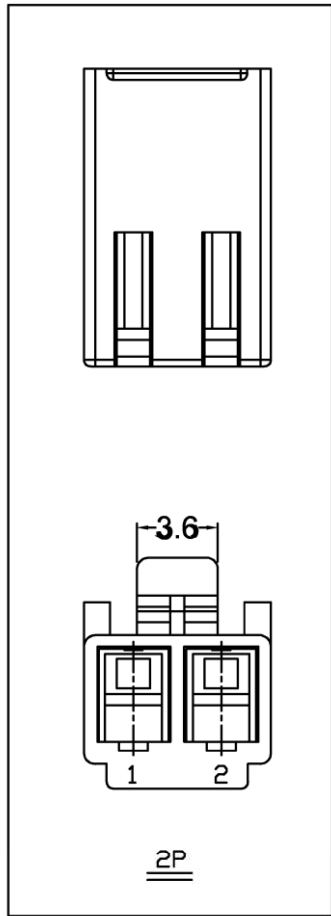

16	HDGC3963H-16P	59.40	64.00
15	HDGC3963H-15P	55.44	60.04
14	HDGC3963H-14P	51.48	56.08
13	HDGC3963H-13P	47.52	52.12
12	HDGC3963H-12P	43.56	48.16
11	HDGC3963H-11P	39.60	44.20
10	HDGC3963H-10P	35.64	40.24
9	HDGC3963H-9P	31.68	36.28
8	HDGC3963H-8P	27.72	32.32
7	HDGC3963H-7P	23.76	28.36
6	HDGC3963H-6P	19.80	24.40
5	HDGC3963H-5P	15.84	20.44
4	HDGC3963H-4P	11.88	16.48
3	HDGC3963H-3P	7.92	12.52
2	HDGC3963H-2P	3.96	8.56
Circuits	Part No.	Dimension(mm)	
		A	B

产品要求:

- 1、材质要求: PA66 UL 94-V0。
- 2、外观要求: 外观无变形、缺胶, 披锋≤0.08mm。
- 3、尺寸要求: 全尺寸符合检测标准, ▲为重点尺寸。

HDGC 深圳市华德共创科技有限公司
Shenzhen Huade co-create Technology Co., LTD
电话: 0755-27129737 传真: 0755-29940187

-TOLERANCES- UNLESS OTHERWISE SPECIFIED 公差参数表		TITLE: 产品名称: VH3.96H-XP	
X.X ± 0.30	X.X° ± 3°	APPD: 核准: 谢亮	PART NO: 产品编号: HDGC3963H-XP
X.XX ± 0.20	X.XX° ± 2°	CHECK: 校对: 王建业	DATE SCALE UNIT CODE NUMBER
X.XXX ± 0.10	X.XXX° ± 1°	DRAW: 绘图: 黄艳兰	2014-11-12 1:1 mm A006

修订 REV	标记 MARK	修改摘要 REVISION DESCRIPTION	签名 SIGNATURE	日期 DATE
A0		NEW DWG		2014-07-07

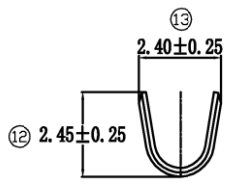
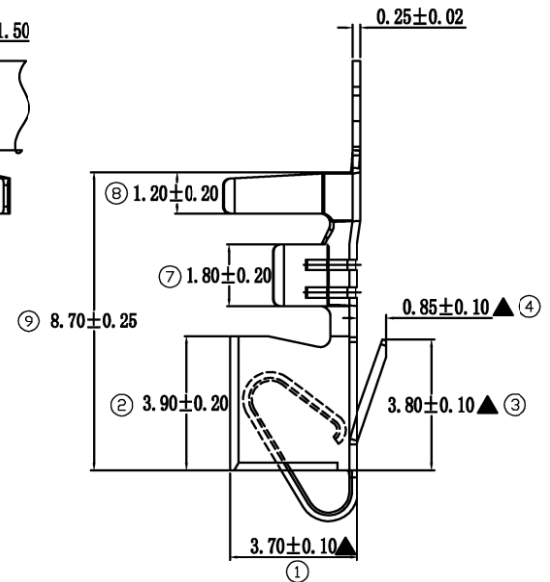
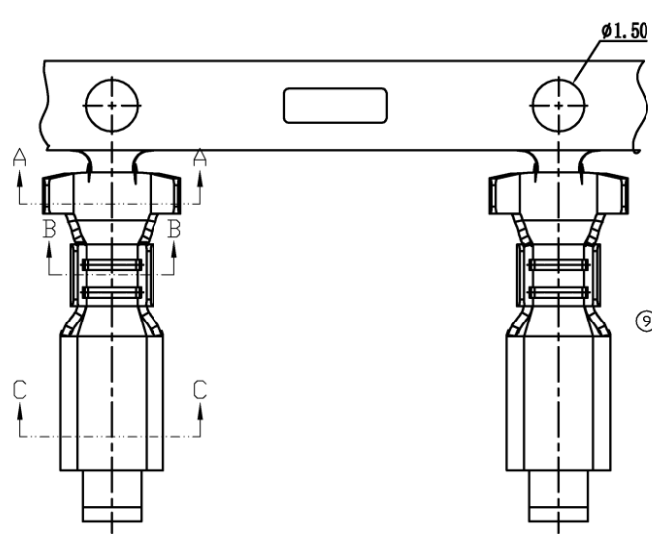

SECTION B-B

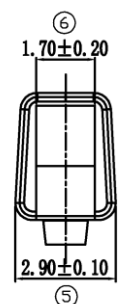

SECTION C-C

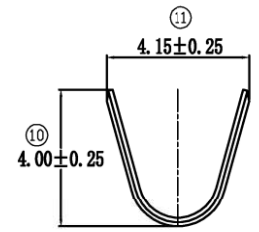

SECTION A-A

- 产品要求
1. 材质要求: 磷铜, C5191; T=0.25±0.02MM
 2. 电镀要求 先冲后镀 镀镍 Ni底

		深圳市华德共创科技有限公司 Shenzhen Huade co-create Technology Co.,LTD 电话: 0755-27129737 传真: 0755-29940187						
		-TOLERANCES- UNLESS OTHERWISE SPECIFIED 公差参数表				TITLE: 产品名称: VH3.96-T		
X.X	±0.30	X.X'	±3'	APPD: 核准: 谢亮	PART NO: 产品编号: HDGC3963-T			
X.XX	±0.30	X.XX'	±2'	CHECK: 校对: 王建业	DATE	SCALE	UNIT	CODE NUMBER
X.XXX	±0.10	X.XXX'	±1'	DRAW: 绘图: 黄艳兰	2014-07-07	1:1	mm	A001

X-ON Electronics

Largest Supplier of Electrical and Electronic Components

Click to view similar products for [Headers & Wire Housings](#) category:

Click to view products by [HDGC](#) manufacturer:

Other Similar products are found below :

[57102-F02-18ULF](#) [58102-G61-06LF](#) [582553-1](#) [009176003701906](#) [01.001.5753.1](#) [0050291907](#) [02.125.8002.8](#) [609-3404](#) [61062-3](#)
[CSU011177004](#) [622-0430](#) [622-3653LF](#) [63453-116](#) [636-1030](#) [636-1427](#) [636-3427](#) [636-4007](#) [641938-9](#) [644827-2](#) [65495-038](#) [65692-001LF](#)
[65781-018](#) [65781-047](#) [65817-010LF](#) [65817-015LF](#) [66207-023LF](#) [67095-007LF](#) [67601157](#) [68631-112](#) [68645-018](#) [699319-000](#)
[M90C108951C](#) [70.362.1628.0](#) [70-4210](#) [70-4226B](#) [70-4853B](#) [707-5028](#) [71.350.2428.0](#) [71961-016LF](#) [733-134](#) [733-162](#) [754199-000](#) [760-](#)
[3052](#) [80.063.4001.1](#) [800-90-001-10-001000](#) [800-90-010-10-002000](#) [801-43-002-10-013000](#) [801-43-006-10-002000](#) [803-41-018-10-001000](#)
[803-43-024-10-001000](#)