

修订 REV	标记 MARK	修改摘要 REVISION DESCRIPTION	签名 SIGNATURE	日期 DATE
A0		NEW DWG		2014-07-07

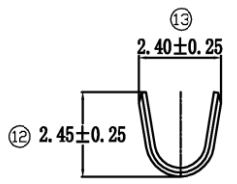

SECTION B-B

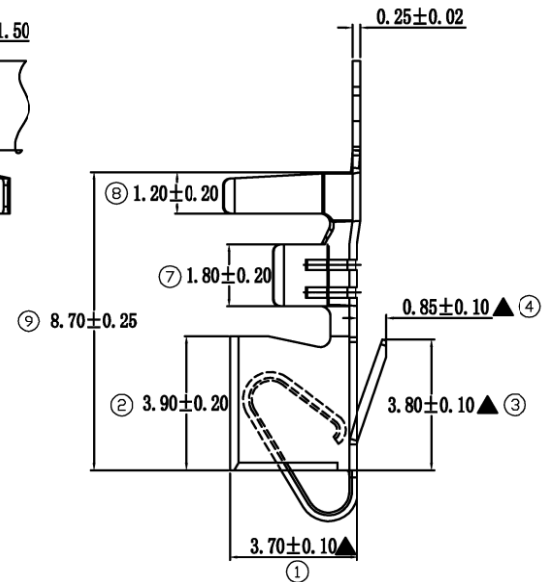
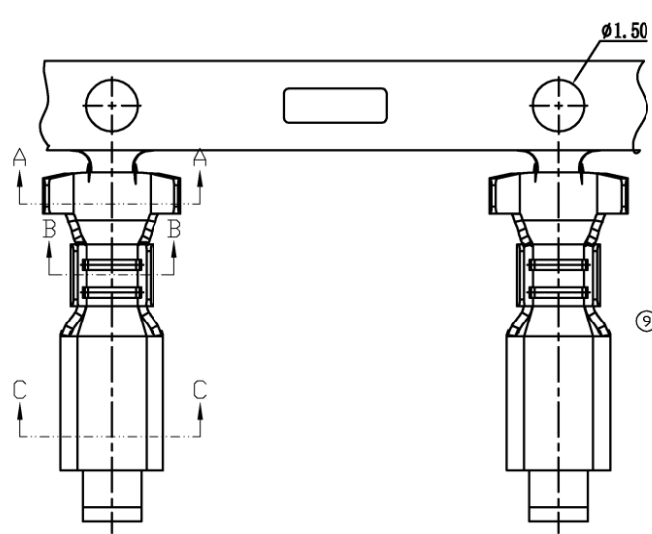
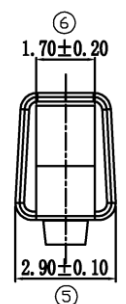

SECTION C-C

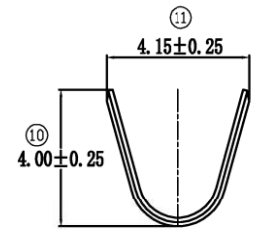

SECTION A-A

- 产品要求
1. 材质要求: 磷铜, C5191; $T=0.25 \pm 0.02MM$
 2. 电镀要求 先冲后镀 镀镍 Ni底



深圳市华德共创科技有限公司
Shenzhen Huade co-create Technology Co., LTD
电话: 0755-27129737 传真: 0755-29940187

-TOLERANCES- UNLESS OTHERWISE SPECIFIED 公差参数表		APPD: 核准: 谢亮	TITLE: 产品名称: VH3.96-T					
X.X	± 0.30		X.X'	$\pm 3'$	PART NO: 产品编号: HDGC3963-T			
X.XX	± 0.30	X.XX'	$\pm 2'$	DATE	SCALE	UNIT	CODE NUMBER	
X.XXX	± 0.10	X.XXX'	$\pm 1'$	DRAW: 绘图: 黄艳兰	2014-07-07	1:1	mm	A001

修订 REV	标记 MARK	修改摘要 REV DESCRIPTION	签名 SIGNATURE	日期 DATE
A0		NEW DWG		2014-11-12

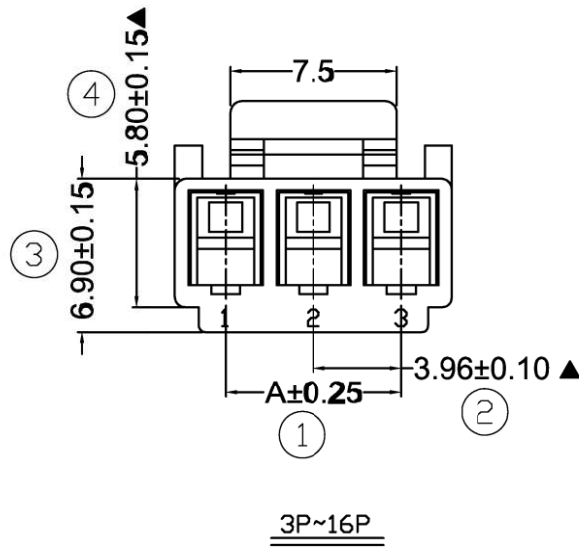
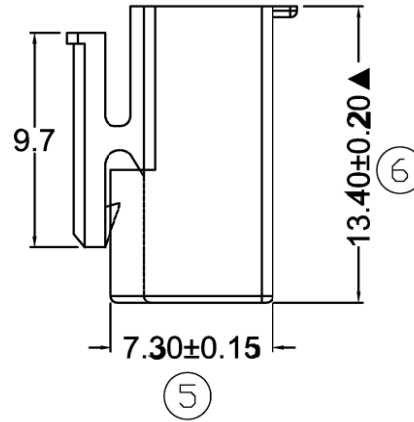
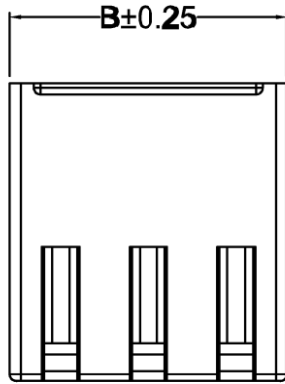
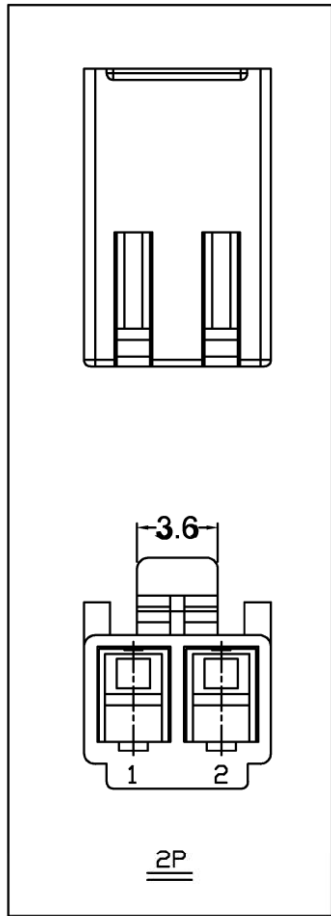

16	HDGC3963H-16P	59.40	64.00
15	HDGC3963H-15P	55.44	60.04
14	HDGC3963H-14P	51.48	56.08
13	HDGC3963H-13P	47.52	52.12
12	HDGC3963H-12P	43.56	48.16
11	HDGC3963H-11P	39.60	44.20
10	HDGC3963H-10P	35.64	40.24
9	HDGC3963H-9P	31.68	36.28
8	HDGC3963H-8P	27.72	32.32
7	HDGC3963H-7P	23.76	28.36
6	HDGC3963H-6P	19.80	24.40
5	HDGC3963H-5P	15.84	20.44
4	HDGC3963H-4P	11.88	16.48
3	HDGC3963H-3P	7.92	12.52
2	HDGC3963H-2P	3.96	8.56
Circuits	Part No.	Dimension(mm)	
		A	B

产品要求:

- 1、材质要求: PA66 UL 94-V0。
- 2、外观要求: 外观无变形、缺胶, 披锋≤0.08mm。
- 3、尺寸要求: 全尺寸符合检测标准, ▲为重点尺寸。



深圳市华德共创科技有限公司
Shenzhen Huade co-create Technology Co., LTD
电话: 0755-27129737 传真: 0755-29940187

-TOLERANCES- UNLESS OTHERWISE SPECIFIED 公差参数表		TITLE: 产品名称: VH3.96H-XP	
X.X ± 0.30	X.X° ± 3°	APPD: 核准: 谢亮	PART NO: 产品编号: HDGC3963H-XP
X.XX ± 0.20	X.XX° ± 2°	CHECK: 校对: 王建业	DATE SCALE UNIT CODE NUMBER
X.XXX ± 0.10	X.XXX° ± 1°	DRAW: 绘图: 黄艳兰	2014-11-12 1:1 mm A006

X-ON Electronics

Largest Supplier of Electrical and Electronic Components

Click to view similar products for [Terminals](#) category:

Click to view products by [HDGC](#) manufacturer:

Other Similar products are found below :

[00-054007-01074-6](#) [00-054007-70206-1](#) [00-054007-70210-8](#) [00-054007-70217-7](#) [00-054007-70228-3](#) [00-054007-70256-6](#) [00-054007-70316-7](#) [00-054007-49560-4](#) [00-054007-70209-2](#) [00-054007-70231-3](#) [00-054007-70241-2](#) [00-054007-70242-9](#) [00-054007-70246-7](#) [00-054007-70263-4](#) [00-054007-70288-7](#) [00-054007-70290-0](#) [00-054007-70300-6](#) [00-054007-70304-4](#) [01-2900-1-04412](#) [00581P0075](#) [600TS-10](#) [604200-1](#) [605601-1](#) [60598-1-CUT-TAPE](#) [60617-1-C](#) [61314-6-C](#) [61810-3](#) [62149-1](#) [626-0194](#) [62-NBM-A](#) [62-SP](#) [63-S](#) [M55155/059I03](#)
[M55155/079C01](#) [M55155/099B03](#) [M55155/099H02](#) [M55155/109H01](#) [M55155/12XH05](#) [M55155/16XH02](#) [M55155/29-5S](#) [M55155/29XJ08](#)
[M55155/30-6S](#) [M55155/30-9S](#) [M55155/30XI09](#) [M6-14RSX](#) [696683-1](#) [696861-1](#) [696999-1](#) [M86700006](#) [D18-110B-C](#)