

修订 REV A0	标记 MARK	修改摘要 REVISION DESCRIPTION NEW DRG	签名 SIGNATURE	日期 DATE 2016-03-12
-----------------	------------	---	-----------------	--------------------------

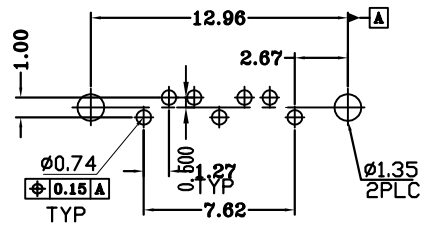

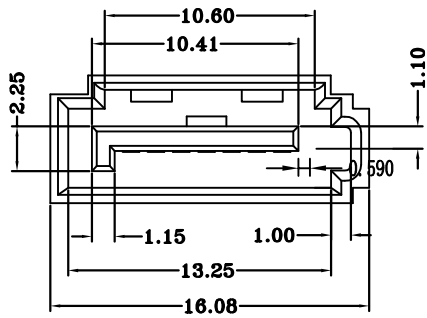
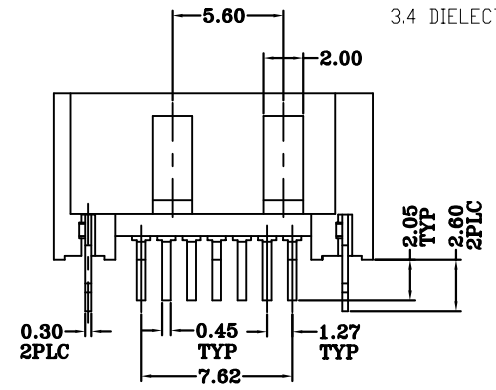
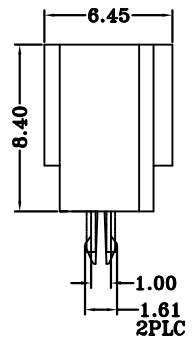
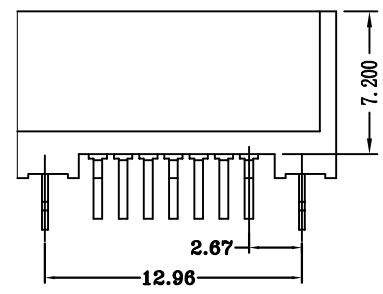

RECOMMEND PCB LAYOUT
PCB TOLERANCE: ±0.05

SPECIFICATION:
 1.MATERIAL:
 HOUSING:LCP 30% G/F UL 94V-0 or PA46 UL 94V-0
 COLOR:BLACK
 CONTACT:C5191-H,T=0.25mm
 2.FINISH:
 CONTACT:1u"or15u"
 / GOLD/TIN PLATING ON CONTACT AREA
 100u" MIN. TIN-LEAD PLATING ON SOLDER TAILS
 50u" MIN.NICKEL UNDERPLATING OVER ALL
 3.ELECTRICAL
 3.1 CURRENT RATING: 1.5A PER PIN MIN.
 3.2 CONTACT RESISTANCE: 30m OHM MAX.
 3.3 INSULATION RESISTANCE: 500M OHM MIN.
 3.4 DIELECTRIC WITHSTANDING VOLTAGE: 500VAC.



由 Autodesk 教育版产品制作

 深圳市华德共创科技有限公司 Shenzhen Huade co-create Technology Co.,LTD 电话: 0755-27111216 传真: 0755-29940187								
-TOLERANCES- UNLESS OTHERWISE SPECIFIED 公差参数表		 		TITLE: SATA 7P A型180度DIP全包 产品名称: 鱼叉脚				
X.X	±0.30	X.X°	±3°	APPD: 核准:	PART NO: 产品编号: HDGCYLSY-SATA-114			
X.XX	±0.20	X.XX°	±2°	CHECK: 校对: 王建业	DATE	SCALE	UNIT	CODE NUMBER
X.XXX	±0.10	X.XXX°	±1°	DRAW: 绘图: 黄艳兰	2016-03-12	1:1	mm	A001

由 Autodesk 教育版产品制作

X-ON Electronics

Largest Supplier of Electrical and Electronic Components

Click to view similar products for [I/O Connectors](#) category:

Click to view products by [HDGC](#) manufacturer:

Other Similar products are found below :

[571763P](#) [59811-0000](#) [61-168618-12P](#) [D20419-211](#) [D38999/20FJ24PA L/C](#) [76871-1403](#) [PCR-E36PM](#) [PCS-XE26LKA](#) [PCS-XES68MS+](#)
[G38A71314B](#) [DX40-50P\(55\)](#) [1571250010](#) [157-22500-3](#) [MS3471L14-19P L/C](#) [192991-0703](#) [FCN-260C008-A/L0](#) [FCN-260C024-AL0](#) [FCN-](#)
[261Z008](#) [2000314-1](#) [200331-1](#) [PCS-E28FS+](#) [PCS-XE26SLFD+](#) [PCS-XE26SLFDT+](#) [G730VID08BDC24](#) [HDR-E14MSG1+](#) [54182-0605](#)
[UE86K842720321](#) [38113800006](#) [DP3AR020WQ1R200](#) [DRA-26PC-F0R](#) [Z4.102.0680.0](#) [500-1040](#) [500-1052](#) [ZP-4008-66L](#) [DX40-20P\(55\)](#)
[5554841-1](#) [SM3100F14S-12P](#) [U90B3054061110](#) [U65-E04-4020](#) [557-262M2-06C](#) [60-042222-02S](#) [10099439-003C-TRLF](#) [226-0348-000](#)
[10137239-0011LF](#) [70.060.1028.0](#) [109029-ZZ](#) [HDR-E26MG1+](#) [SO-0715-02-01-02](#) [GT1-DA04CST](#) [231-303](#)