

修订	标记	修改摘要	签名	日期
REV	MARK	REVISION DESCRIPTION	SIGNATURE	DATE
AO		NEW DWG		2016-03-12

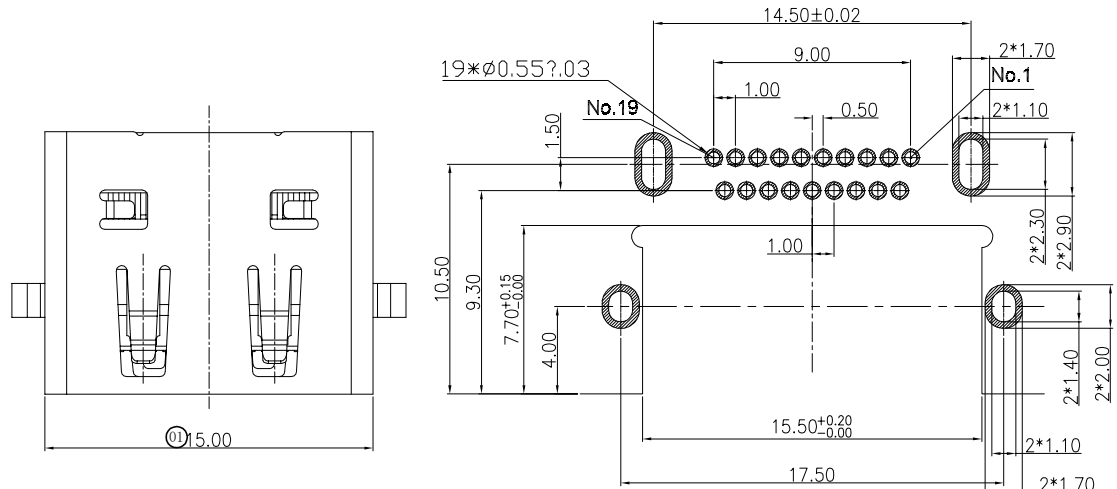

Recommended pcb layout (top view)  
(thickness=1.2±0.10mm) (tolerance ±0.05)

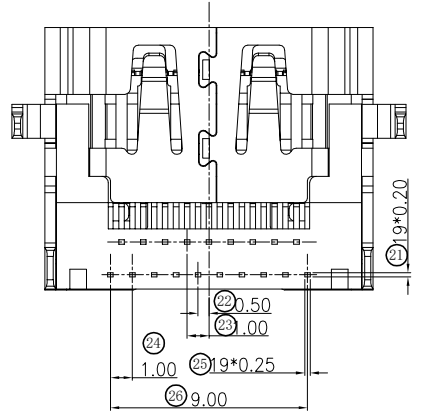

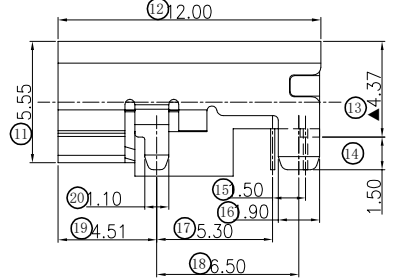
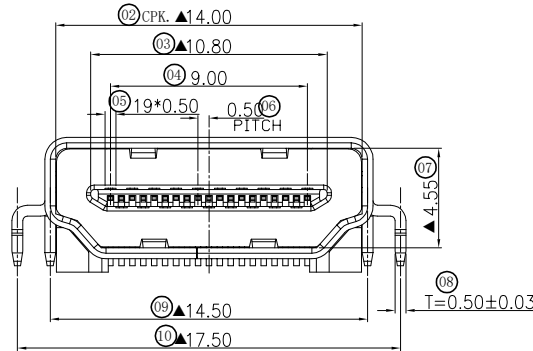

Note:

- Mechanical characteristics  
insertion force: 44.1N max  
withdrawal force: 9.8N min, 39.2N max  
mating cycle: 10000 cycles
- Electrical characteristics  
rating current: 0.5A  
rating voltage: 40V  
contact resistance: 10 milliohms max  
(excluding conductor resistance)  
insulation resistance:  
a, unmated: 100M Ohms min at 500 VDC  
b, mated: 10M Ohms min at 150 VDC  
dielectric withstanding voltage: 300V AC/1minute  
operating teperature: -20°C~+85°C  
storage temperature: -20°C~+65°C
- material:  
HOUSING: THERMOPLASTICS HIGH TEMP LCP+GLASS  
FIBER BLACK COLOR, UL94V-0  
CONTACT: Copper Alloy , T=0.20MM  
SHELL: Copper Alloy (SPCC) , T=0.5MM

由 Autodesk 教育版产品制作

由 Autodesk 教育版产品制作

 <b>深圳市华德共创科技有限公司</b> Shenzhen Huade co-create Technology Co.,LTD 电话: 0755-23304126 传真: 0755-29940187		TITLE: 产品名称: <b>HDMI AF正向沉板铁壳镀镍黑胶4.37</b>			
-TOLERANCES- UNLESS OTHERWISE SPECIFIED 公差参数表		 		PART NO: 产品编号: <b>HDMI-GD-112PWB</b>	
X.X ±0.30	X.X* ±3°	APPD: 核准:	DATE	SCALE	UNIT
X.XX ±0.20	X.XX* ±2°	CHECK: 校对: <b>王建业</b>	2016-03-12	1:1	mm
X.XXX ±0.10	X.XXX* ±1°	DRAW: 绘图: <b>黄艳兰</b>			CODE NUMBER A001

由 Autodesk 教育版产品制作

## X-ON Electronics

Largest Supplier of Electrical and Electronic Components

*Click to view similar products for [HDMI, Displayport & DVI Connectors](#) category:*

*Click to view products by [HDGC](#) manufacturer:*

Other Similar products are found below :

[30-528](#) [30-504](#) [33DVIR-24S1B](#) [47648-2000](#) [TC142X](#) [1932649-1](#) [HAGBH](#) [AABII](#) [ABIBG](#) [AAIBH](#) [52355](#) [XHLJQ-00026](#) [HDMI-019R](#)  
[G46M2013201AWEU](#) [ST-0277D00-052-142](#) [HC-PJ-320A-3P-D](#) [HC-PJ-3133-5P-D](#) [PJ-342](#) [141](#) [PJ-320A-4P DIP](#) [HC-PJ-325C-5P](#) [HC-PJ-](#)  
[320D-4P-S](#) [HC-PJ-3133-6P-S](#) [D-SUB-DR-9PCM-CB](#) [ST-0275S00-082-182](#) [HC-PJ-320A-4P-D](#) [HC-PJ-325A-5P](#) [HC-PJ-3134-6P-D](#) [HDR-](#)  
[HX-102DIP](#) [HDMI-GD-121PWB](#) [C2939191](#) [C2939584](#) [PJ-208](#) [PJ-2040](#) [PJ-3580A-6A](#) [PJ-399M](#) [PJ-3200A-3A](#) [PJ-328B-4B](#) [PJ-3930-7A](#)  
[PJ-615-5A](#) [PJ-332-6A](#) [KH-HDMI-0001](#) [KH-PJ-209-SMT](#) [KH-HDMI-0035-XK](#) [KH-PJ-328A-5P](#) [KH-PJ-322](#) [KH-PJ-327E-SMT](#) [KH-PJ-](#)  
[320A-5.6](#) [KH-HDR15P-F3.08](#) [KH-HDMI-0005A-SMT](#) [KH-HDMI-0021-JBS](#)