

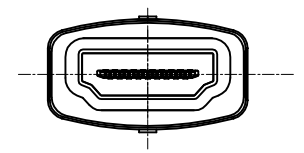

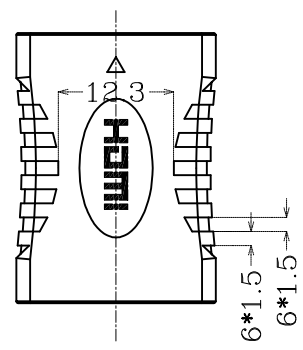

修订	标记	修改摘要	签名	日期
REV	MARK	REVISION DESCRIPTION	SIGNATURE	DATE
AO		NEW DWG		2016-03-12

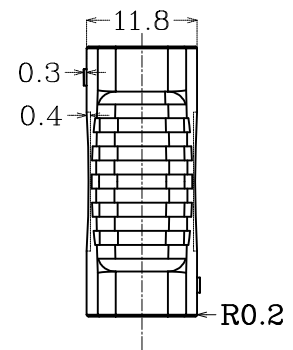
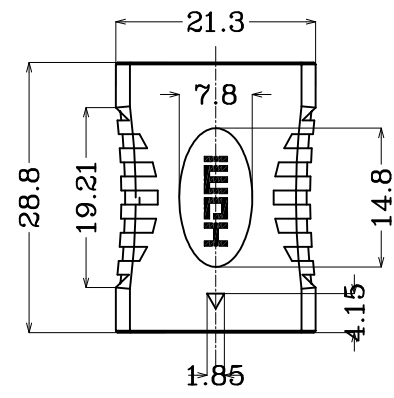
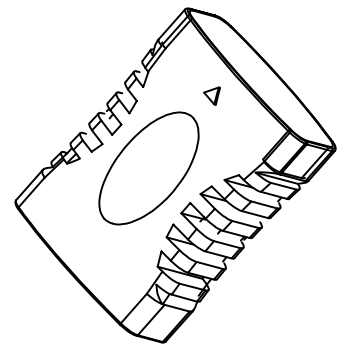
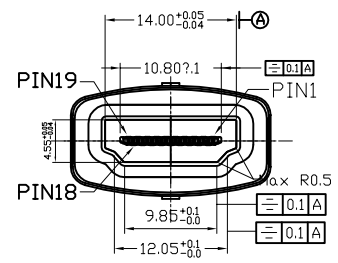

sPECIFICATION

- Electrical characteristics
  - Contact Current Rating:0.5 A
  - Dielectric Withstanding Voltange:300V AC
  - Insulation Resistance:a.Mate 100MΩ MIN at 500V/DC  
b.Unmate 10MΩ MIN at 150V/DC
  - Contact Resistance:30mΩ MAX
  - Temperature Range:-20° C to +85° C
- Mechanical
  - Mating Face:44.1N MAX
  - Unmatin Face:9.8N MIN;39.2N MAX
  - Durability:5000 Cycles
- material:
  - PVC:45Pa, UL94V-0;
  - HOUSING:THERMOPLASTICS HIGH TEMP LCP+GLASS  
FIBER BLACK COLOR, UL94V-0
  - CONTACT:BRASS , T=0.20MM
  - SHELL:C2680 , T=0.40MM
- PLATING:
  - CONTACT:1u" GOLD/TIN PLATING ON CONTACT AREA  
50u"MIN, NICKEL UNDERPLATING OVER ALL
  - Shell: G/F plated over 50u" NI min.

		深圳市华德共创科技有限公司 Shenzhen Huade co-create Technology Co.,LTD 电话: 0755-23304126 传真: 0755-29940187						
-TOLERANCES- UNLESS OTHERWISE SPECIFIED 公差参数表		 		TITLE: HDMI AF转接头铁壳镀镍黑胶 产品名称: 成型L=28.8				
X.X	±0.30	X.X*	±3°	APPD: 核准:	PART NO: 产品编号: HDMI-GD-139PWB			
X.XX	±0.20	X.XX*	±2°	CHECK: 校对: 王建业	DATE	SCALE	UNIT	CODE NUMBER
X.XXX	±0.10	X.XXX*	±1°	DRAW: 绘图: 黄艳兰	2016-03-12	1:1	mm	A001

由 Autodesk 教育版产品制作

由 Autodesk 教育版产品制作

## X-ON Electronics

Largest Supplier of Electrical and Electronic Components

*Click to view similar products for [D-Sub Standard Connectors](#) category:*

*Click to view products by [HDGC](#) manufacturer:*

Other Similar products are found below :

[015-0339-000](#) [015-0341-000](#) [015-0349-000](#) [015-0350-000](#) [015-8544-011](#) [015-8755-001](#) [017041-0005](#) [020419-0104](#) [609-25P](#) [609-9P](#)  
[M24308/2-23Z](#) [CT0-24-10SC](#) [CT0-36-3PC](#) [CT0E20-8PS](#) [CT0F16S-1PS](#) [CT0TA16-11SXCA232](#) [CT1E20-19SS](#) [CT2-10SL-3SC](#) [CT2-14S-2PCA34](#) [CT2-18-11PCAU](#) [CT2-22-19SC](#) [CT2-36-5PC](#) [CT6-10SL-3SC](#) [CT6-10SL-4SC](#) [CT6-14S-2SC](#) [CT6-16-12SC](#) [CT6-18-10PSA206](#)  
[CT6-18-10PSA232](#) [CT6-18-11PXSA206](#) [CT6-18-11PXSA232](#) [CT6-22-10PS](#) [CT6-24-5PC](#) [CT6-9767-18-8-18-4SS](#) [CT6E14S-5SC](#)  
[CT6E14SA7SC](#) [CT6E20-14SS](#) [CT6E22-14PC](#) [CT6E22-14PS](#) [CT6E22-19PS](#) [CT6E22-22PS](#) [CT6E24-10SC](#) [CT6F16S-1SC](#) [CT6FA10SL-4PS](#)  
[CT6LA20-19PC](#) [CT6M20-19SS](#) [CT6NSB4-20-8SS](#) [CT6TC14S-6SCAU](#) [CT6TC14S-7PS](#) [6STD15SCT99S40X](#) [6STF09PCM05B70X](#)