

REV	MARK	REVISION DESCRIPTION	SIGNATURE	DATE
AO		NEW DWG		2016-03-12

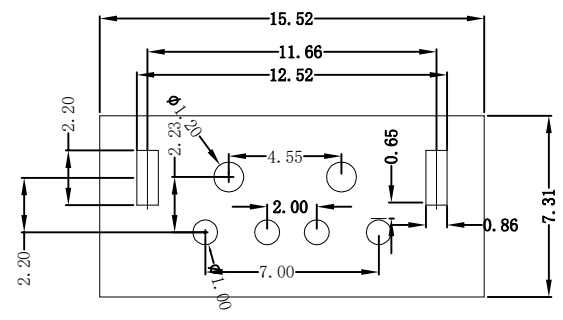
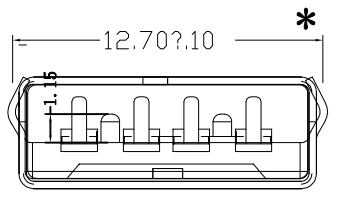
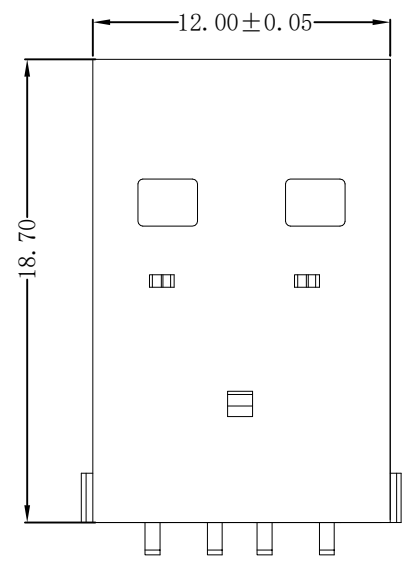
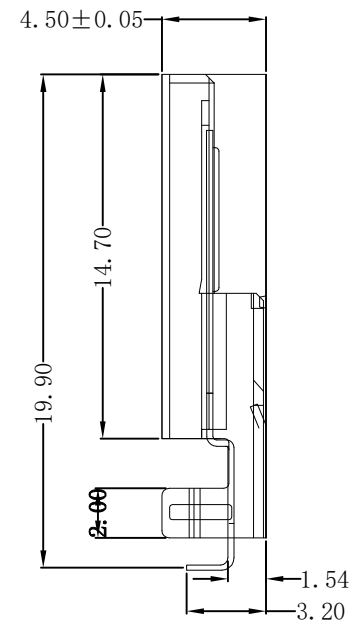
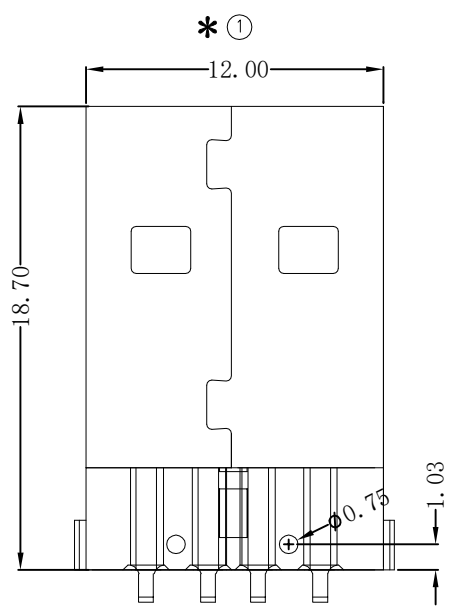

PCB LAYOUT

规格说明:Specifications:

电气特性:Electrical:

1. 额定电流: Current Rating  
1.5A/contact terminal
2. 额定电压: Voltage Rating  
30V DC
3. 接触阻抗: Contact Resistance  
30 milliohms MAX
4. 耐电压: Dielectric Withstanding Voltage:  
500 V AC AT Sea Level
5. 绝缘阻抗: Insulation Resistance:  
1000MEGA ohms MIN

物理性能:Mechanical:



1. 插拔力: Connector Mate and Unmate Force  
Mate force: 3.75kgf (MAX)  
Unmate force: 1.02kgf (MIN)
2. 端子保持力: Terminal Retention  
1.2kgf (MIN)

原材料:Material:

1. 塑胶: Housing:  
High Temperature Thermoplastics,  
UL 94V-0 PBT/LCP White/Black
2. 端子: Contact: Copper Alloy C2680
3. 外壳: Shell: Copper Alloy C2680/SPCC

电镀:Finish:

1. 端子: Contact: Plated Gold in Mating Area;  
Tin On Solder Tails
2. 外壳: Shell:  
Nickel Plating

		<b>深圳市华德共创科技有限公司</b> Shenzhen Huade co-create Technology Co.,LTD 电话: 0755-23304126 传真: 0755-29940187						
-TOLERANCES- UNLESS OTHERWISE SPECIFIED 公差参数表		 		TITLE: 产品名称: USB AM90度沉板弯脚有柱PBT白胶				
X.X	±0.30	X.X*	±3°	APPD: 核准:	PART NO: 产品编号: USB-ZL-109PWB			
X.XX	±0.20	X.XX*	±2°	CHECK: 校对: 王建业	DATE	SCALE	UNIT	CODE NUMBER
X.XXX	±0.10	X.XXX*	±1°	DRAW: 绘图: 黄艳兰	2016-03-12	1:1	mm	A001

由 Autodesk 教育版产品制作

由 Autodesk 教育版产品制作

## X-ON Electronics

Largest Supplier of Electrical and Electronic Components

*Click to view similar products for [USB Connectors](#) category:*

*Click to view products by [HDGC](#) manufacturer:*

Other Similar products are found below :

[950](#) [A-USB A-LP-SMT-C](#) [A-USB B-TOP-C](#) [MUSBD11135](#) [17-200721](#) [217450-1](#) [KMBVX-TH-5S-B30](#) [KUSBX-AS2N-W](#) [KUSBX-SMT2AP1S-W30](#) [935](#) [957](#) [30-498-6](#) [SK-60A-2](#) [1734082-1](#) [30-470](#) [30-489](#) [30-541](#) [MAB 5 S](#) [A-USB A-2P-C](#) [MIKROE-1451](#)  
[USBFTVSCCG](#) [1-1734084-2](#) [MUSBA81130](#) [NK-27-32SL](#) [NK-L8-22C-5/8](#) [10135326-001LF](#) [4198](#) [690-024-633-031](#) [UB-20PMFP-LC7001](#)  
[17-200011](#) [UB-20AFMM-LL7A01](#) [CAP-WCCMLPB1](#) [CAP-WCCMLPC1](#) [2274475-3](#) [914-614A2025S10200](#) [USB3FTV7SAGF059](#)  
[USB3FTV2SAZNF459](#) [USB3FTV7SAZNF459](#) [HYCW153-USBD05-500B](#) [HYCW148-USBD05-117B](#) [HYCW149-USBD05-740B](#)  
[HYCW214-USBA04-113B](#) [HYCW213-USBA04-113B](#) [KMMX-BSMT35S-1-B30TR](#) [2345986-1](#) [10082141-N340LF](#) [10117836-011LF](#)  
[GSB3C3133DSYHR](#) [GT-USB-2014-CWG1](#) [GT-USB-7010ANS](#)