



样品承认书

SPECIFICATION FOR APPROVAL

客 户: 超毅电子
(Customer)
品 名: 铝电解电容器
(Product Name)
型 号: VT1
(Series)
日 期: 2018年5月14日
(Date)

贵公司承认:
Approval Signature

批 准 :
Approved

审 核:
Checked

制 作:
Prepared

珠海华冠电容器有限公司
ZHUHAI LEAGUER CAPACITOR CO.,LTD.

地址: 广东省珠海市金鼎华冠科技工业园

Add:Higrand Scientific Industrial Park ,Jinding town ,Zhuhai,Guangdong

电话(TEL):(0756)3610222 传真(FAX):(0756)3610938

邮编(P.C.): 519085

网址(Internet): www.headcon.cn

Leaguer product specification content

华冠电容规格承认书目录

1、Parts lists 物料清单	P.2
2、Explanation of Leaguer Part Number 代码解释	P.3
3、VT1 Series	P.4 ~8
4、Marking 标示	P.8
5、Taping shapes & Dimensions 编带尺寸	P.9
6、Adhesion Test 编带粘接力测试	P.9
7、Details of Carrier Tape 编带补充说明	P.10
8、Dimensions of Outer Carton Box 外包装箱尺寸	P.10
9、Packing Quantity 包装数量	P.11
10、Fixing 安装	P.11

2、Explanation of Leaguer Part Number 代码解释

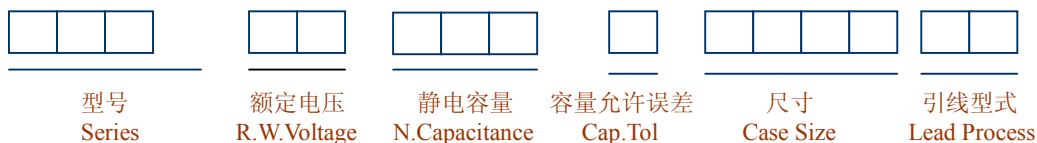

产品型号 Series	额定电压 R.W.Voltage (V)	代号 Code	标称电容量 Capacitance (μ F)	代号 Code	标称电容量 允许偏差 Cap.Tol	代号 Code	尺寸 Case Size	代号 Code	引线型式 Lead Process	代号 Code
VS1	4	0G	0.1	0R1	$\pm 5\%$	J	3×5	0305	直线切脚 Straight cut 成形切脚 Forming cut 折曲切脚 Kink cut 	C1
VS2	6.3	0J	0.22	R22	$\pm 10\%$	K	4×5	0405		
VT1	10	1A	0.33	R33			5×5	0505		
VTD	16	1C	0.47	R47	$\pm 20\%$	M	6.3×5	0605		
VZ1	25	1E	1	010			4×7	0407		
VBP	35	1V	2.2	2R2	Others	T	5×7	0507		
MS1	50	1H	3.3	3R3			6.3×7	0607		
MS2	63	1J	4.7	4R7			8×7	0807		
MT1	80	1K	10	100			5×11	0511		
MZ1	100	2A	22	220			6.3×11	0611		
MBP	160	2C	33	330			8×12	0812		
MLL	200	2D	47	470			8×14	0814		
MHF	250	2E	100	101			8×16	0816		
SS1	350	2V	220	221			8×20	0820		
ST1	400	2G	330	331			10×12	1012		
RS1	450	2W	470	471	10×16	1016				
RS2			1000	102	10×20	1020				
RT2			2200	222	10×25	1025				
RHR			3300	332	10×30	1030				
RT3			470000	474	13×14	1314				
RT4					13×20	1320				
SBP					13×25	1325				
SLZ					13×30	1330				
SLL					13×36	1336				
RNP					13×40	1340				
RHF					16×16	1616				
RSR					16×20	1620				
					16×25	1625				
					16×32	1632				
					16×36	1636				
					18×20	1820				
					18×26	1826				
					18×36	1836				
					18×40	1840				
					22×32	2232				
					22×36	2236				
					片式 SMD				F(1) F(2)	
					4×5.4	0405			片式产品 v-chip	V(1)
					5×5.4	0505				
					6.3×5.4	0605				
					6.3×7.7	0607				
					8×10.2	0810				

3、VT1 Series(105°C,1000H)

(1)、Standard Rating 基本参数

No.	Item	Ratings							
1	Temperature Range 使用温度范围	- 55~+105°C							
2	Rated Voltage Range 额定电压范围	6.3~63V							
3	Capacitance Range 标称容量范围	0.1~220 μ F							
4	Capacitance Tol 容量容许偏差	±20% (120Hz, 20°C)							
5	Surge Voltage 浪涌电压(V.DC)	R.V.	6.3	10	16	25	35	50	63
		S.V.	7.3	11.5	18.4	29	40	58	73

(2)、Electrical Requirements 电性能要求

1	Capacitance Tolerance 容量允许偏差	±20% at 120Hz,20°C																							
2	Operation Temperature Range 使用温度范围	6.3V~63V -55°C~+105°C																							
3	Leakage Current 漏电流	<p>After DC Voltage is applied to capacitor through the series protective resistance(1K Ω),and then terminal voltage may reach the rated working voltage. The leakage current when measured after 2 minutes (6.3~63V) shall be below the value of the following equation.</p> <p>将电容器串联 1K Ω 电阻后，施加额定直流电压 2 分钟，测量漏电流满足以下要求。</p> <div style="border: 1px solid black; padding: 5px; margin: 10px 0;"> <p>6.3~63V $I \leq 0.01CV$ or 3 μ A (取较大值) Whichever is greater</p> </div> <div style="border: 1px solid black; padding: 5px; margin: 10px 0;"> <p>Where I=Leakage Current(μ A) C=Capacitance(μ F) V=Rated DC Working Voltage(V)</p> </div>																							
4	Dissipation Factor 损耗角正切值 (Tan δ at 120Hz,20°C)	<table border="1" style="width: 100%; border-collapse: collapse; text-align: center;"> <thead> <tr> <th>Rated Voltage</th> <th>6.3</th> <th>10</th> <th>16</th> <th>25</th> <th>35</th> <th>50</th> <th>63</th> </tr> </thead> <tbody> <tr> <td>Tan δ (max)Φ4~6.3</td> <td>0.26</td> <td>0.20</td> <td>0.16</td> <td>0.14</td> <td>0.12</td> <td>0.12</td> <td>0.12</td> </tr> </tbody> </table>								Rated Voltage	6.3	10	16	25	35	50	63	Tan δ (max)Φ4~6.3	0.26	0.20	0.16	0.14	0.12	0.12	0.12
Rated Voltage	6.3	10	16	25	35	50	63																		
Tan δ (max)Φ4~6.3	0.26	0.20	0.16	0.14	0.12	0.12	0.12																		

5	Low Temperature Characteristics 低温特性 (at 120Hz)	<table border="1"> <tr> <td colspan="2">Rated Voltage</td> <td>6.3</td> <td>10</td> <td>16</td> <td>25</td> <td>35</td> <td>50</td> <td>63</td> </tr> <tr> <td>Impedance Ratio</td> <td>Z(-40°C)/ Z(+20°C)</td> <td>8</td> <td>6</td> <td>4</td> <td>4</td> <td>3</td> <td>3</td> <td>3</td> </tr> </table>							Rated Voltage		6.3	10	16	25	35	50	63	Impedance Ratio	Z(-40°C)/ Z(+20°C)	8	6	4	4	3	3	3
		Rated Voltage		6.3	10	16	25	35	50	63																
Impedance Ratio	Z(-40°C)/ Z(+20°C)	8	6	4	4	3	3	3																		
6	Rated Ripple Current 纹波电流 (at 120Hz,105°C)	见附表																								

(3)、附表 Case Size and Ripple Current 尺寸和纹波电流 (Our company's standard 本公司标准)

V μ F	6.3 (0J)		10 (1A)		16 (1C)		25 (1E)		35 (1V)		50 (1H)		63 (1J)	
	Size mm	Ripple current mA	Size mm	Ripple current mA	Size mm	Ripple current mA	Size mm	Ripple current mA	Size mm	Ripple current mA	Size mm	Ripple current mA	Size mm	Ripple current mA
0.1											4×5.4	1.0		
0.22											4×5.4	2.0		
0.33											4×5.4	3.0		
0.47											4×5.4	4.0		
1											4×5.4	8.0		
2.2											4×5.4	11		
3.3									4×5.4	13	4×5.4	13		
4.7					4×5.4	12	4×5.4	13	4×5.4	14	5×5.4	18		
											4×5.4	16		
10					4×5.4	20	5×5.4	20	5×5.4	24	6.3×5.4	28		
							(4×5.4)	(14)						
15													6.3×5.4	35
22	4×5.4	20	5×5.4	27	5×5.4	31	6.3×5.4	36	6.3×5.4	40	6.3×5.4	42		
			(4×5.4)	(21)	(4×5.4)	(22)	(5×5.4)	(25)	5×5.4	27				
33	5×5.4	27	5×5.4	34	6.3×5.4	40	6.3×5.4	44	6.3×5.4	50				
	4×5.4	22	4×5.4	23	(5×5.4)	(28)	5×5.4	29						
47	5×5.4	37	6.3×5.4	41	6.3×5.4	56	6.3×5.4	48	6.3×5.4	65				
	(4×5.4)	(25)	(5×5.4)	(30)	(5×5.4)	(31)								
68							6.3×5.4	58						
100	6.3×5.4	57	6.3×5.4	53	6.3×5.4	75								
	(5×5.4)	(39)	(5×5.4)	46										
150			6.3×5.4	59										
220	6.3×5.4	67	6.3×5.4	91										

(4)、Experiment the method and request 试验方法及要求

No.	Item 项目	Performance Characteristics 性能要求	Test 测试		
			Step	Test Temperature	Time
1	Characteristics at High and Low Temperature 高低温特性	<p><u>Step2 (阶段 2)</u></p> <p>Impedance Ratio: (阻抗比) Less than the item 5 Value of page 5 Ratio against step 1 相对于阶段 1 比值小于第 5 页第 5 项中的值</p> <p><u>Step4 (阶段 4)</u></p> <p>Leakage Current: (漏电流) Less than 800% of the value of item 3 at P4 小于或等于第 4 页第 3 项规定值 8 倍</p> <p>Capacitance Change: (容量变化) Within ±20% of the value in step1 与阶段 1 的比值变化率在±20%范围内</p>			
			1	20±2℃	3min
			2	-40±3℃	30min
			3	20±2℃	3min
			4	105±2℃	30min
			5	20±2℃	3min
2	Surge Voltage Test 浪涌测试	<p>Leakage Current: (漏电流) Less than the value of item 3 of page4 ≤第 4 页第 3 项规定值</p> <p>Capacitance Change: (容量变化) Within ±15% of the initial measured value 与初始 测量值比变化率±15%范围内</p> <p>Tangent of Loss Angle: (损耗角正切值) Less than 130% of specified value ≤第 4 页第 4 项规定值的 130%.</p>	<p>After surge voltage(the value of item 5 of P4) applied at a cycling rate of 30 seconds charge and 5.5 minutes discharge 1000 successive test cycle. Test temperature:15~35℃.</p> <p>对电容器施加浪涌电压, 每充电 30s, 放电 5min30sec, 连续循环 1000 次后测量。测试温度: 15~35℃。</p>		
3	Tensile Test 拔出力测试	<p>No broken and undamaged 无损坏</p>	<p>After fixing the capacitors, the terminals are pulled in vertical direction.</p> <p>Load is gradually increased until it reached 5N and held for 10 sec.</p> <p>将电容器固定, 在电容器的垂直方向上逐渐增加砝码至 5N, 然后持续 10s 结束。</p>		
4	Solderability 可焊性	<p>More than 95% of the terminal surface shall be covered with new solder. 引线端子表面 95%以上的面积附着新焊料。</p>	<p>Temperature: 235±2℃ (温度)</p> <p>Immersing Time: 2±0.1sec (浸入时间)</p> <p>Immersing Depth: Dip the terminal for Approx. 0.5~1mm thick 浸入深度: 浸入引线约 0.5~1mm</p> <p>Flux: Approx. 25% rosin in Ethanol 助焊剂: 约 25%的松香溶于酒精</p>		

5	<p>Vibration 振动</p>	<p>Capacitance: (容量) During test, measured value shall be stabilized (measured several times within 30 min. Before completion of test) 在测试的 30 分钟内, 观测电容量测试值无明显变化 Appearance: (外观) No significant change can be observe 无可见损伤 Capacitance change: (容量变化) Within $\pm 10\%$ of initial measured value 容量变化率在 $\pm 10\%$ 范围内</p>	<p>Frequency: 10~55Hz reciprocation for 1 min 频率: 10 到 55 Hz, 每分钟互换 Total amplitudes: 0.75mm 振幅: 0.75mm Direction and during of vibration: 3 orthogonal directions, Mutually each for 2hrs total 6hrs 在互相垂直的 3 个方向上, 每个方向振动 2 小时, 共 6 小时。</p>
6	<p>Solder Heat-Resistance Test 耐焊接热</p>	<p>Appearance: (外观) No significant change can be observe 无可见损伤 Capacitance change: (容量变化) Within $\pm 10\%$ of initial measured value 容量变化率在 $\pm 10\%$ 范围内</p>	<p>After reflow soldering the capacitor shall be restored to 20°C within two hours or over an hour. 将电容器通过回流焊后, 在室温恢复 1~2 小时。</p>
7	<p>Solvent Resistance of the Marking 标示耐溶剂性</p>	<p>There shall be no damage end legibly marked. Marking can be deciphered easily. 标示应清晰可辨</p>	<p>Class of Reagent: Isopropyl Alcohol 试剂: 异丙醇 Test Temperature: 20~25°C 温度: 20~25°C Immersing Time: 5 minutes 浸入时间: 5 分钟</p>
8	<p>Humidity Test 潮湿试验</p>	<p>Leakage Current: (漏电流) Less than the value of item 3 of page 4 \leq 第 4 页第 3 项规定值 Capacitance Change: (容量变化) Within $\pm 20\%$ of the initial measured value 与初始测量值比变化率在 $\pm 20\%$ 范围内。 Tangent of Loss Angle: (损耗角正切值) Less than 120% of the value of item 4 of page 4 \leq 第 4 页第 4 项规定值的 1.2 倍 Appearance: (外观) No significant change can be observed. 无可见损伤</p>	<p>Capacitors shall be exposed for 500\pm6hrs in an atmosphere of 90~95% R.H. at 40°C. And then the capacitor shall be subjected to standard atmospheric conditions for 1-2 hours, after which measurements shall be made. 电容器放置在温度 40°C、湿度 90~95% 的环境下 500\pm6 小时, 然后放置在标准环境中恢复 1-2 小时</p>
9	<p>High Temperature Load Life Test 高温负荷寿命</p>	<p>Leakage Current: (漏电流) Less than the value of item 3 of page 4 \leq 第 4 页第 3 项规定值 Capacitance Change: (容量变化) Within $\pm 20\%$ of the initial measured value 与初始测量值比变化率在 $\pm 20\%$ 范围内。 Tangent of Loss Angle: (损耗角正切值) Less than 200% of the value of item 4 of page 4 \leq 第 4 页第 4 项规定值的 2 倍 Appearance: (外观) No significant change can be observed. 无可见损伤</p>	<p>Test Temperature 温度: 105\pm2°C Test Duration: 1000 hours 试验持续时间: 1000 小时 Applied Voltage: Rated Voltage 施加电压: 额定电压 After subjected to the test, the capacitors shall be left at the room temperature for 16 hours prior to the measurement. 试验完成后, 电容器在测量前应在室温中恢复 16 小时。</p>

10	High Temperature Unload Life Test 高温储存	<p>Leakage Current: (漏电流) Less than 200% of the value of item 3 of page 4 ≤第4页第3项规定值的2倍</p> <p>Capacitance Change: (容量变化) Within ±20% of the initial measured value 与初始测量值比变化率在±20%范围内</p> <p>Tangent of Loss Angle: (损耗角正切值) Less than 200% of specified value of item 4 of page 4 ≤第4页第4项规定值的2倍</p> <p>Appearance: (外观) No significant change can be observed. 无可见损伤</p>	<p>Test Temperature 温度: 105±2℃</p> <p>Test Duration: 1000 hours 试验持续时间: 1000 小时</p> <p>After subjected to the test, the capacitors shall be left at the room temperature for 16 hours prior to the measurement. 试验完成后, 电容器在测量前应在室温中恢复 16 小时。</p>
----	---	--	--

(5)、Dimension & Appearance 外形尺寸(mm)

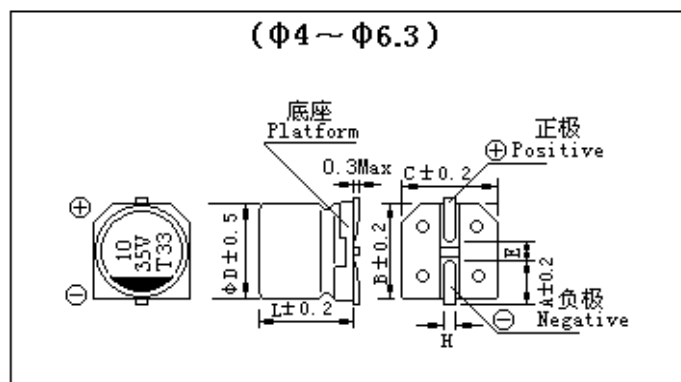

	φ4×5.4	φ5×5.4	φ6.3×5.4
A	1.8	2.1	2.4
B	4.3	5.3	6.6
C	4.3	5.3	6.6
E	1.0	1.3	2.2
L	5.4	5.4	5.5
H	0.5~0.9		

4、Marking 标示

a) Following items shall be marked on the body of capacitor. The marking color is black.
电容器的本体上印刷以下内容, 颜色为黑色。

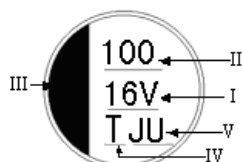

- i. Rated Voltage 额定电压
- ii. Capacitance 额定容量
- iii. Negative Polarity 负极标示
- iv. Series 系列代码
- v. Code 代码

b) Following items should be marked on the taping reel.

电容器的编带包装盘上印刷以下内容。

- i. Rated Voltage and Capacitance 额定电压&容量
- ii. Manufacture's Name 制造商名称
- iii. Customer's Part Number(if request) 客户料号 (客户有要求时)
- iv. Series Mark 系列名称
- v. Lot Number 制造批号
- vi. Packing quantity 编带数量

5、Taping shapes & Dimensions 编带尺寸 (单位: mm)

- Carrier tape 编带

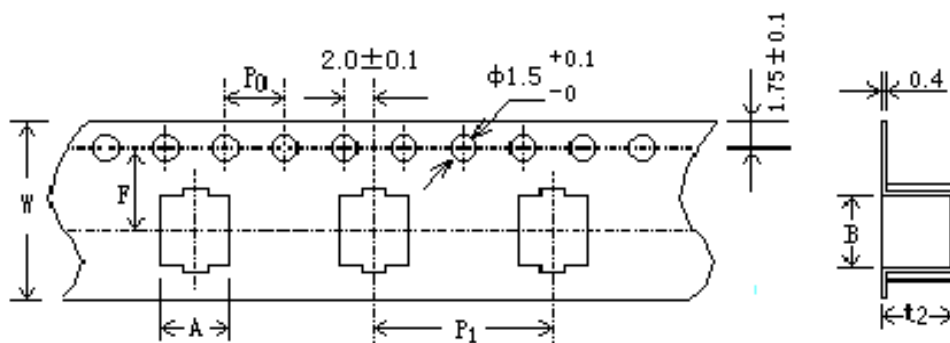

$\phi D \times L$	$W \pm 0.3$	$A \pm 0.2$	$B \pm 0.2$	$F \pm 0.1$	$P_1 \pm 0.1$	$t_2 \pm 0.2$
$\phi 4 \times 5.4$	12.0	4.7	4.7	5.5	8.0	5.8
$\phi 5 \times 5.4$	12.0	6.0	6.0	5.5	12.0	5.8
$\phi 6.3 \times 5.4$	16.0	7.0	7.0	7.5	12.0	5.8

- Reel 编带包装盘

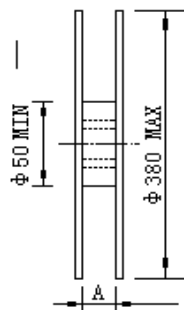
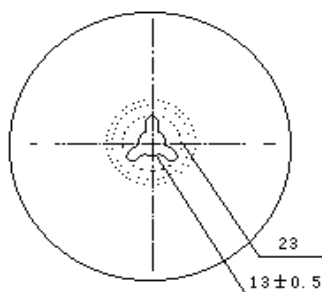

ϕD	4	5	6.3
A	14	14	18

6、Adhesion Test 编带粘接力测试

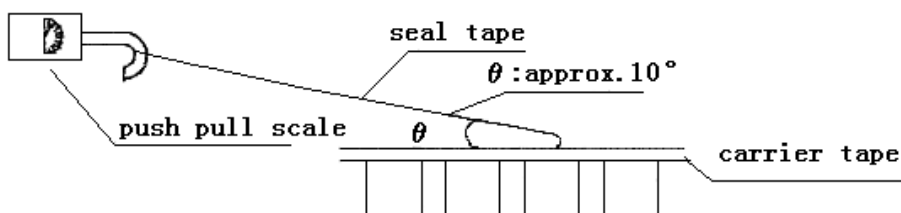

Reasonable pulling strength: 0.092~0.882N; Pulling speed: 200~300mm/min.

适当的粘接力强度: 0.092~0.882N; 测试速度: 200~300mm/min。

7、Details of Carrier Tape 编带补充说明

(1) 收料卷动开始时 Reeling begin:

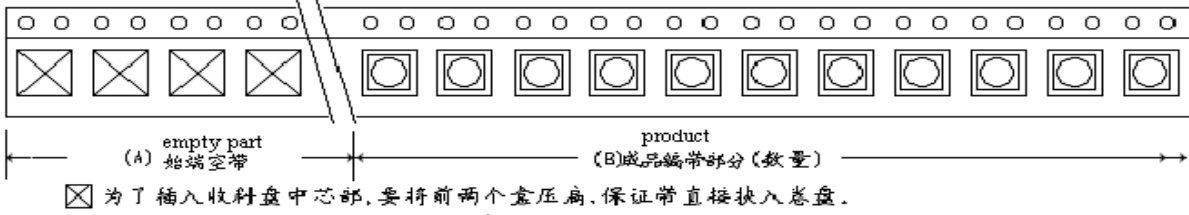

(2) 收料卷动结束时 Reeling over:

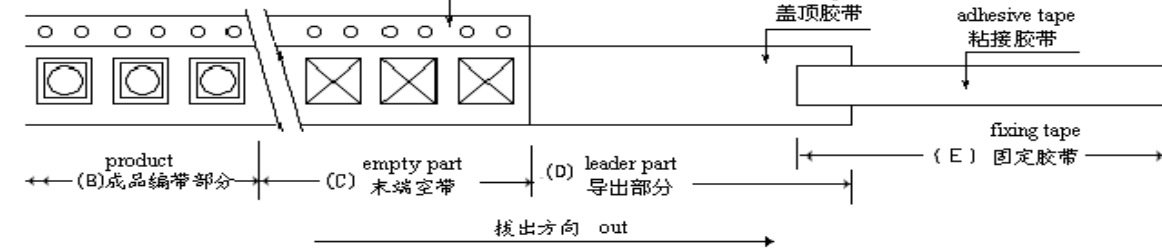

Last reeling empty part of carrier tape shall be more than 10cm.

每盘编带产品的末端空带不少于 10cm.

Leader part of seal tape shall be more than 20cm.

结尾处盖顶胶带的导出部分不少于 20cm.

Adhesive tape fixing the end of the leader part shall be approx. 10cm.

粘接盖顶胶带的固定胶带长约 10cm.

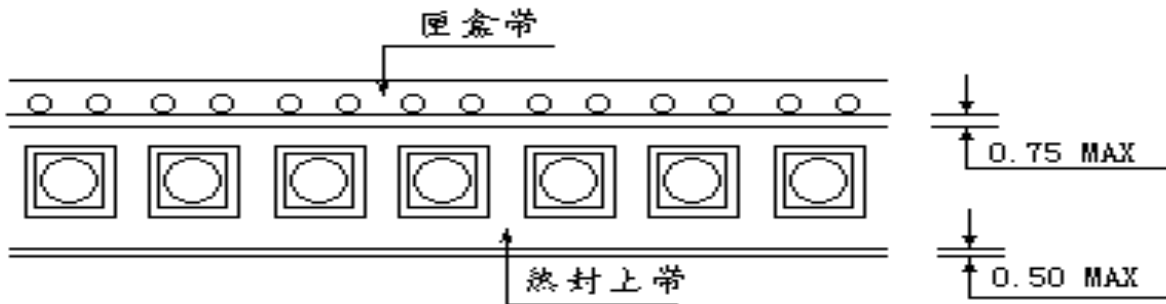

Deviation between carrier tape and seal tape shall be less than 0.5mm

盖顶胶带的偏移不超过 0.5mm.

Seal tape shall not cover on the feeling hoes .

盖顶胶带不可覆盖导带孔的部分.

8、Dimensions of Outer Carton Box 外包装箱尺寸

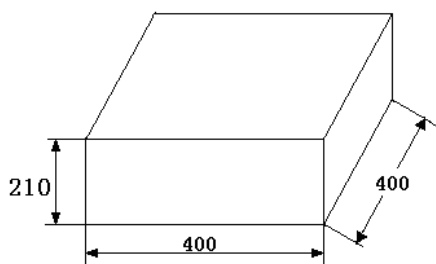

Drawing 3

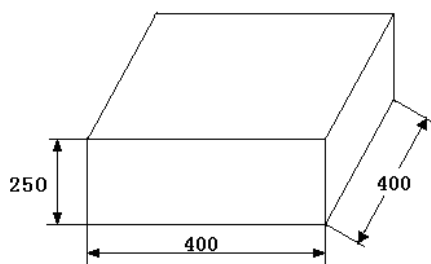

Drawing 4

9、Packing Quantity 包装数量

Size	Quantity/one reel/(pcs)	Quantity/one box/(pcs)	Outer box size
$\phi 4 \times 5.4$	2000	20000	Drawing 3
$\phi 5 \times 5.4$	1000	10000	Drawing 3
$\phi 6.3 \times 5.4$	1000	10000	Drawing 4

10、Fixing 安装

Recommend land size 建议安装尺寸

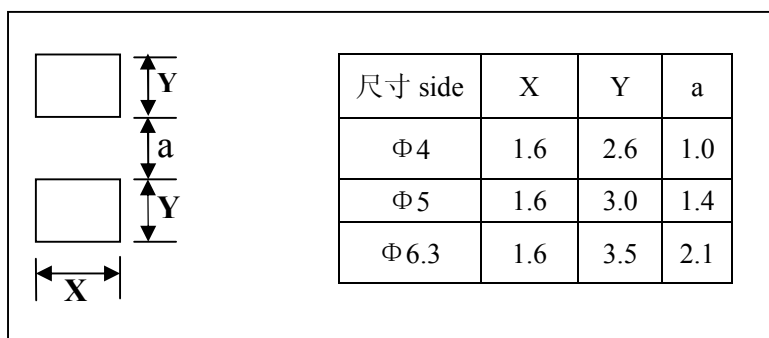

■ 回流焊温度与时间曲线 Temperature/ Time profile

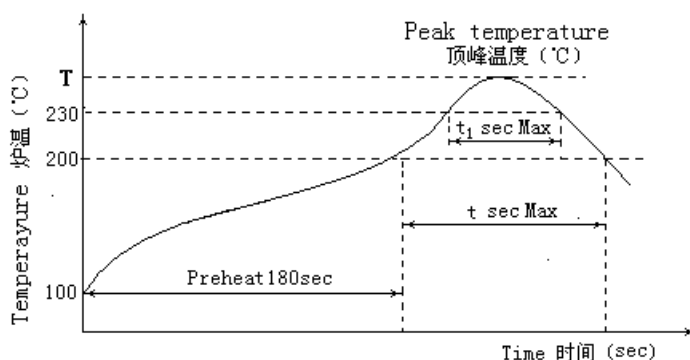

■ 不同壳号的焊接温度及时间 Allowable Range of Peak Temperature

Size	T(°C)	t (second)	t ₁ (second)
$\phi 4 \sim \phi 6.3$	255	100	50

- Preheat shall be made at 100°C ~ 200°C and for maximum 180 seconds.
100~200°C的预热时间不超过180秒。
- If capacitors are subject to the conditions other than the allowable range of reflow, please contact to us.
如果电容器承受的条件与回流焊的允许范围不同, 请与我们联系。

X-ON Electronics

Largest Supplier of Electrical and Electronic Components

Click to view similar products for [Aluminium Electrolytic Capacitors - SMD category](#):

Click to view products by [HEADCON manufacturer](#):

Other Similar products are found below :

[EEV-FK1E332W](#) [ULV2H1R8MNL1GS](#) [MAL214099813E3](#) [CA025M4R70REB-0405](#) [HUB1800-S](#) [34610](#) [RYK-50V101MG5TT-FL](#)
[107AXZ016MQ5](#) [RVJ-50V101MH10U-R](#) [EMVH101GRA221MMN0S](#) [MAL214097402E3](#) [MAL215375471E3](#) [MAL224699909E3](#)
[MAL224699813E3](#) [MAL215099014E3](#) [MAL215099017E3](#) [MAL215099117E3](#) [MAL215099818E3](#) [AEH1010331M025R](#)
[AEA1010221M035R](#) [AEH1010221M025R](#) [AEA1010102M016R](#) [AEA0810331M025R](#) [AEA1213102M025R](#) [AEA1213331M050R](#)
[AEH1012471M016R](#) [MAL213967339E3](#) [ZSC00AF2211EARL](#) [VB1E100MB054000CE0](#) [RVT0J471M0607](#) [RVT1000UF10V34RV0081](#)
[XT100UF50V90RV0067](#) [RVE100UF16V67RV0046](#) [RST22UF35V025](#) [RVT100UF16V67RV0120](#) [XT47UF50V90RV0082](#)
[XT22UF50V90RV0083](#) [RST22UF50V026](#) [RST10UF16V013](#) [RST100UF25V004](#) [RST100UF35V009](#) [RST47UF25V035](#) [RST47UF50V038](#)
[RST220UF25V019](#) [RSL220UF25V021](#) [XT10UF25V90RV0068](#) [FZ100UF50V90RV0066](#) [RST100UF16V003](#) [XT100UF10V90RV0060](#)
[XT100UF16V90RV0061](#)