

Features

- High input voltage (up to 50V)
- Low Power Consumption: 2 μ A (Typ)
- Maximum Output Current: 400mA
- Voltage drop: 350mV@100mA(3.3V)
- Good Transient Response
- Output voltage accuracy: tolerance $\pm 2\%$
- SOT89-3, SOT23-5 and SOT89-5 package
- PSRR: 85dB@1KHz

Applications

- Portable, Battery Powered Equipmpm
- Microcontroller Applications
- Smoke detector and sensor
- Audio/Video equipment
- Weighting Scales
- Home Automation

General Description

The HE2210 series is a high voltage, ultralow-power, low dropout voltage regulator. The device can deliver 400mA output current with a dropout voltage of 350mV and allows an input voltage as high as 50V. The typical quiescent current is only 2 μ A. The device is available in fixed output voltages of 2.5,2.8,3.0,3.3,3.6 and 5.0V. The device features integrated short-circuit and thermal shutdown protection. Although designed primarily as fixed voltage regulators, the device can be used with external components to obtain variable voltages.

Selection Table

Part No.	Output Voltage	Package	Marking
HE2210M533R	3.3V	SOT23-5	AH-3C
HE2210M550R	5.0V	SOT23-5	AH-5J
HE2210P533R	3.3V	SOT89-5	AH33C
HE2210P550R	5.0V	SOT89-5	AH50C
HE2210PCxxR	XX	SOT89-3	AHXBX
HE2210PxxR	XX	SOT89-3	AH-XX

Note: "XX" stands for output voltages.

Application Circuits

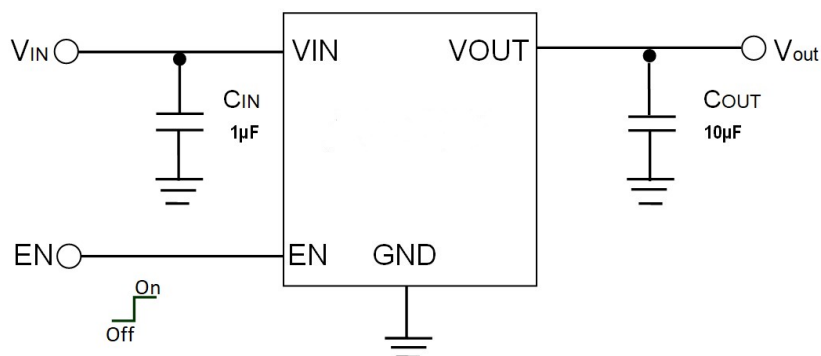

Pin Assignment

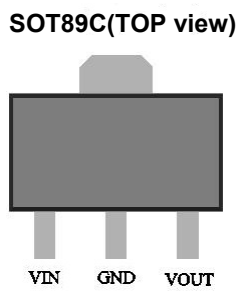
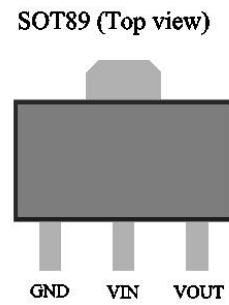
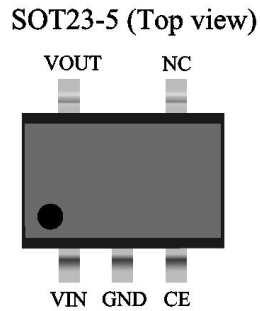
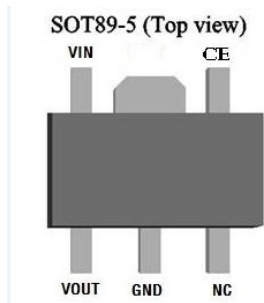

Functional Block Diagram

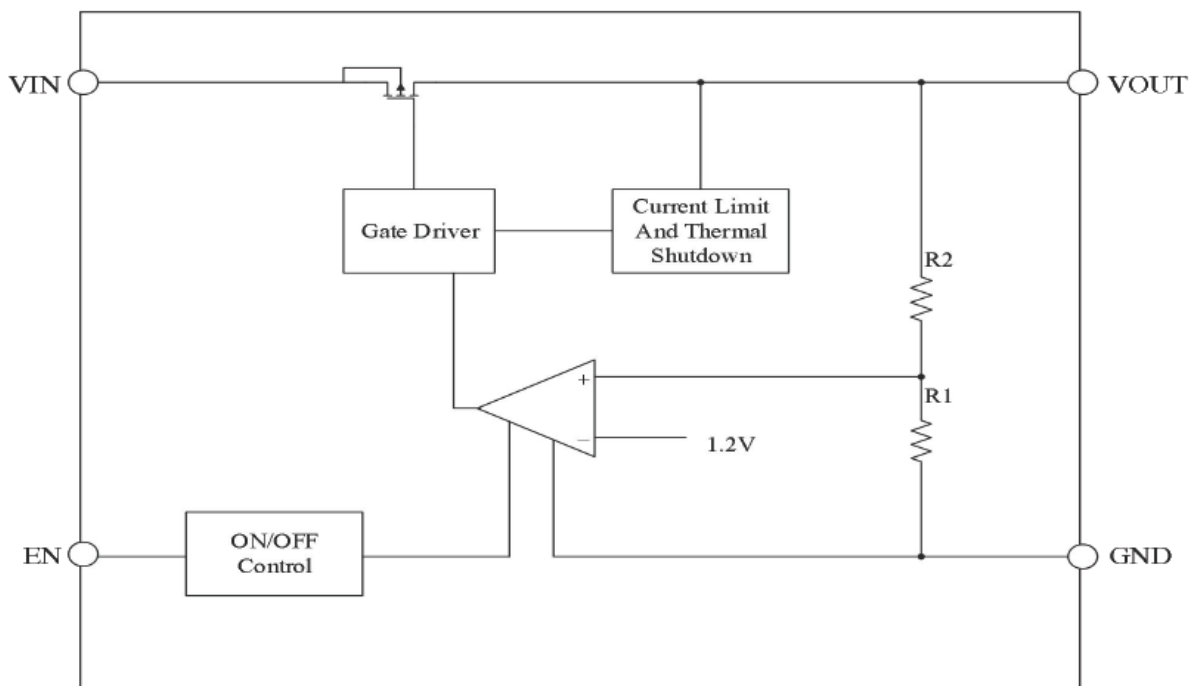

Absolute Maximum Ratings ⁽¹⁾⁽²⁾

Parameter		Symbol	Maximum Rating	Unit
Input Voltage		V _{IN}	V _{SS} -0.3~V _{SS} +50.0	V
		V _{OUT}	V _{SS} -0.3~V _{SS} +6.0	V
Output Current		I _{OUT}	400	mA
Power Dissipation	SOT23-5	P _d	400	mW
	SOT89		500	
Thermal Resistance	SOT23-5	R _{θJA} ⁽³⁾	250	°C/W
	SOT89		200	°C/W
Operating Temperature		T _{opr}	-40~85	°C
Storage Temperature		T _{stg}	-40~125	°C
Soldering Temperature & Time		T _{solder}	260°C, 10s	

Note (1): Exceeding these ratings may damage the device.

Note (2): The device is not guaranteed to function outside of its operating conditions

Note (3): The package thermal impedance is calculated in accordance to JESD 51-7.

ESD Ratings

Item	Description	Value	Unit
V _(ESD-HBM)	Human Body Model (HBM) ANSI/ESDA/JEDEC JS-001-2014 Classification, Class: 2	±4000	V
V _(ESD-CDM)	Charged Device Mode (CDM) ANSI/ESDA/JEDEC JS-002-2014 Classification, Class: C0b	±200	V
I _{LATCH-UP}	JEDEC STANDARD NO.78E APRIL 2016 Temperature Classification, Class: I	±150	mA

ESD testing is performed according to the respective JESD22 JEDEC standard. The human body model is a 100 pF capacitor discharged through a 1.5kΩ resistor into each pin. The machine model is a 200pF capacitor discharged directly into each pin.

Recommended Operating Conditions

Parameter	MIN.	MAX.	Units
Supply voltage at V _{IN}	---	30	V
Operating junction temperature range, T _j	-40	125	°C
Operating free air temperature range, T _A	-40	85	°C

Note : All limits specified at room temperature (T_A = 25°C) unless otherwise specified. All room temperature limits are 100% production tested. All limits at temperature extremes are ensured through correlation using standard Statistical Quality Control (SQC) methods. All limits are used to calculate Average Outgoing Quality Level (AOQL).

Electrical characteristics

(At $T_A=25^{\circ}\text{C}$, $C_{IN}=1\mu\text{F}$, $V_{IN}=V_{OUTNOM}+1.0\text{V}$, $C_{OUT}=10\mu\text{F}$, unless otherwise noted)

Symbol	Parameter	Test Conditions	Min	Typ.	Max	Units
V_{IN}	Input Voltage		3.0	—	50	V
I_Q	Quiescent Current	$V_{IN}=12\text{V}$ No load	—	2.0	2.3	μA
V_{OUT}	Output Voltage	$V_{IN}=12\text{V}$ $I_{OUT}=10\text{mA}$	-2.0		+2.0	%
I_{SD}	Shutdown Ground Current	$V_{IN}=0\text{V}$	—	—	0.1	μA
I_{LEAK}	V_{OUT} Shutdown Leakage Current	$V_{OUT}=0\text{V}$	—	—	0.1	μA
I_{OUT_MAX}	Output Current		—	400	—	mA
V_{DROP}	Dropout Voltage(1)	$I_{OUT}=10\text{mA}$ $V_{IN}=V_{OUTNOM}-0.1\text{V}$	—	35	—	mV
		$I_{OUT}=100\text{mA}$ $V_{IN}=V_{OUTNOM}-0.1\text{V}$	—	350	—	mV
ΔLOAD	Load Regulation	$V_{IN}=V_{OUT}+1\text{V}$ $1\text{mA}\leq I_{OUT}\leq 100\text{mA}$	—	40	—	mV
ΔLINE	Line Regulation	$I_{OUT}=1\text{mA}$, $V_{OUTNOM}+0.5\text{V}\leq V_{IN}\leq 50\text{V}$	—	0.01	—	%/V
PSRR	Power Supply Rejection Ratio	$V_{IN}=12\text{V}$, $I_{OUT}=10\text{mA}$ $f=1\text{KHz}$, $V_{OUT}=3.3\text{V}$	—	85	—	dB
V_{IH}	EN Threshold Voltage,Logic-High	$V_{IN}=5.0\text{V}$, $I_{OUT}=1\text{mA}$	1.0	—	—	V
V_{IL}	EN Threshold Voltage,Logic-Low	$V_{IN}=5.0\text{V}$	—	—	0.4	V
I_{LIMIT}	Current Limit	$V_{IN}=V_{OUT}+1\text{V}$	300	450	—	mA
I_{SHORT}	Short /Start Load Current	$R_L=1\Omega$		100		mA
ϵ_{NO}	Output Noise Voltage	10Hz to 100kHz $C_{OUT}=1\mu\text{F}$	—	100	—	μVRMS
T_{SD}	Thermal Shutdown Temperature		—	150	—	$^{\circ}\text{C}$
ΔT_{SD}	Thermal Shutdown Hysteresis		—	20	—	$^{\circ}\text{C}$

Note: *1 Dropout Voltage is the voltage difference between the input and the output at which the output voltage drops 2% below its nominal value.

Typical Performance Characteristics:

Test Condition: TA=25°C, I_{out}=1mA, C_{OUT}=10uF, unless otherwise noted

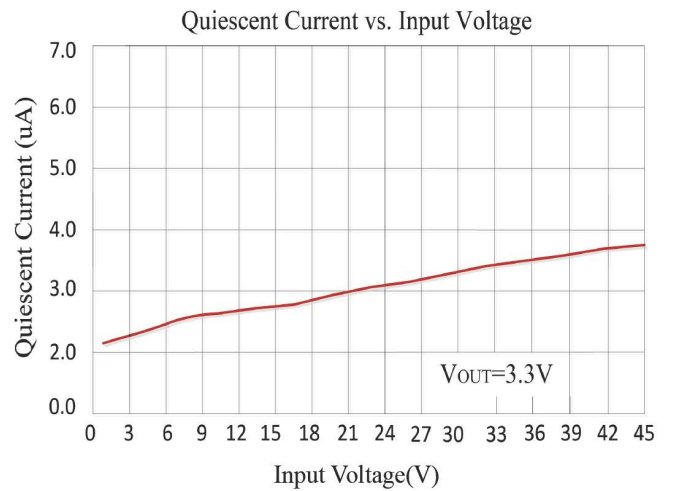
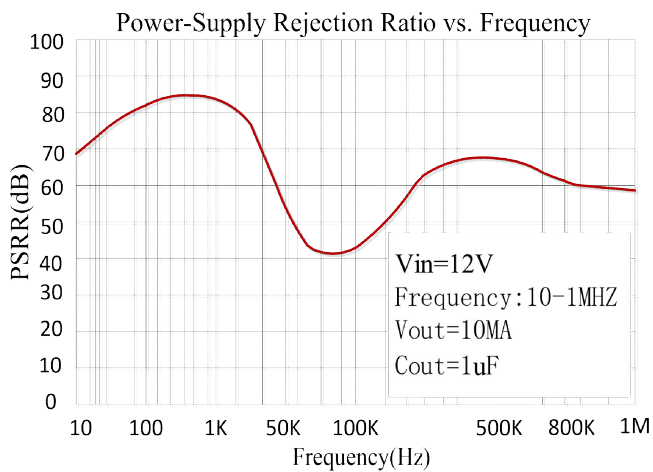
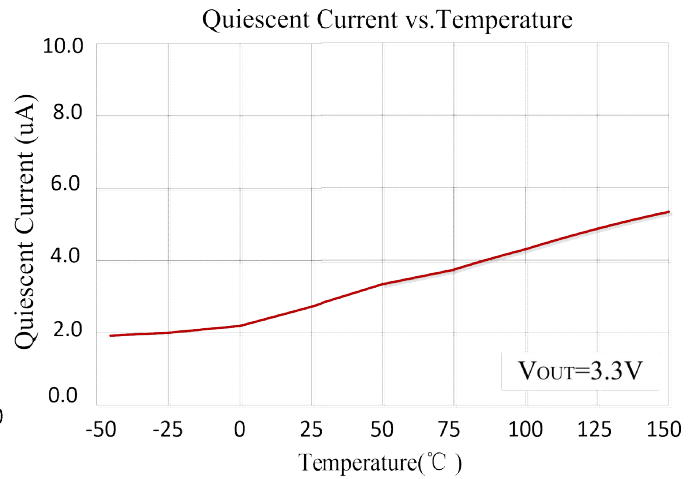
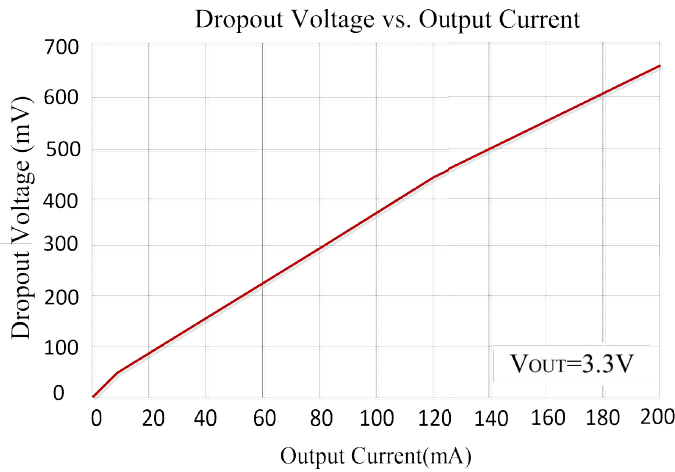
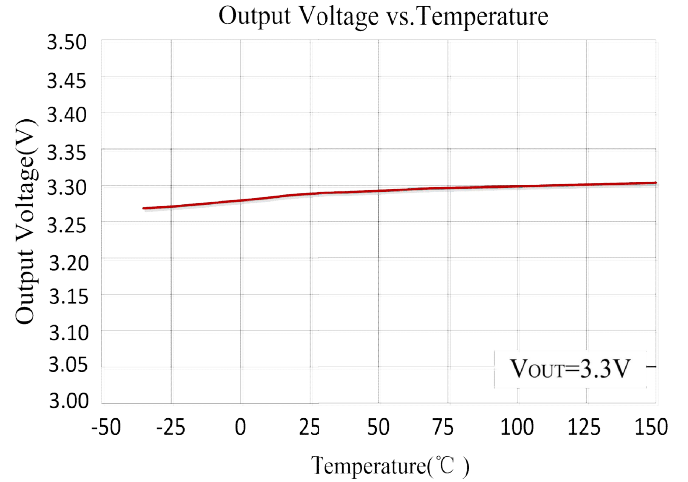
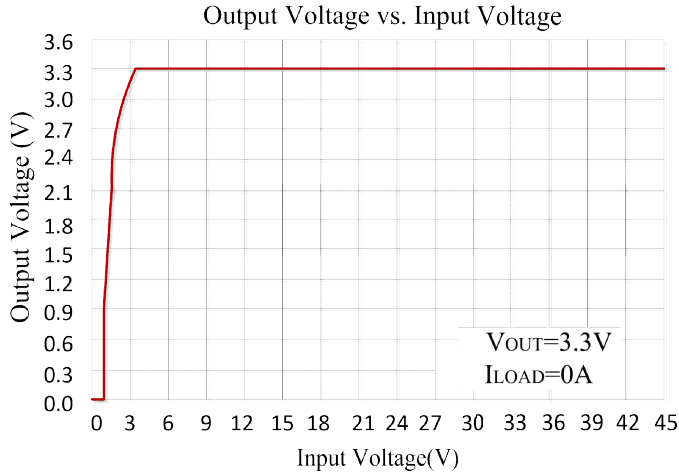

Line Transient Response ($V_{IN}=5$ to $24V$ $V_{OUT}=3.3V$)

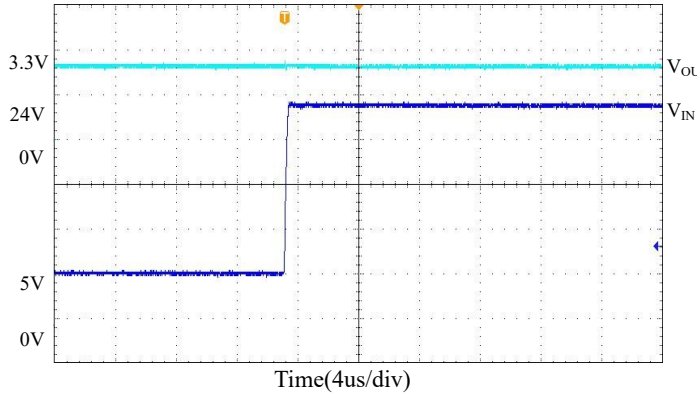

Line Transient Response ($V_{IN}=24$ to $5V$ $V_{OUT}=3.3V$)

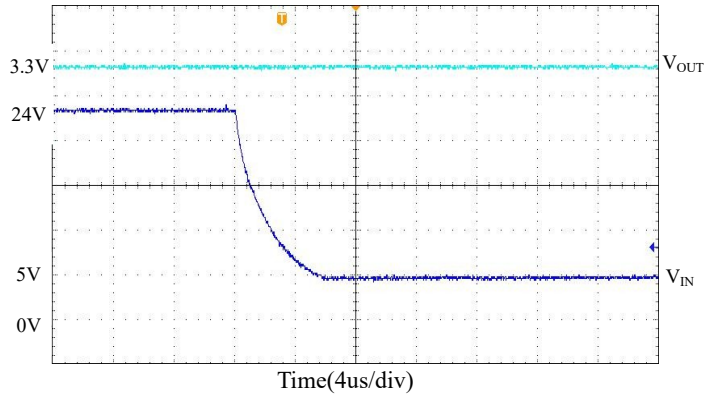

Load Transient Response ($V_{IN}=5V$ $V_{OUT}=0V$ $I_{OUT}=140mA$)

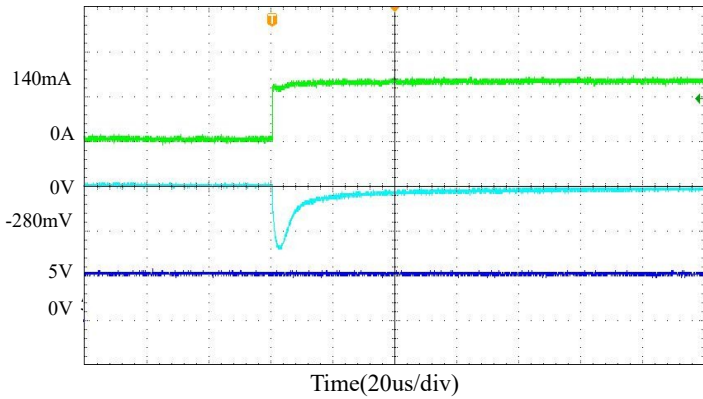

Load Transient Response ($V_{IN}=5V$ $V_{OUT}=0V$ $I_{OUT}=140-0mA$)

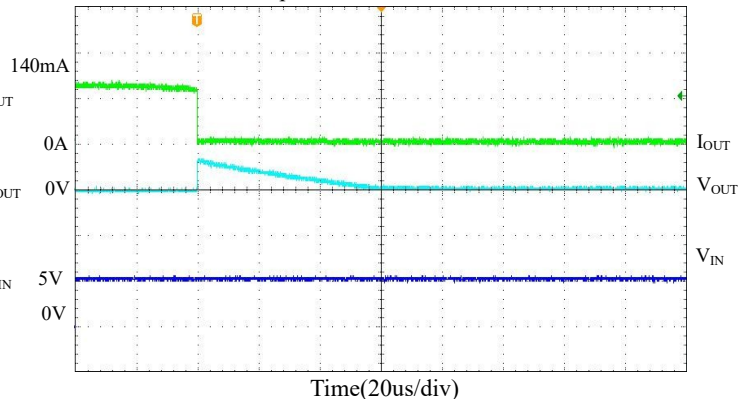

Start Up ($V_{IN}=24V$ $V_{OUT}=3.3V$)

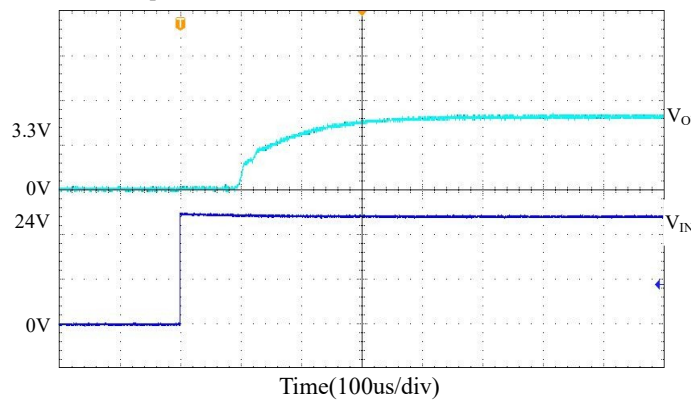

Start Up ($V_{IN}=24V$ $V_{OUT}=3.3V$ $I_{OUT}=150mA$)

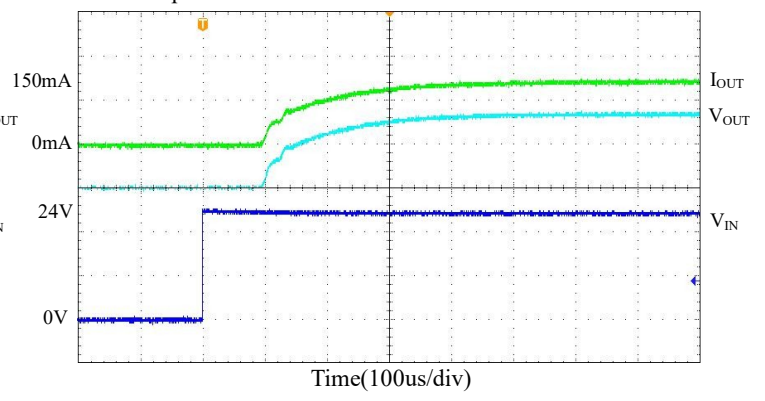

Short Circuit Protection ($V_{IN}=5V$ $V_{OUT}=3.3V$ to short)

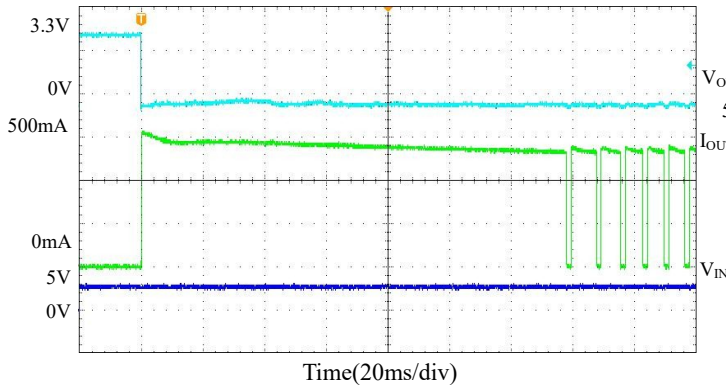

Short Circuit Protection ($V_{IN}=6V$ $V_{OUT}=$ short to $3.3V$)

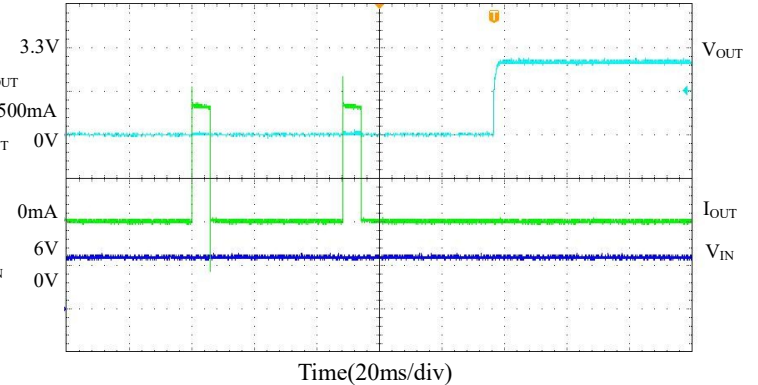

Application Guideline

Input Capacitor

A 10 μ F ceramic capacitor is recommended to connect between V_{DD} and GND pins to decouple input power supply glitch and noise. The amount of the capacitance may be increased without limit. This input capacitor must be located as close as possible to the device to assure input stability and less noise. For PCB layout, a wide copper trace is required for both VIN and GND.

Output Capacitor

An output capacitor is required for the stability of the LDO. The recommended output capacitance is 10 μ F, ceramic capacitor is recommended, and temperature characteristics are X7R or X5R. Higher capacitance values help to improve load/line transient response. The output capacitance may be increased to keep low undershoot/overshoot. Place output capacitor as close as possible to VOUT and GND pins.

Dropout Voltage

The dropout voltage refers to the voltage difference between the VIN and VOUT pins while operating at specific output current. The dropout voltage V_{DROP} also can be expressed as the voltage drop on the pass-FET at specific output current (I_{RATED}) while the pass-FET is fully operating at ohmic region and the pass-FET can be characterized as a resistance R_{DS(ON)}. Thus the dropout voltage can be defined as (V_{DROP} = V_{IN} - V_{OUT} = R_{DS(ON)} × I_{RATED}). For normal operation, the suggested LDO operating range is (V_{IN} > V_{OUT} + V_{DROP}) for good transient response and PSRR ability. Vice versa, while operating at the ohmic region will degrade the performance severely.

Thermal Application

For continuous operation, do not exceed the absolute maximum junction temperature. The maximum power dissipation depends on the thermal resistance of the IC package, PCB layout, rate of surrounding airflow, and difference between junction and ambient temperature. The maximum power dissipation can be calculated as below: TA=25°C, PCB,

The max PD= (125°C - 25°C) / (Thermal Resistance °C/W)

Power dissipation (PD) is equal to the product of the output current and the voltage drop across the output pass element, as shown in the equation below:

$$PD = (V_{IN} - V_{OUT}) \times I_{OUT}$$

Package Information
SOT89-5 Outline Dimensions

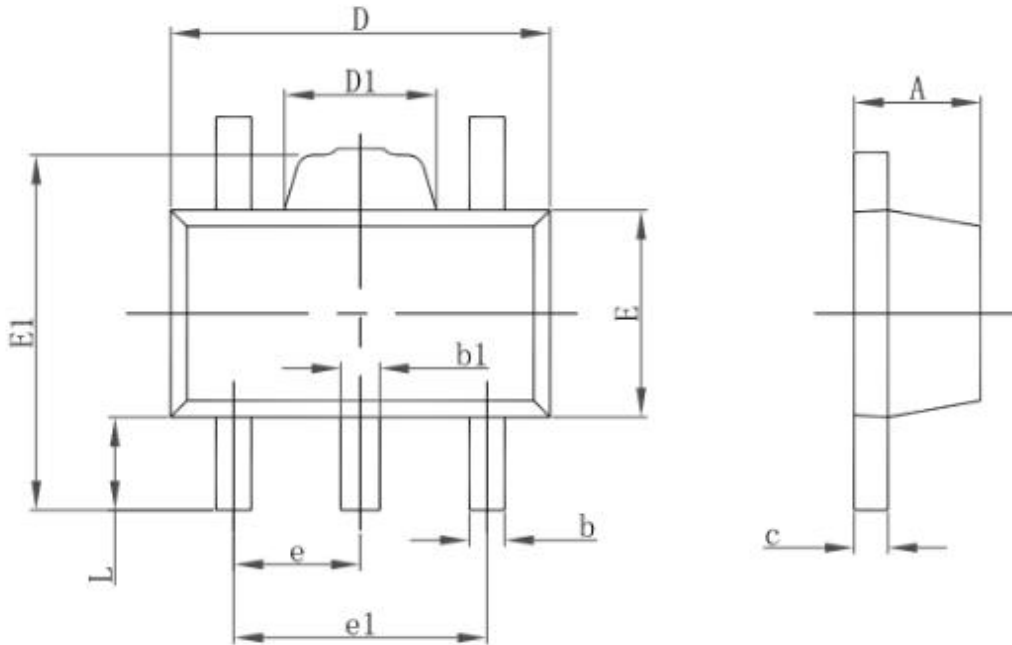

Symbol	Dimensions In Millimeters		Dimensions In Inches	
	Min.	Max.	Min.	Max.
A	1.400	1.600	0.055	0.063
b	0.320	0.520	0.013	0.020
b1	0.360	0.560	0.014	0.022
c	0.350	0.440	0.014	0.017
D	4.400	4.600	0.173	0.181
D1	1.400	1.800	0.055	0.071
E	2.300	2.600	0.091	0.102
E1	3.940	4.250	0.155	0.167
e	1.500TYP.		0.060TYP.	
e1	2.900	3.100	0.114	0.122
L	0.900	1.100	0.035	0.043

SOT23-5 Outline Dimensions

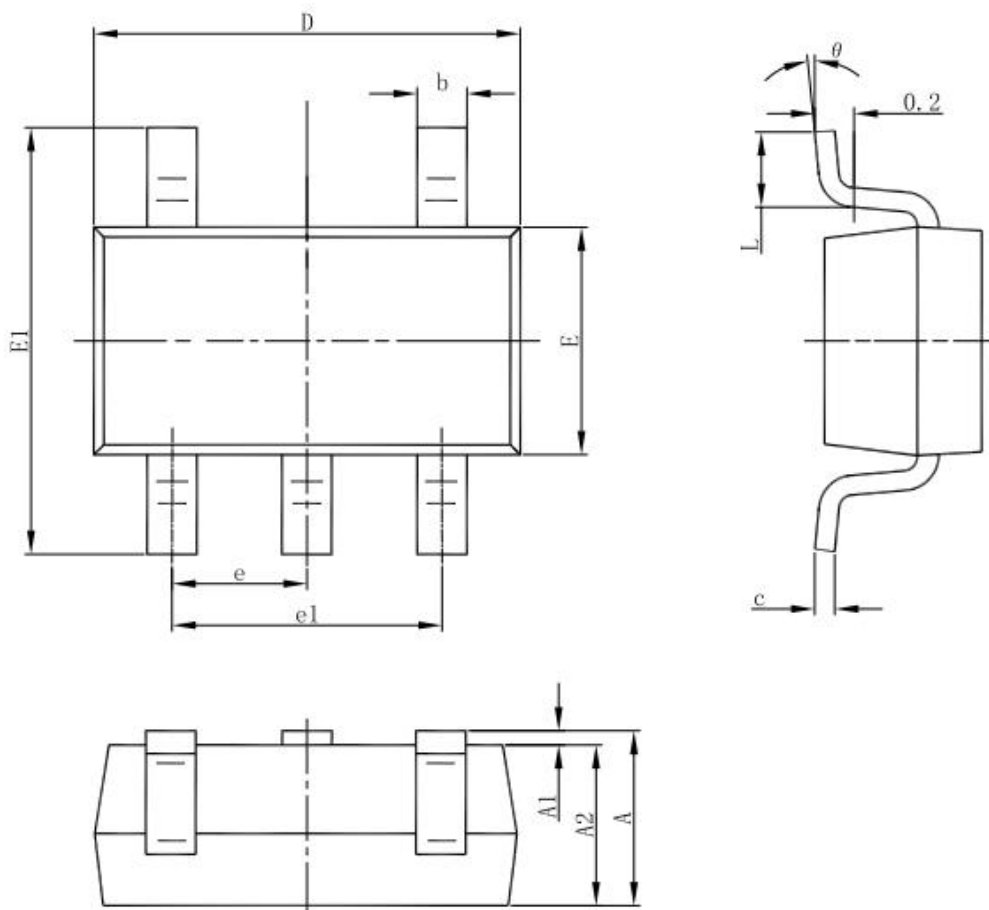

Symbol	Dimensions In Millimeters		Dimensions In Inches	
	Min	Max	Min	Max
A	1.050	1.250	0.041	0.049
A1	0.000	0.100	0.000	0.004
A2	1.050	1.150	0.041	0.045
b	0.300	0.500	0.012	0.020
c	0.100	0.200	0.004	0.008
D	2.820	3.020	0.111	0.119
E	1.500	1.700	0.059	0.067
E1	2.650	2.950	0.104	0.116
e	0.950(BSC)		0.037(BSC)	
e1	1.800	2.000	0.071	0.079
L	0.300	0.600	0.012	0.024
θ	0°	8°	0°	8°

3-pin SOT89 Outline Dimensions

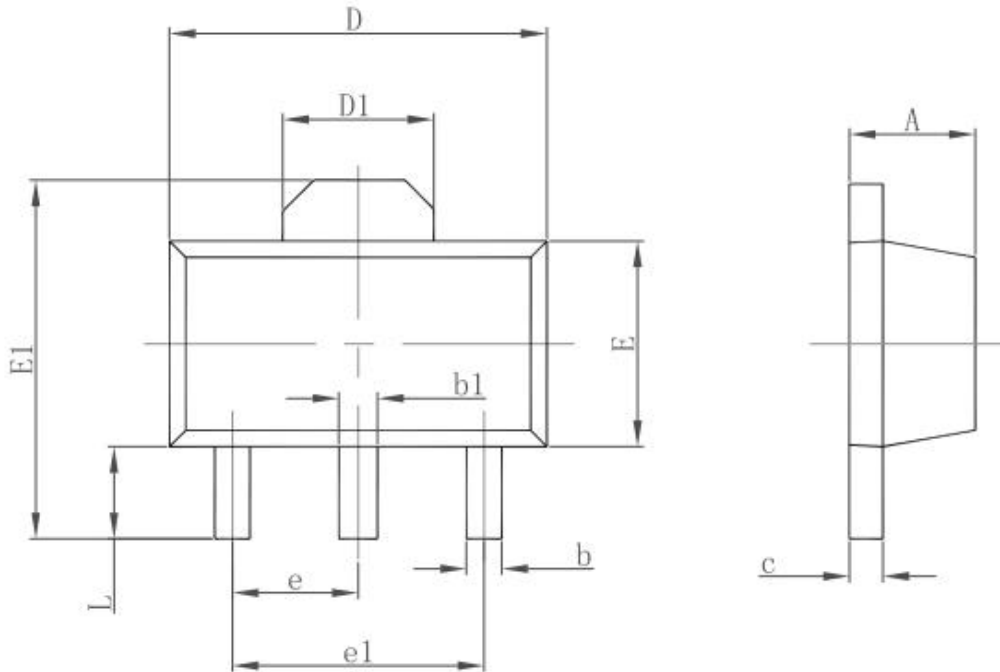

Symbol	Dimensions In Millimeters		Dimensions In Inches	
	Min.	Max.	Min.	Max.
A	1.400	1.600	0.055	0.063
b	0.320	0.520	0.013	0.020
b1	0.400	0.580	0.016	0.023
c	0.350	0.440	0.014	0.017
D	4.400	4.600	0.173	0.181
D1	1.550 REF.		0.061 REF.	
E	2.300	2.600	0.091	0.102
E1	3.940	4.250	0.155	0.167
e	1.500 TYP.		0.060 TYP.	
e1	3.000 TYP.		0.118 TYP.	
L	0.900	1.200	0.035	0.047

X-ON Electronics

Largest Supplier of Electrical and Electronic Components

Click to view similar products for [Linear Voltage Regulators](#) category:

Click to view products by [HEERMICR](#) manufacturer:

Other Similar products are found below :

[LV56831P-E](#) [LV5684PVD-XH](#) [MCDTSA6-2R](#) [L7815ACV-DG](#) [PQ3DZ53U](#) [LV56801P-E](#) [TLE42794G](#) [L78L05CZ/1SX](#) [L78LR05DL-MA-E](#) [636416C](#) [714954EB](#) [BA033LBSG2-TR](#) [LV5680P-E](#) [L78M15CV-DG](#) [L79M05T-E](#) [TLS202A1MBVHTSA1](#) [L78LR05D-MA-E](#) [NCV317MBTG](#) [NTE7227](#) [LV5680NPVC-XH](#) [LT1054CN8](#) [MP2018GZD-5-Z](#) [MP2018GZD-33-Z](#) [MIC5281-3.3YMM](#) [MC78L06BP-AP](#) [TA48LS05F\(TE85L,F\)](#) [TA78L12F\(TE12L,F\)](#) [TC47BR5003ECT](#) [TCR2LN12,LF\(S](#) [TCR2LN28,LF\(S](#) [TCR2LN30,LF\(S](#) [TCR3DF295,LM\(CT](#) [TCR3DF40,LM\(CT](#) [BA178M20CP-E2](#) [L78M12ABDT](#) [LM7812SX/NOPB](#) [LR645N3-G-P003](#) [LR645N3-G-P013](#) [ZXTR2005P5-13](#) [SCD7812BTG](#) [TCR3DF335,LM\(CT](#) [ZXTR2012K-13](#) [TLE42994E V33](#) [ZXTR2008K-13](#) [ZXTR2005K-13](#) [L88R05DL-E](#) [ADP3300ARTZ-2.7RL7](#) [LM120K-15/883](#) [IFX54441LDVXUMA1](#) [LM317D2T-TR](#)