

Features

- Low power consumption
- Low Quiescent Current: 5uA at 6V
- Low voltage drop
- Output voltage accuracy: tolerance $\pm 2\%$
- Low temperature coefficient

Applications

- Battery-powered equipment
- Portable AV systems
- Reference voltage sources
- Mobile phones
- Cameras, video cameras
- Portable games

General Description

HE6206 series are a highly precise, lower consumption, 3 terminal, positive voltage regulators manufactured using CMOS and laser trimming technologies. The series provides large currents with a significantly small dropout voltage .

The HE6206 consists of a current limiter circuit, a driver transistor, a precision reference voltage and an error correction circuit. The series is compatible with low ESR ceramic capacitors. The

current limiter's foldback circuit operates as a short circuit protection as well as the output current limiter for the output pin. Output voltages are internally by laser trimming technologies. It is selectable in 0.1V increments within a range of 1.2V to 5.0V. HE6206 series are available in SOT-23 、 SOT23-3and SOT-89 packages.

Typical Application

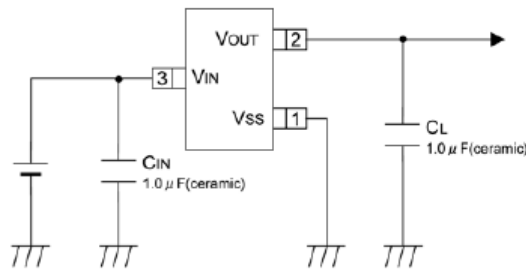

Order Information

HE6206- ①②③④

Environmental Standard:
R:RoHs/Pb Free
G: Halogen Free

Package:
N:SOT23
M:SOT23-3
P:SOT89

Output Voltage:
15~50: e.g. 15=1.5V 30=3.0V
33=3.3V 50=5.0V

Block Diagram

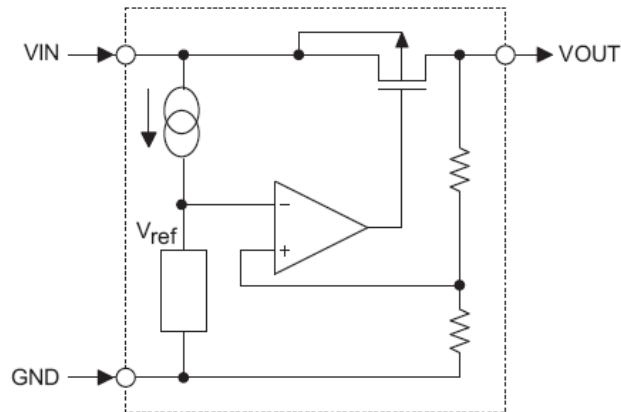

Pin Assignment

SOT23-3 and SOT23
(Top view)

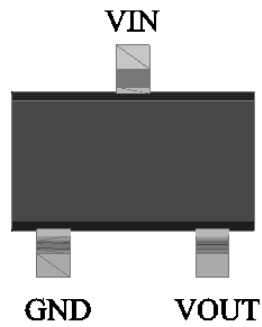

SOT89 (Top view)

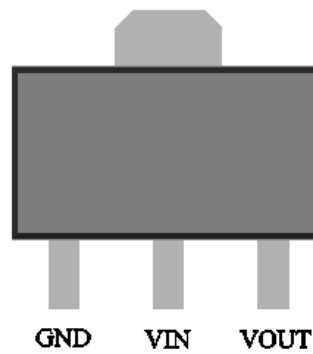

Marking Rule

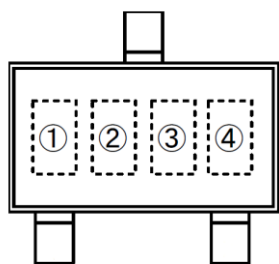

SOT-23
(TOP VIEW)

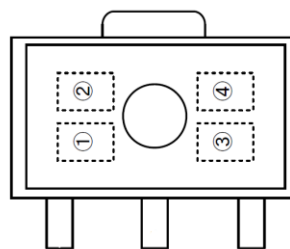

SOT-89
(TOP VIEW)

① represents product number

MARK	PRODUCT SERIES
6	HE6206****

② represents 3 pins regulator

MARK		PRODUCT SERIES
VOLTAGE=0.1~3.0V	VOLTAGE=3.1V~6.0V	
5	6	HE6206

③ represents output voltage

MARK	VOLTAGE(V)			MARK	VOLTAGE(V)		
0	-	3.1	-	F	1.6	4.6	-
1	-	3.2	-	H	1.7	4.7	-
2	-	3.3	-	K	1.8	4.8	-
3	-	3.4	-	L	1.9	4.9	-
4	-	3.5	-	M	2.0	5.0	-
5	-	3.6	-	N	2.1	-	-
6	-	3.7	-	P	2.2	-	-
7	-	3.8	-	R	2.3	-	-
8	-	3.9	-	S	2.4	-	-
9	-	4.0	-	T	2.5	-	-
A	-	4.1	-	U	2.6	-	-
B	1.2	4.2	-	V	2.7	-	-
C	1.3	4.3	-	X	2.8	-	-
D	1.4	4.4	-	Y	2.9	-	-
E	1.5	4.5	-	Z	3.0	-	-

④ X

Absolute Maximum Ratings

Parameter		Symbol	Ratings	Units
Input Voltage		V_{IN}	8	V
Output Current		I_{OUT}	300*	mA
Output Voltage		V_{OUT}	$V_{SS}-0.3\sim V_{IN}+0.3$	V
Power Dissipation	SOT-23	P_d	0.20	W
	SOT-89		0.50	W
	USP-6B		0.10	W
	TO-92		0.30	W
Operating Temperature Range		T_{opr}	-40~+85	°C
Storage Temperature Range		T_{stg}	-55~+125	°C

* $I_{OUT}=P_d/(V_{IN}-V_{OUT})$

Electrical Characteristics

HE6206 for any output voltage

($T_a=25^\circ\text{C}$)

Parameter	Symbol	Conditions	Min.	Typ.	Max.	Unit
Output Voltage	V_{out}	$V_{in}=V_{out}+1V$ $1.0mA\leq I_{out}\leq 30mA$	$V_{out}\times 0.98$	--	$V_{out}\times 1.02$	V
Output Current*1	I_{out}	$V_{in}-V_{out}=1V$	--	300	--	mA
Low dropout*2	V_{drop}	Refer to the next table				
Line Regulation	$\Delta V_{out1}/(V_{in}-V_{out})$	$1.6V\leq V_{in}\leq 8V$ $I_{out}=40mA$	--	0.05	0.2	%/V
Load Regulation	$\Delta V_{out} / \Delta I_{out}$	$V_{in}=V_{out}+1V$ $1.0mA\leq I_{out}\leq 80mA$	--	12	30	mV
Output voltage Temperature Coefficiency	$\Delta V_{out}/(T_a\cdot V_{out})$	$I_{out}=30mA$ $0^\circ\text{C}\leq T_a\leq 70^\circ\text{C}$	--	± 100	--	Ppm/°C
Supply Current	I_{ss1}	--	--	5	6	μA
	I_{ss2}	SOT23-5(Pull down resistor inside)	--	8	10	μA
Input Voltage	V_{in}	--	--	--	8	V
PSRR	PSRR	$F=1KHz$ $V_{in}=V_{out}+1V$	--	50	--	dB
Output Noise	EN	$BW=10Hz\sim 100KHz$	--	30	--	μV_{rms}

Electrical Characteristics by Output Voltage:

Output Voltage Vout(V)	Dropout Voltage Vdif (V)		
	Conditions	Typ.	Max.
Vout≤1.5V	Iout=100 mA	0.35	0.57
1.8 ≤ Vout ≤ 2		0.28	0.42
2.8 ≤ Vout ≤ 5.0		0.19	0.35

Typical Performance Characteristics

(1) Output Voltage vs Input voltage and Output Voltage vs. Output Current and Input Transient Response

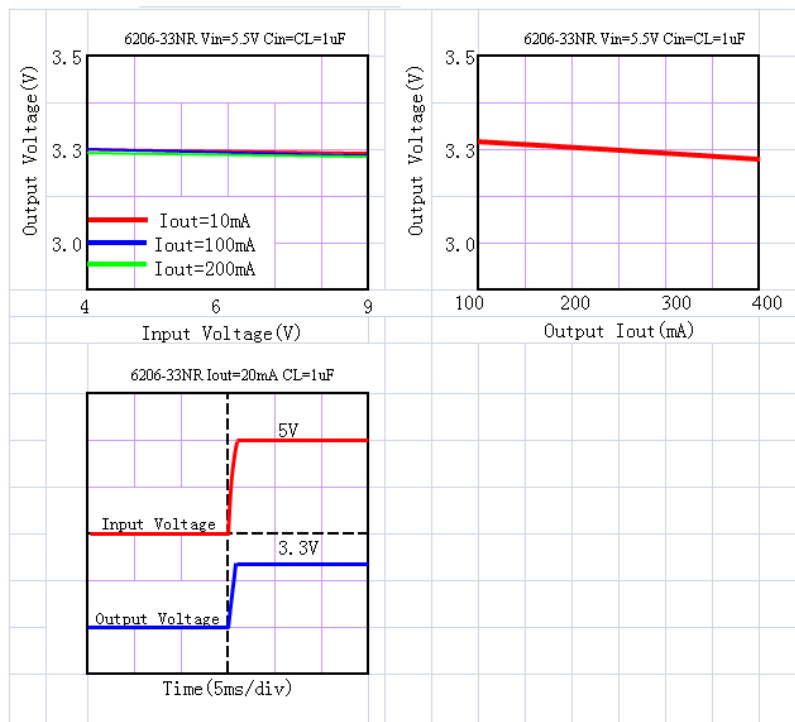

(2) Output Voltage vs. Ambient Temperature

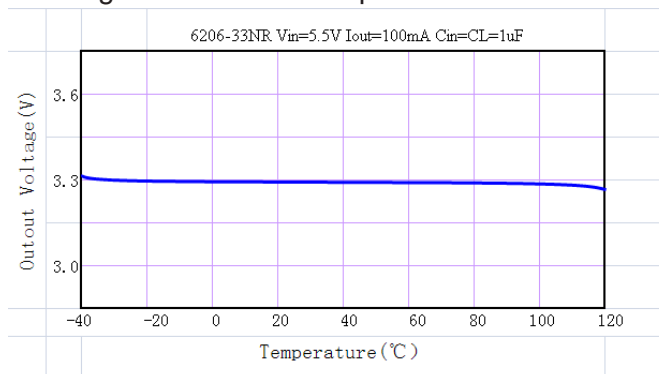

Package Information
3-pin SOT23 Outline Dimensions

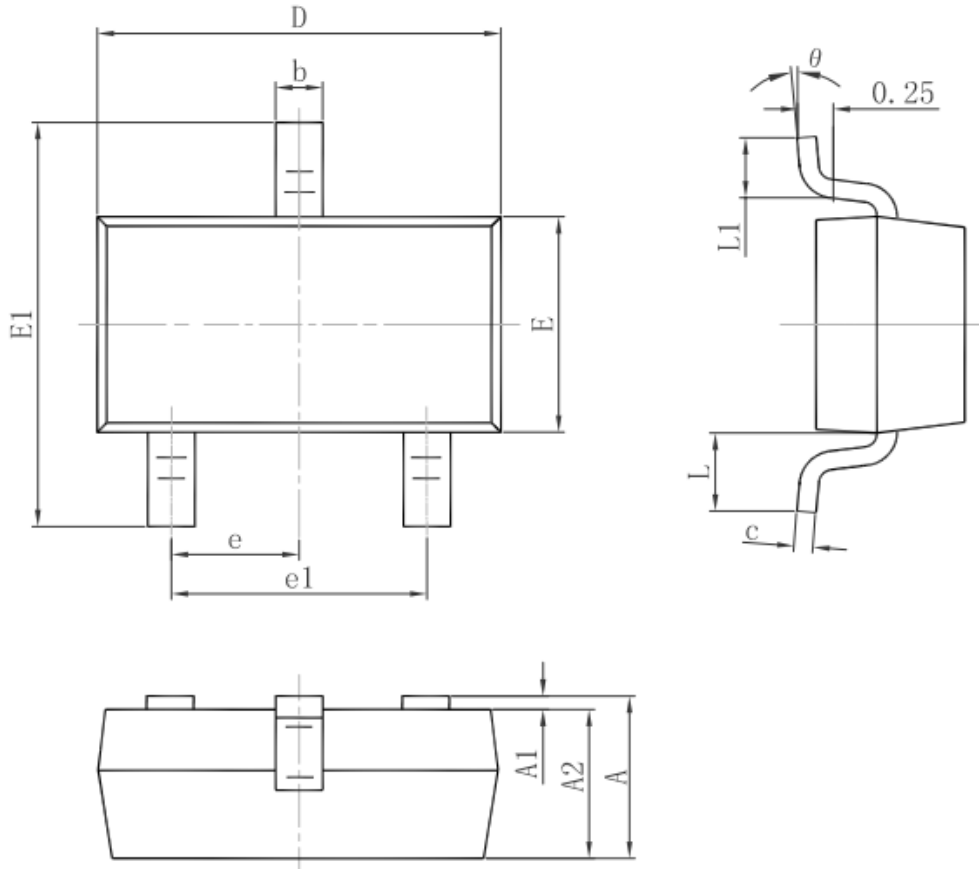

Symbol	Dimensions In Millimeters		Dimensions In Inches	
	Min.	Max.	Min.	Max.
A	0.900	1.150	0.035	0.045
A1	0.000	0.100	0.000	0.004
A2	0.900	1.050	0.035	0.041
b	0.300	0.500	0.012	0.020
c	0.080	0.150	0.003	0.006
D	2.800	3.000	0.110	0.118
E	1.200	1.400	0.047	0.055
E1	2.250	2.550	0.089	0.100
e	0.950 TYP.		0.037 TYP.	
e1	1.800	2.000	0.071	0.079
L	0.550 REF.		0.022 REF.	
L1	0.300	0.500	0.012	0.020
θ	0°	8°	0°	8°

3-pin SOT23-3 Outline Dimensions

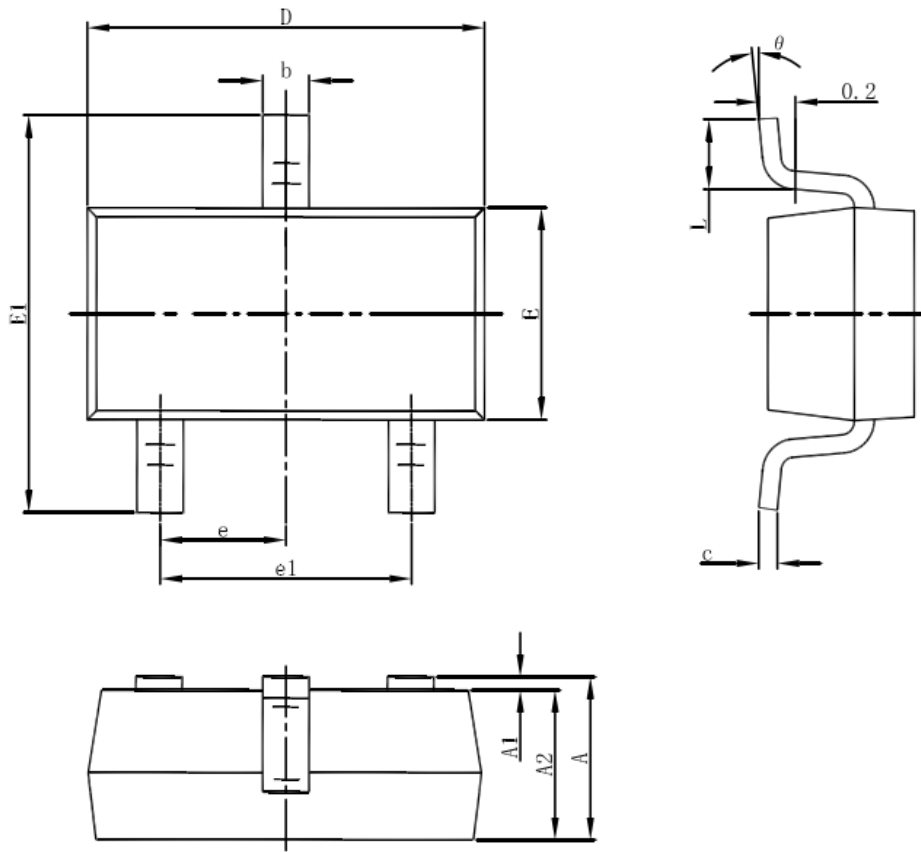

Symbol	Dimensions In Millimeters		Dimensions In Inches	
	Min	Max	Min	Max
A	1.050	1.250	0.041	0.049
A1	0.000	0.100	0.000	0.004
A2	1.050	1.150	0.041	0.045
b	0.300	0.500	0.012	0.020
c	0.100	0.200	0.004	0.008
D	2.820	3.020	0.111	0.119
E	1.500	1.700	0.059	0.067
E1	2.650	2.950	0.104	0.116
e	0.950(BSC)		0.037(BSC)	
e1	1.800	2.000	0.071	0.079
L	0.300	0.600	0.012	0.024
θ	0°	8°	0°	8°

3-pin SOT89 Outline Dimensions

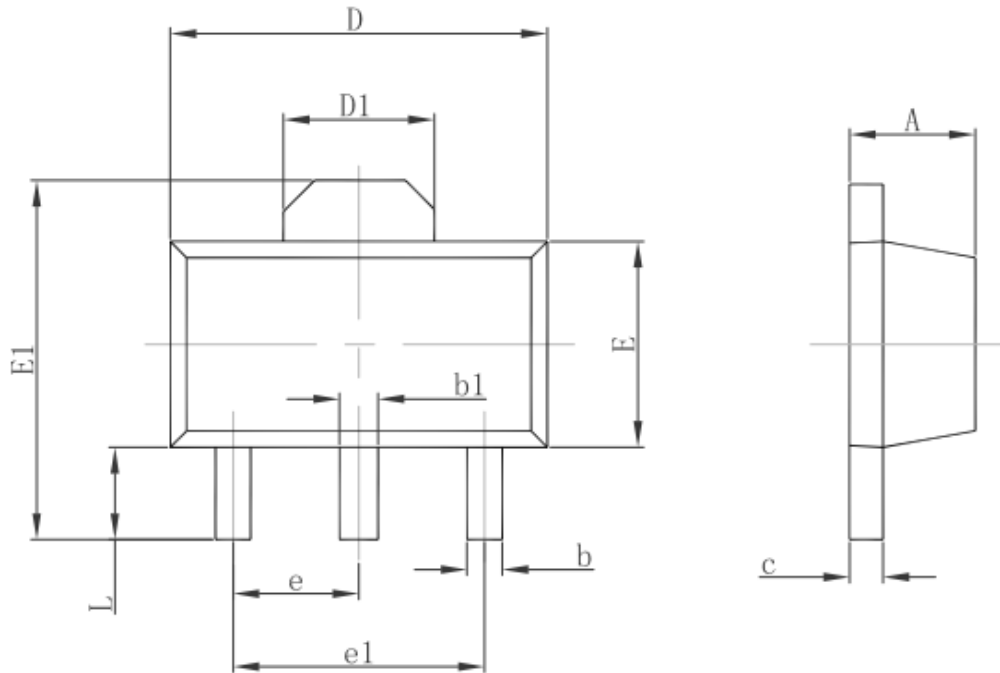

Symbol	Dimensions In Millimeters		Dimensions In Inches	
	Min.	Max.	Min.	Max.
A	1.400	1.600	0.055	0.063
b	0.320	0.520	0.013	0.020
b1	0.400	0.580	0.016	0.023
c	0.350	0.440	0.014	0.017
D	4.400	4.600	0.173	0.181
D1	1.550 REF.		0.061 REF.	
E	2.300	2.600	0.091	0.102
E1	3.940	4.250	0.155	0.167
e	1.500 TYP.		0.060 TYP.	
e1	3.000 TYP.		0.118 TYP.	
L	0.900	1.200	0.035	0.047

X-ON Electronics

Largest Supplier of Electrical and Electronic Components

Click to view similar products for [Linear Voltage Regulators](#) category:

Click to view products by [HEERMICR](#) manufacturer:

Other Similar products are found below :

[LV56831P-E](#) [LV5684PVD-XH](#) [MCDTSA6-2R](#) [L7815ACV-DG](#) [PQ3DZ53U](#) [LV56801P-E](#) [L78L05CZ/1SX](#) [L78LR05DL-MA-E](#) [636416C](#)
[714954EB](#) [LV5680P-E](#) [L78M15CV-DG](#) [L79M05T-E](#) [MIC5283-5.0YML-T5](#) [TLS202A1MBVHTSA1](#) [L78LR05D-MA-E](#) [NCV317MBTG](#)
[NTE7227](#) [MP2018GZD-33-P](#) [MP2018GZD-5-P](#) [LV5680NPVC-XH](#) [LT1054CN8](#) [MP2018GZD-5-Z](#) [MP2018GZD-33-Z](#) [AT55EL50ESE](#)
[APL5934DKAI-TRG](#) [CL9193A15L5M](#) [CL9036A30F4M](#) [CL9036A18F4M](#) [CL9036A25F4M](#) [CL9036A28F4M](#) [CL9036A33F4M](#)
[CL9906A18F4N](#) [CL9906A30F4N](#) [CL9908A30F4M](#) [CL9908A33F4M](#) [CL9908A18F4M](#) [CL9908A28F4M](#) [TL431ACM/TR](#) [TL431AIM/TR](#)
[LM78L05ACM/TR](#) [HT7812ARMZ](#) [HT7805ARMZ](#) [HXY6206I-3.0](#) [HXY6206I-3.3](#) [XC6206P252MR](#) [XC6206P282MR](#) [XC6206P302MR](#)
[XC6206P332MR](#) [CJ6211B12F](#)