

Features

- Low power consumption:0.3uA (Typ.)
- Low voltage drop:
100mV@100mA@VOU=3.3V(Typ.)
- High Output Current: ≥500mA
- Low temperature coefficient
- Integrated Short-Circuit Protection
- Over-Temperature Protection
- High input voltage (up to 7V)
- Output voltage accuracy: tolerance ±1%
- Build-in Enable/Output Current Limit circuit
- SOT23-5、SOT23-3、SOT89-3L、DFN1x1-4L package
- PSRR=70dB@1KHz
- Support Fixed Output Voltage :
1.0v/1.2v/1.5v/1.8v/2.5v/2.8v/3.0v/3.3v

Applications

- Battery-powered equipment
- Communication equipment
- Mobile phones
- Portable games
- Cameras, Video cameras
- Reference voltage sources

General Description

The HE9073 series are highly accurate, low noise, CMOS LDO Voltage Regulators. Offering low output noise, high ripple rejection ratio, low dropout and very fast turn-on times, the HE9073 series is ideal for today's cutting edge mobile phone. Internally the HE9073 includes a reference voltage source, error amplifiers, driver transistors, current limiters and phase compensators.

The output voltage is set by current trimming. Voltages are selectable in 100mV steps within a range of 1.2V to 5.0V.

The HE9073 series is also fully compatible with

low ESR ceramic capacitors, reducing cost and improving output stability. This high level of output stability is maintained even during frequent load fluctuations, due to the excellent transient response performance and high PSRR achieved across a broad range of frequencies. The CE function allows the output of regulator to be turned off, resulting in greatly reduced power consumption.

Order Information

HE9073①②③④⑤

Designator	Symbol	Description
①	A	Standard
②③	Integer	Output Voltage(1.2~5.0V)
④	D4	Package:DFN1x1-4L
	P	Package:SOT89
	M	Package:SOT23-3
	M5	Package:SOT23-5
⑤	R	RoHS / Pb Free
	G	Halogen Free

Note:"②③" stands for output voltages. Other voltages can be specially customized

Package and Pin assignment

SOT23-5 (Top View)

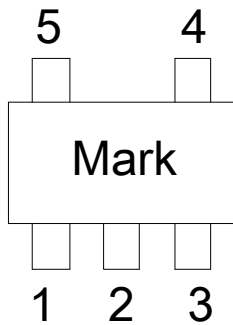

Table1: HE9073AXXM5R series (SOT23-5 PKG)

PIN NUMBER	SYMBOL	FUNCTION
1	V_{IN}	Power Input Pin
2	GND	Ground
3	CE	Chip Enable Pin
4	NC	No Connection
5	V_{OUT}	Output Pin

SOT23-3 (Top View)

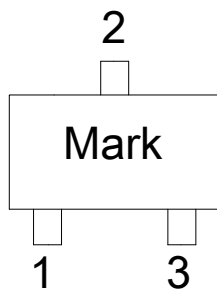

Table2: HE9073AXXMR series (SOT23-3 PKG)

PIN NUMBER	SYMBOL	FUNCTION
1	GND	Ground
2	V_{IN}	Power Input Pin
3	V_{OUT}	Output Pin

SOT89-3 (Top View)

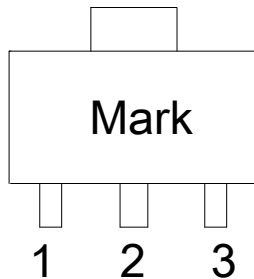

Table3 HE9073AXXPR series (SOT89-3 PKG)

PIN NO.	PIN NAME	FUNCTION
1	GND	GND pin
2	VIN	Input voltage pin
3	VOUT	Output voltage pin

DFN1x1-4L (Top View)

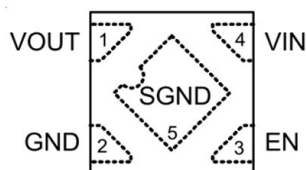

Table4 HE9073AXXD4R series (DFN1*1-4LPKG)

PIN NUMBER	SYMBOL	FUNCTION
1	V_{OUT}	Output Pin
2	GND	Ground
3	CE	Chip Enable Pin
4	V_{IN}	Power Input Pin
5	SGND	Substrate of Chip. Leave floating or tie to GND

Marking Rule

MARKING	
VOLTAGE(V)	Package
	SOT23-3、SOT89-3
1.2	AJ12C
1.5	AJ15C
1.8	AJ18C
2.5	AJ25C
2.8	AJ28C
3.0	AJ30C
3.3	AJ33C

MARKING	
VOLTAGE(V)	Package
	SOT23-5、DFN1x1-4L
1.2	AJ=SA
1.5	AJ=SE
1.8	AJ=SH
2.5	AJ=2E
2.8	AJ=2H
3.0	AJ=3B
3.3	AJ=3C

Absolute Maximum Ratings

Supply Voltage-0.3V to 9V

Storage Temperature-50°C to 125°C

Operating Temperature-40°C to 85°C

Note: These are stress ratings only. Stresses exceeding the range specified under “Absolute Maximum Ratings” may cause substantial damage to the device. Functional operation of this device at other conditions beyond those listed in the specification is not implied and prolonged exposure to extreme conditions may affect device reliability.

Thermal Information

Symbol	Parameter	Package	Max.	Unit
θ_{JA}	Thermal Resistance (Junction to Ambient) (Assume no ambient airflow, no heat sink)	SOT23-3	500	°C/W
		SOT23-5	500	°C/W
		SOT89-3	200	°C/W
P_D	Power Dissipation	SOT23-3	0.20	W
		SOT23-5	0.20	W
		SOT89-3	0.50	W

Note: P_D is measured at $T_a = 25^\circ\text{C}$

Electrical Characteristics

HE9073 series

(Ta=25°C)

Parameter	Symbol	Conditions	Min.	Typ.	Max.	Unit
Output Voltage	Vout	Vin=Vout+1V 1.0mA≤Iout≤30mA	Vout×0.99	--	Vout×1.01	V
Output Current*1	Iout	Vin-Vout=1V	--	500	600	mA
Line Regulation	$\frac{\Delta V_{out}}{\Delta V_{in}}$	4.3V≤Vin≤7V Iout=10mA	--	0.05	0.2	%/V
Load Regulation	ΔV_{out}	Vin= 4.3V 1.0mA≤Iout≤100mA	--	10	30	mV
Output voltage Temperature Coefficiency	$\frac{\Delta V_{out}}{Ta \cdot V_{out}}$	Iout=30mA 0°C≤Ta≤70°C	--	±100	--	Ppm/°C
Supply Current	Iss1	--	0.2	0.3	0.5	uA
Input Voltage	Vin	--	--	--	7	V
PSRR	PSRR	F=1KHz, Vin=4.3Vdc+1Vpp	--	70	--	dB

Typical Application Circuit

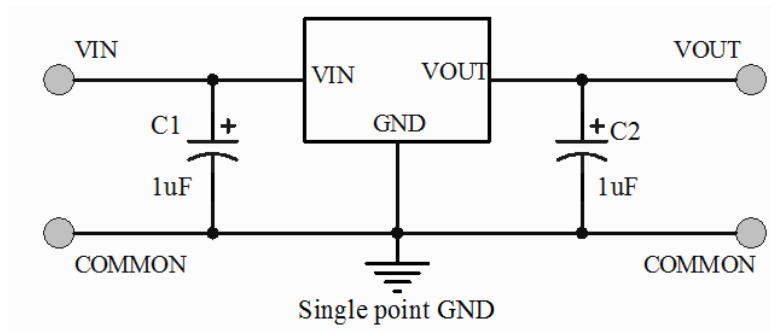
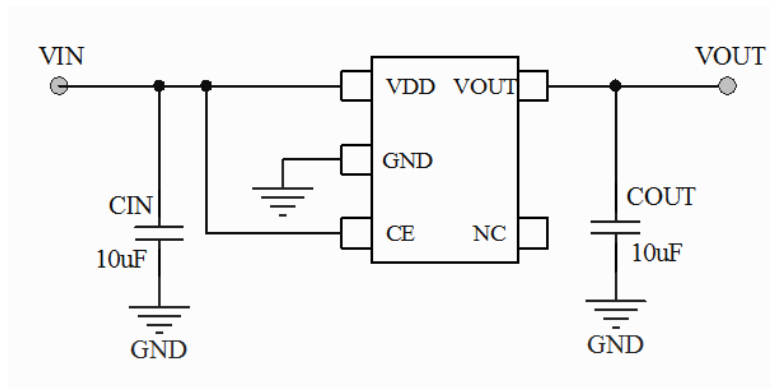

Typical Performance Characteristics

Test Condition: $T_A=25^\circ\text{C}$, unless otherwise note

1、VOUT vs TEMP

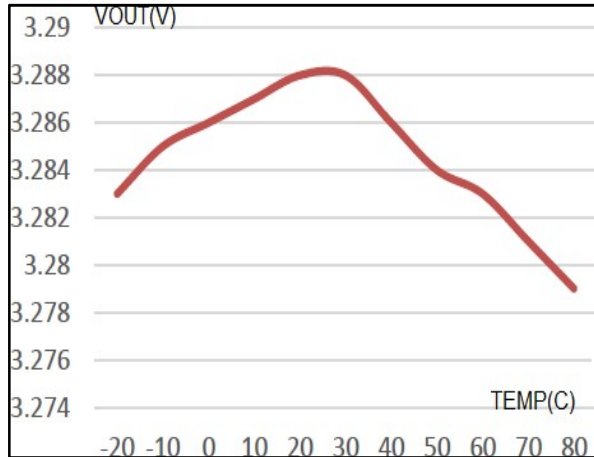

2、IQ vs VIN ⁽¹⁾

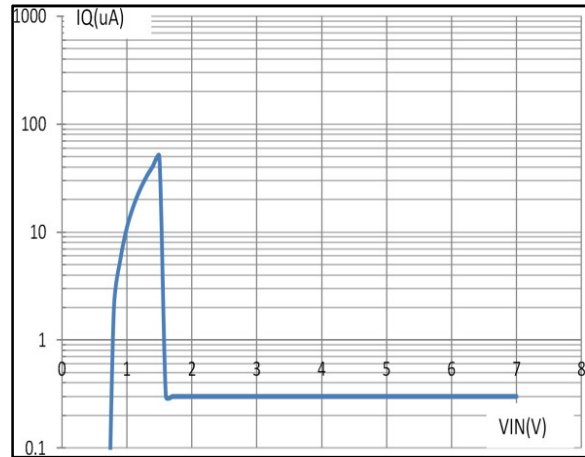

3、Load Regulation

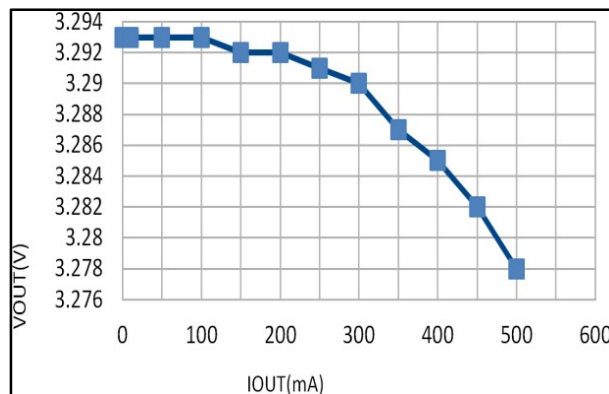

4、Line Regulation

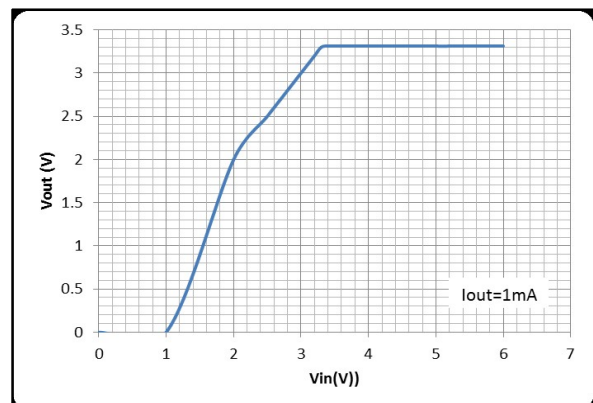

5、Dropout Voltage vs Load Current

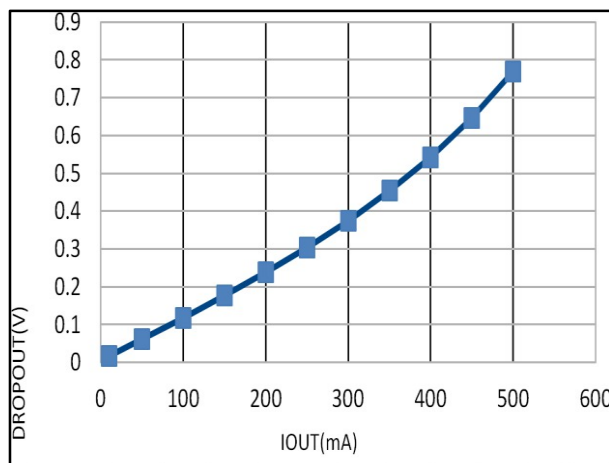

6、PSRR

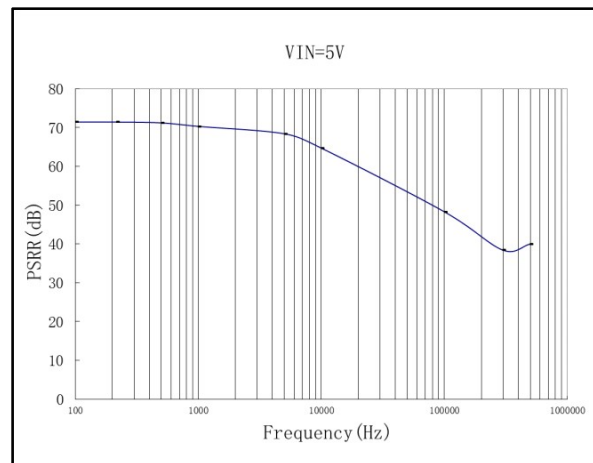

7、Load Transient Response

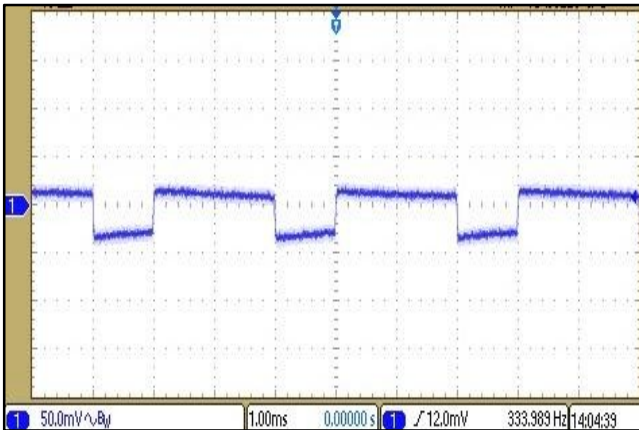

8、Short Output & Over-Current Response

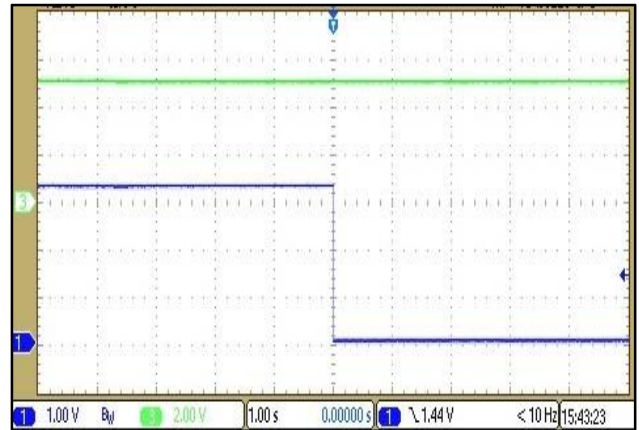

9、Power-On

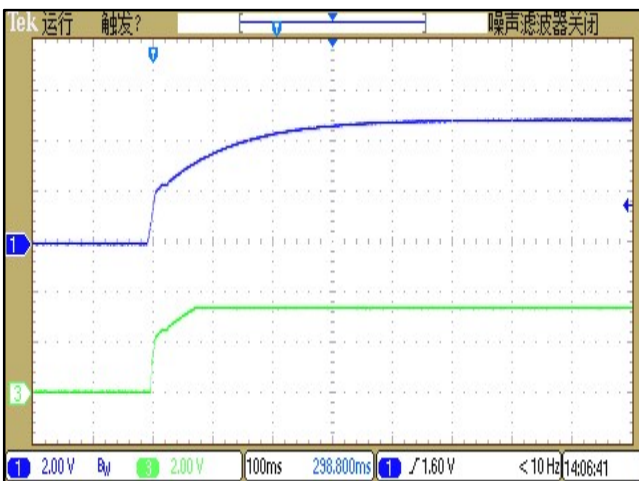

10、Power-Off

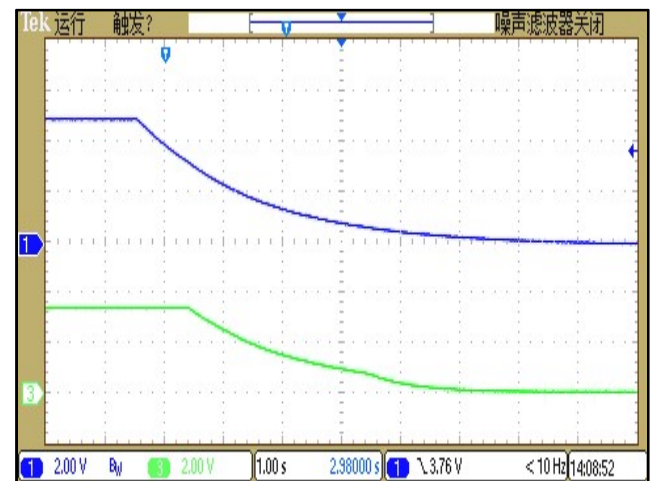

11、Enable

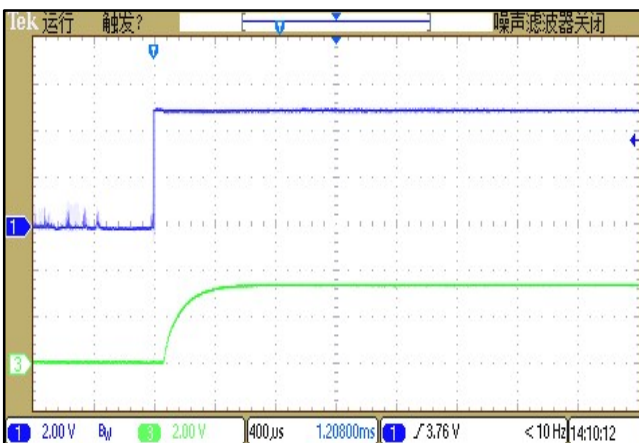

12、Disable

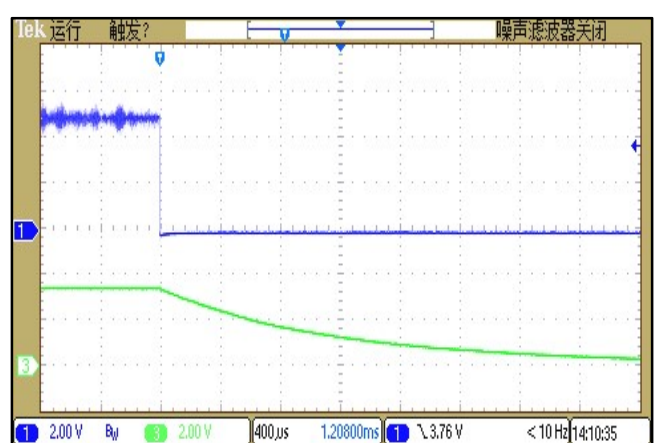

Note: (1)

Operational Explanation

<Output Voltage Control>

The P-channel MOSFET is connected to the V_{OUT} pin, driven by the subsequent output signal. The output voltage at the V_{OUT} pin is controlled and stabilized by a system of negative feedback. The IC's internal circuitry can shut-down by the CE pin's signal

<Low ESR Capacitors>

With the HE9073 series, a stable output voltage is achievable even if used with low ESR capacitors as a phase compensation circuit is built-in. In order to ensure the effectiveness of the phase compensation, we suggest that an output capacitor (C_L) is connected as close as possible to the output pin (V_{OUT}) and the GND pin. Please use an output capacitor with a capacitance value of at least 10uF. Also, please connect an input capacitor (C_{IN}) of 10uF between the V_{IN} pin and the GND pin in order to ensure a stable power input. Stable phase compensation may not be ensured if the capacitor runs out capacitance when depending on bias and temperature. In case the capacitor depends on the bias and temperature, please make sure the capacitor can ensure the actual capacitance.

<CE Pin>

The IC's internal circuitry can be shutdown via the signal from the CE pin with the HE9073 series. The operational logic of the IC's CE pin is selectable (please refer to the selection guide). Although the CE pin is equal to an inverter input with CMOS hysteresis, with either the pull-up or pull-down options, the CE pin input current will increase when the IC is in operation. We suggest that you use this IC with either a V_{IN} voltage or a V_{SS} voltage input at the CE pin. If this IC is used with the correct specifications for the CE pin, the operational logic is fixed and the IC will operate normally. However, supply current may increase as a result of through current in the IC's internal circuitry.

Notes on Use

1. Please use this IC within the stated absolute maximum ratings. The IC is liable to malfunction should the ratings be exceeded.
2. Where wiring impedance is high, operations may become unstable due to noise and/or phase lag depending on output current. Please keep the resistance low between V_{IN} and V_{SS} wiring in particular.
3. Please wire the input capacitor (C_{IN}) and the output capacitor (C_L) as close to the IC as possible.

Packaging Information

SOT23-5 Outline Dimensions

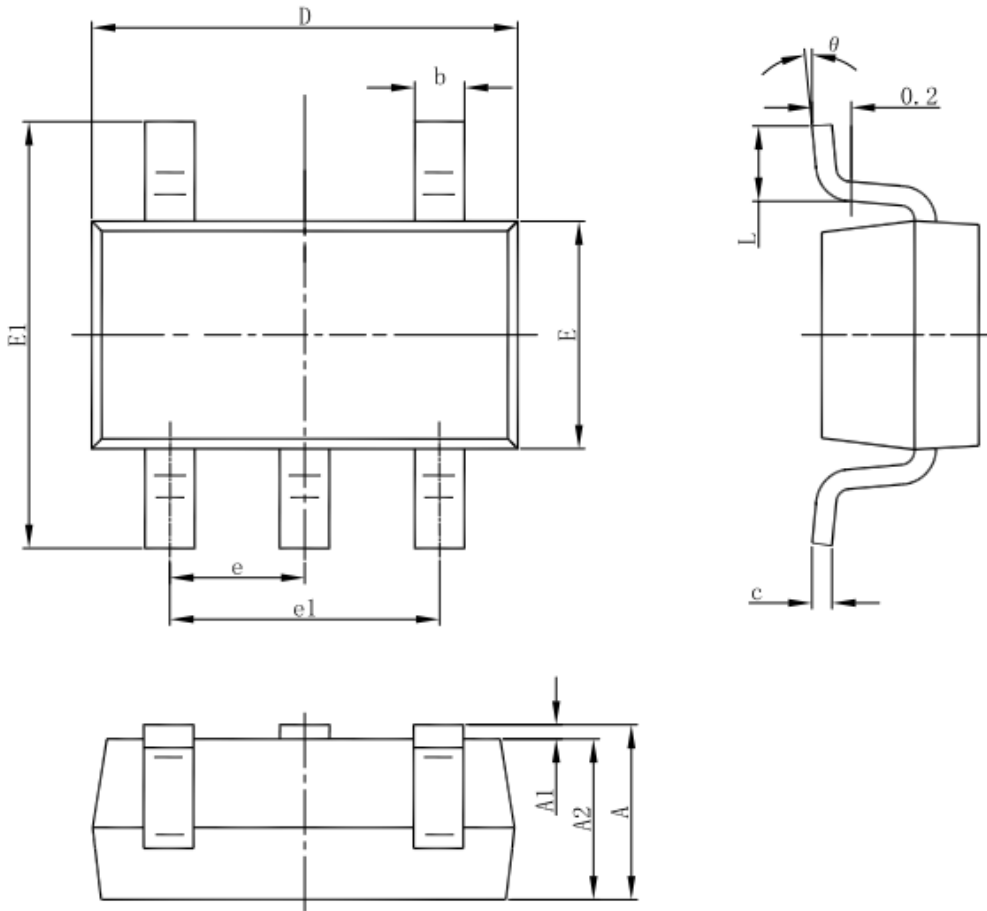

Symbol	Dimensions In Millimeters		Dimensions In Inches	
	Min	Max	Min	Max
A	1.050	1.250	0.041	0.049
A1	0.000	0.100	0.000	0.004
A2	1.050	1.150	0.041	0.045
b	0.300	0.500	0.012	0.020
c	0.100	0.200	0.004	0.008
D	2.820	3.020	0.111	0.119
E	1.500	1.700	0.059	0.067
E1	2.650	2.950	0.104	0.116
e	0.950(BSC)		0.037(BSC)	
e1	1.800	2.000	0.071	0.079
L	0.300	0.600	0.012	0.024
θ	0°	8°	0°	8°

3-pin SOT23-3 Outline Dimensions

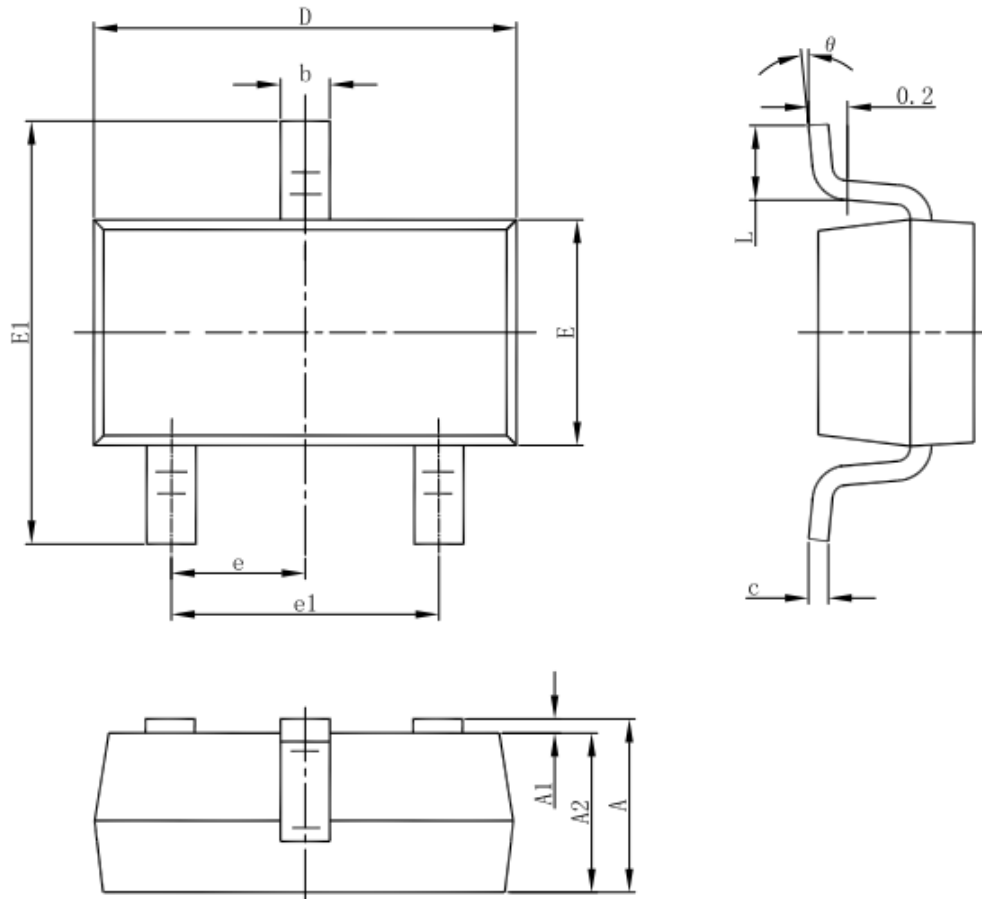

Symbol	Dimensions In Millimeters		Dimensions In Inches	
	Min	Max	Min	Max
A	1.050	1.250	0.041	0.049
A1	0.000	0.100	0.000	0.004
A2	1.050	1.150	0.041	0.045
b	0.300	0.500	0.012	0.020
c	0.100	0.200	0.004	0.008
D	2.820	3.020	0.111	0.119
E	1.500	1.700	0.059	0.067
E1	2.650	2.950	0.104	0.116
e	0.950(BSC)		0.037(BSC)	
e1	1.800	2.000	0.071	0.079
L	0.300	0.600	0.012	0.024
θ	0°	8°	0°	8°

Package Information
3-pin SOT89 Outline Dimensions

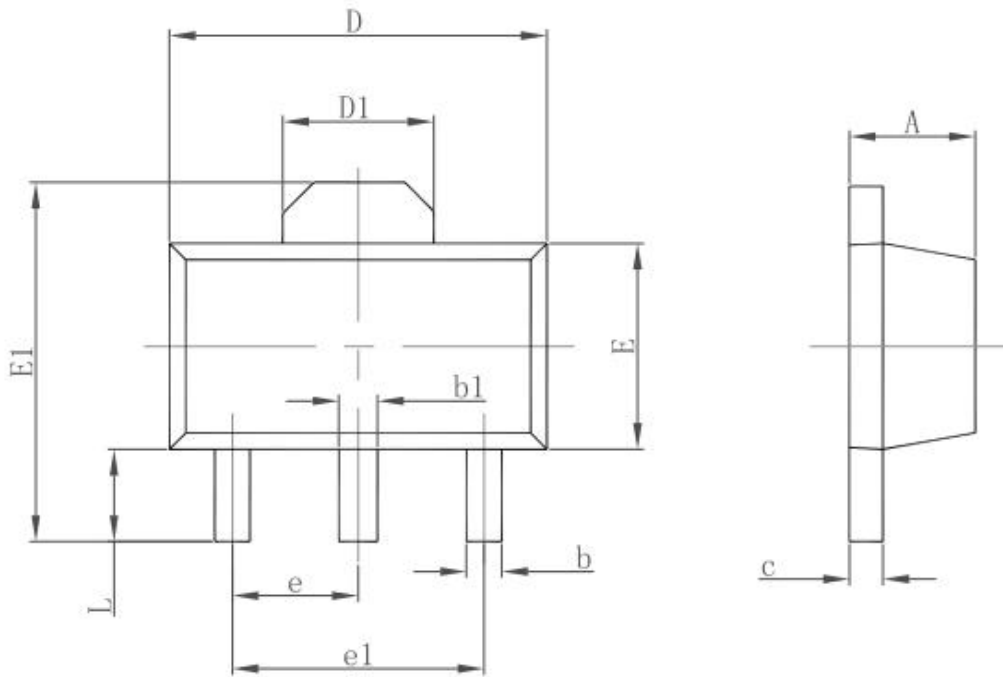

Symbol	Dimensions In Millimeters		Dimensions In Inches	
	Min.	Max.	Min.	Max.
A	1.400	1.600	0.055	0.063
b	0.320	0.520	0.013	0.020
b1	0.400	0.580	0.016	0.023
c	0.350	0.440	0.014	0.017
D	4.400	4.600	0.173	0.181
D1	1.550 REF.		0.061 REF.	
E	2.300	2.600	0.091	0.102
E1	3.940	4.250	0.155	0.167
e	1.500 TYP.		0.060 TYP.	
e1	3.000 TYP.		0.118 TYP.	
L	0.900	1.200	0.035	0.047

DFN1x1-4 Outline Dimensions

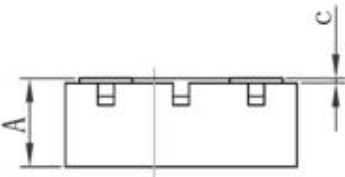
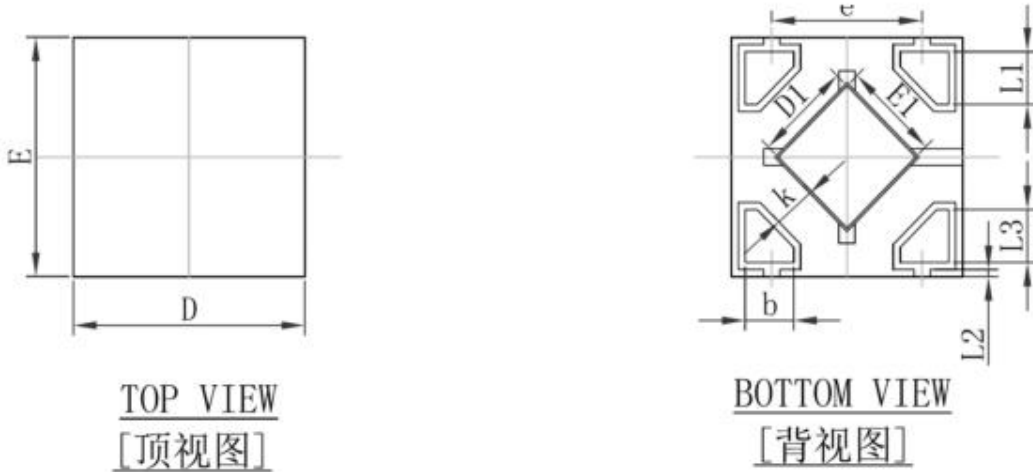

Symbol	Dimensions In Millimeters		Dimensions In Inches	
	Min.	Max.	Min.	Max.
A	0.335	0.405	0.013	0.016
D	0.950	1.050	0.037	0.041
E	0.950	1.050	0.037	0.041
D1	0.370	0.470	0.015	0.019
E1	0.370	0.470	0.015	0.019
k	0.17MIN.		0.007MIN.	
b	0.160	0.260	0.006	0.010
c	0.010	0.090	0.000	0.004
e	0.600	0.700	0.024	0.028
L1	0.185	0.255	0.007	0.010
L2	0.030 REF.		0.001 REF.	
L3	0.185	0.255	0.007	0.010

X-ON Electronics

Largest Supplier of Electrical and Electronic Components

Click to view similar products for [heermicr](#) manufacturer:

Other Similar products are found below :

[HE9073A30MR](#) [HE9073A33M5R](#) [HE9073A33PR](#) [HE9073A30PR](#) [HE9073A18M5R](#) [HE9073A15M5R](#) [HE9073A25M5R](#) [HE9073A25MR](#)

[HE9073A30M5R](#) [HE9073A12M5R](#) [HE9073A28MR](#) [HE9073A28M5R](#)