

CATEGORY	DESCRIPTION	P/N #
CONNECTOR	MU45 SMT 沉板 H=5.5mm 塑胶有破孔	MJ88-XX11-XRVS1-X

REV.	ECN NO	DESCRIPTION	REVISED	DATE
A01	—	New Release	XSY	2014.12.25
A02	—	增加塑胶颜色及包装方式选项	XSY	2018.06.27

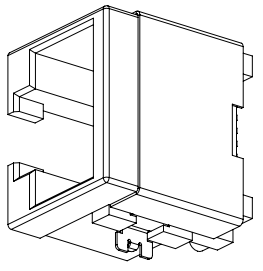

- SPECIFICATIONS:
1. Voltage: 150V AC RMS
 2. Current Rating: 1.5A
 3. Contact Resistance: 40mΩ MAX.
 4. Insulation Resistance: 500MΩ MIN.
 5. Dielectric Withstand Voltage :1000V AC
 6. Operate Temperature: -40°C~80°C
 7. Durability: 750 Mating Cycles MIN.

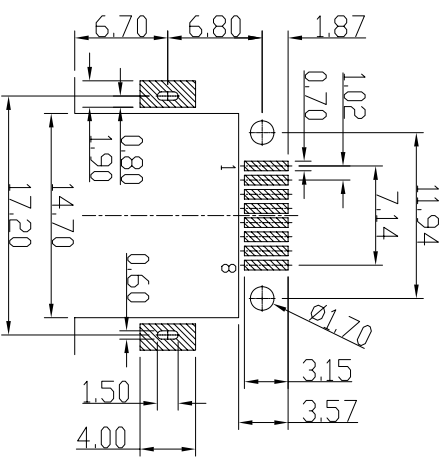
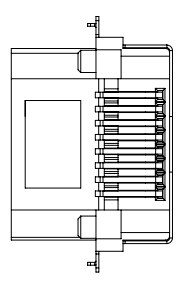
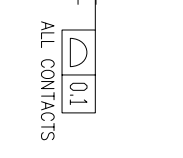
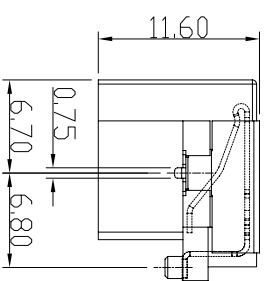
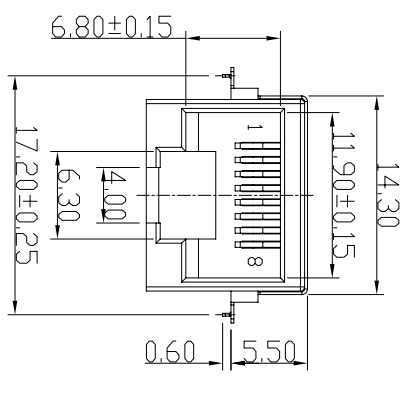
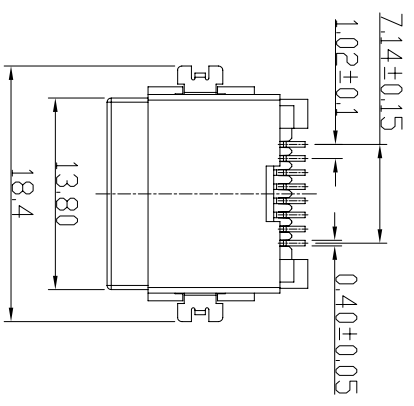

Recommend PCB Layout
lock Top View
Tolerance: ±0.05mm

TABLE

X	Terminal Plating
B	LCP BLACK
W	PA9T WHITE

Plating

X	Terminal Plating
0	Au 1u" Plating
1	Au 3u" Plating
2	Au 6u" Plating
3	Au 15u" Plating

X	包装方式
C	卷带包装
P	吸塑盒包装

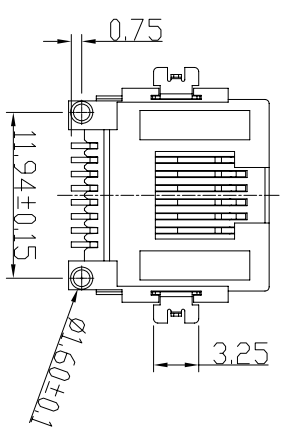

c	SHELL	1	BRASS T=0.2mm	NI PLATING	
b	TERMINAL	8	PHOSPHOR BRONZE	Au/Tin PLATING	
a	HOUSING	1	SEE TABLE	SEE TABLE	
NO.	PART NAME	Q'TY	MATERIAL	PLATING & COLOR	Remark

UNLESS OTHERWISE SPECIFIED TOLERANCES

DECIMALS: ANGLES:

X :±0.5 X :±2°
X.X :±0.3 X.X :±1°
X.XX :±0.2 X.XX :±1°

东莞市合陵电子有限公司
 DongGuan Heling Electronic Co.,LTD

SCALE: 1/1 UNIT: mm DWG.NO: WI-061-023
 SIZE: A3 PAGE: 1 OF 1 REV: A02
 APPROVED BY: XSY CHECKED BY: XSY PREPARED BY: XSY
 DICK: XSY
CUSTOMER COPY

X-ON Electronics

Largest Supplier of Electrical and Electronic Components

Click to view similar products for [Modular Connectors](#) / [Ethernet Connectors](#) category:

Click to view products by [Heling](#) manufacturer:

Other Similar products are found below :

[8949-H88/06BLKA/SN](#) [74441-0010/BKN](#) [PHP-6P6C-5](#) [GAX-3-66](#) [GAX-8-62](#) [GDCX-PN-66](#) [GLX-A-44](#) [GLX-N-1010M-BLK](#) [GMX-SMT4-N-88](#) [GSGX-N-2-88](#) [GSGX-N-4-88](#) [GSX-NS2-88-3.05](#) [GSX-NS-88-3.68](#) [PT-108A-8C-UL](#) [PTS-J531-8CS-50UL](#) [A-2014-0-4](#)
[GWLX-S9-88-YG](#) [DC-1021-8-WH-6](#) [1300530003](#) [1324640-4](#) [RJ11FTVC2G](#) [RJ11FTVC2N](#) [RJFTVX2SA1G](#) [132764-001](#) [1413235](#)
[MPS88RX-5000](#) [E5288-S000K3-L](#) [155302-001](#) [AX101050](#) [AX101063](#) [AX101065](#) [AX101072](#) [AX101307](#) [AX101314](#) [AX101315](#)
[AX101318](#) [AX102271](#) [AX102288](#) [AX102651](#) [AX102660](#) [HXJ5EOR](#) [J0012D21NL](#) [J0026D01ENL](#) [PC4D0018P](#) [8949-B88/6](#) [2-6609208-5](#)
[303066VFL](#) [303068V](#) [303088LFLSA](#) [303088SBL](#)