

20V N-Channel Enhancement Mode MOSFET

Description

The HX2302S uses advanced trench technology to provide excellent $R_{DS(ON)}$, low gate charge and high density cell Design for ultra low on-resistance. This device is suitable for use as a load switch or in PWM applications.

General Features

- ◆ $V_{DS}=20V$, $I_D=2A$
 $R_{DS(ON)}(Typ.)=50m\Omega$ @ $V_{GS}=4.5V$
 $R_{DS(ON)}(Typ.)=68m\Omega$ @ $V_{GS}=2.5V$
- ◆ High power and current handling capability
- ◆ Lead free product is acquired
- ◆ Surface mount package

Application

- ◆ PWM applications
- ◆ Load switch

Package

- ◆ SOT-23



Schematic diagram

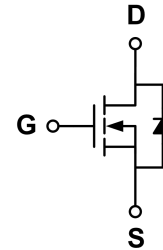

pin assignment

SOT-23
(TOP VIEW)

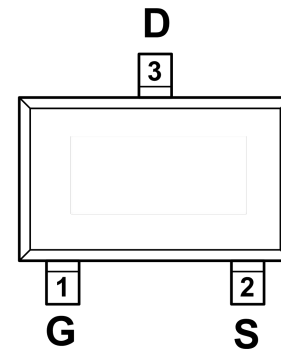

Ordering Information

Part Number	Storage Temperature	Package	Devices Per Reel
HX2302S	-55°C to +150°C	SOT-23	3000

NOTE: HX2302S : S It stands for SOT-23

Absolute Maximum Ratings (TA=25°C unless otherwise noted)

parameter	symbol	limit	unit
Drain-source voltage	V_{DS}	20	V
Gate-source voltage	V_{GS}	±12	V
Drain current-continuous ^a @Tj=125°C -pulse ^b	I_D	2	A
	I_{DM}	8	A
Drain-source Diode forward current	I_S	2	A
Maximum power dissipation	P_D	1.25	W
Operating junction Temperature range	T_j	-55—150	°C

Electrical Characteristics (TA=25°C unless otherwise noted)

Parameter	Symbol	Condition	Min	Typ	Max	Unit
OFF Characteristics						
Drain-source breakdown voltage	BV_{DSS}	$V_{GS}=0V, I_D=250\mu A$	20	-	-	V
Zero gate voltage drain current	I_{DSS}	$V_{DS}=20V, V_{GS}=0V$	-	-	1	μA
Gate-body leakage	I_{GSS}	$V_{DS}=0V, V_{GS}=\pm 12V$	-	-	± 100	nA
ON Characteristics						
Gate threshold voltage	$V_{GS(th)}$	$V_{DS}=V_{GS}, I_D=250\mu A$	0.5	0.75	1.2	V
Drain-source on-state resistance	$R_{DS(on)}$	$V_{GS}=4.5V, I_D=2A$	-	50	65	m Ω
		$V_{GS}=2.5V, I_D=1A$	-	68	88	
Forward transconductance	g_{fs}	$V_{GS}=5V, I_D=2A$	-	5	-	S
Dynamic Characteristics						
Input capacitance	C_{ISS}	$V_{DS}=10V, V_{GS}=0V$ $f=1.0MHz$	-	150	-	pF
Output capacitance	C_{OSS}		-	24	-	
Reverse transfer capacitance	C_{RSS}		-	21	-	
Switching Characteristics						
Turn-on delay time	$t_{D(ON)}$	$V_{DS}=10V$ $R_L=3\Omega$ $V_{GEN}=4.5V$ $R_{GEN}=6\Omega$	-	8	-	ns
Rise time	t_r		-	7	-	
Turn-off delay time	$t_{D(OFF)}$		-	30	-	
Fall time	t_f		-	7	-	
Total gate charge	Q_g	$V_{DS}=10V$ $I_D=3A$ $V_{GS}=4.5V$	-	3.5	-	nC
Gate-source charge	Q_{gs}		-	2.75	-	
Gate-drain charge	Q_{gd}		-	0.45	-	
DRAIN-SOURCE DIODE CHARACTERISTICS						
Diode forward voltage	V_{SD}	$V_{GS}=0V, I_S=3A$	-	0.76	1.16	V

Notes:

- surface mounted on FR4 board, $t \leq 10sec$
- pulse test: pulse width $\leq 300\mu s$, duty $\leq 2\%$
- guaranteed by design, not subject to production testing

Thermal Characteristics

Thermal Resistance junction-to ambient	$R_{\theta JA}$	100	$^{\circ}C/W$
--	-----------------	-----	---------------

Typical Performance Characteristics

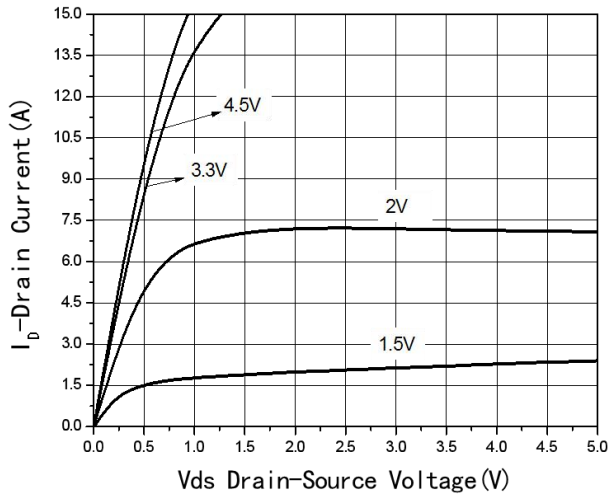

Fig1 Output Characteristics

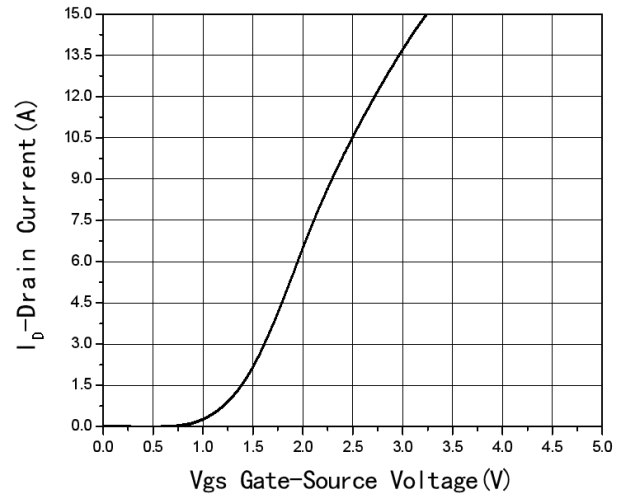

Fig2 Transfer Characteristics

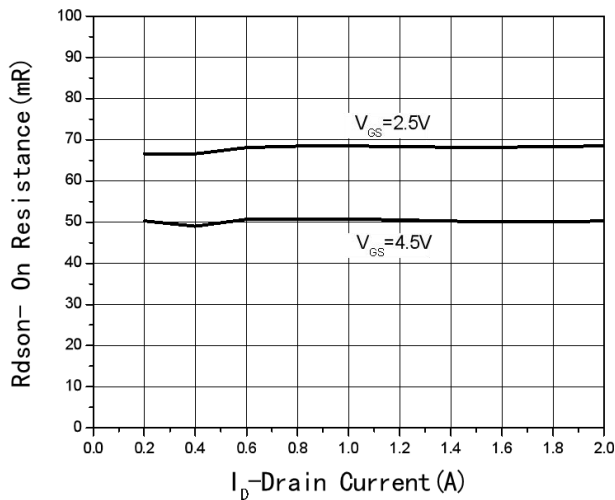

Fig3 Rdson-Drain current

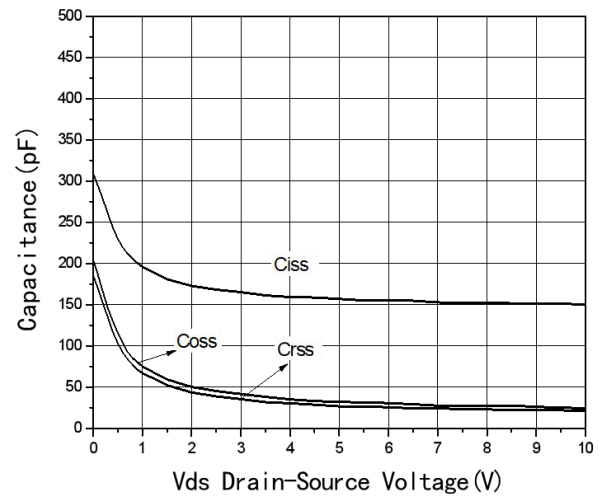

Fig4 Capacitance vs V_{DS}

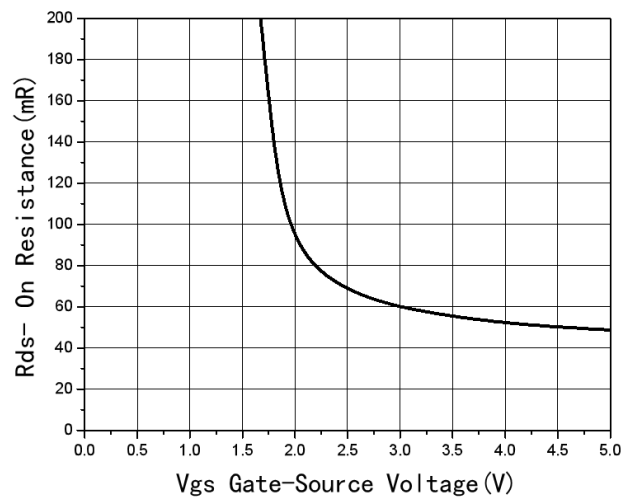

Fig5 Rdson-Gate Drain voltage

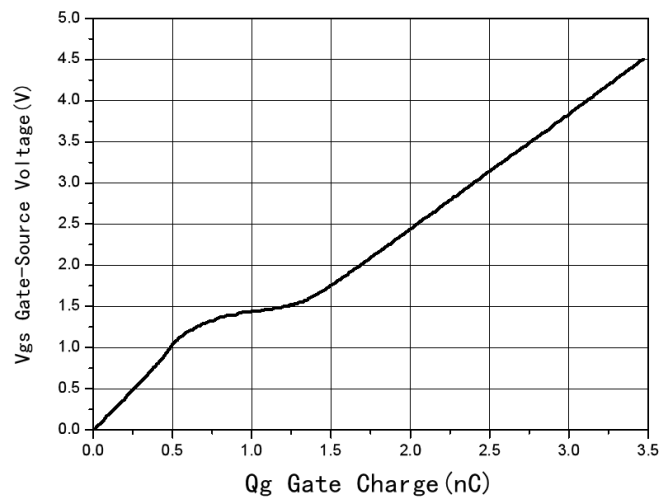

Fig6 Gate Charge

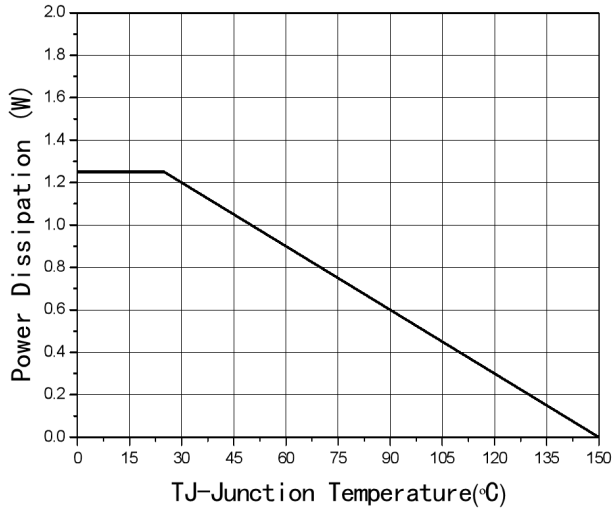

Fig7 Power De-rating

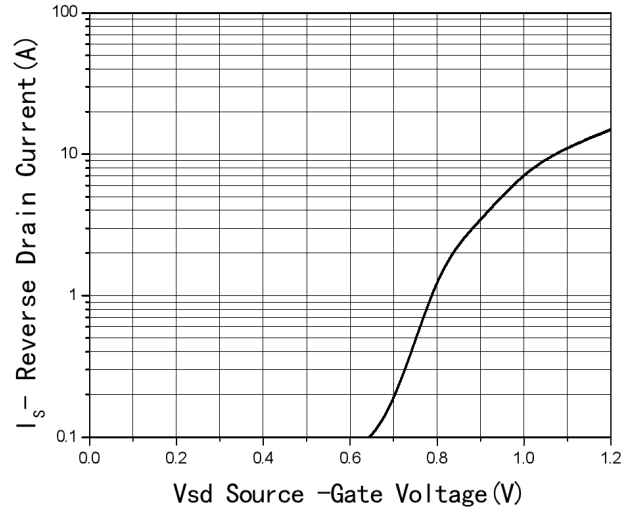
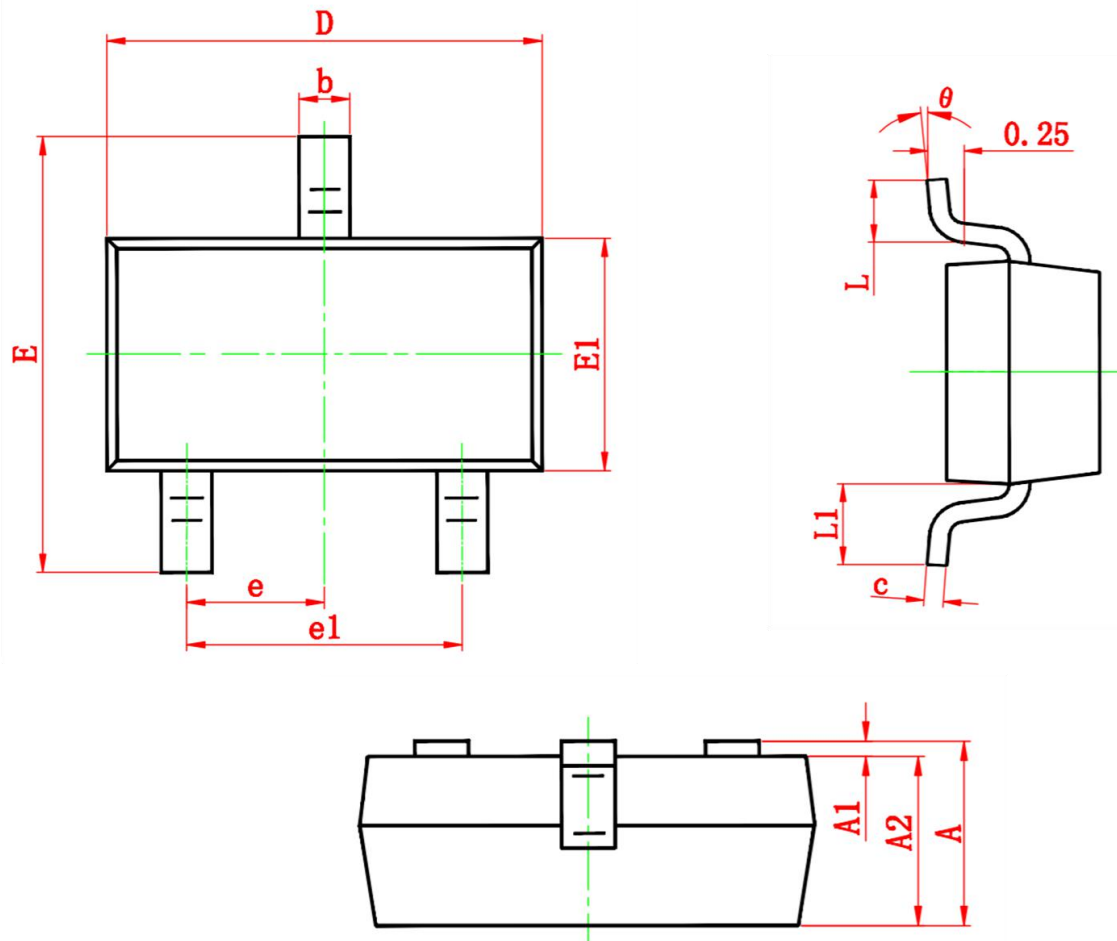

Fig8 Source-Drain Diode Forward

Package Information

- SOT-23



Symbol	Dimensions In Millimeters		Dimensions In Inches	
	Min.	Max.	Min.	Max.
A	0.900	1.150	0.035	0.045
A1	0.000	0.100	0.000	0.004
A2	0.900	1.050	0.035	0.041
b	0.300	0.500	0.012	0.020
c	0.080	0.150	0.003	0.006
D	2.800	3.000	0.110	0.118
E	2.250	2.550	0.089	0.100
E1	1.200	1.400	0.047	0.055
e	0.950 TYP.		0.037 TYP.	
e1	1.800	2.000	0.071	0.079
L	0.300	0.500	0.012	0.020
L1	0.550 REF.		0.022 REF.	
θ	0°	8°	0°	8°

X-ON Electronics

Largest Supplier of Electrical and Electronic Components

Click to view similar products for [MOSFET](#) category:

Click to view products by [hengjiaxing](#) manufacturer:

Other Similar products are found below :

[IRFD120](#) [IRFY240C](#) [JANTX2N5237](#) [BUK455-60A/B](#) [MIC4420CM-TR](#) [VN1206L](#) [NDP4060](#) [SI4482DY](#) [IPS70R2K0CEAKMA1](#)
[SQD23N06-31L-GE3](#) [TK16J60W,S1VQ\(O](#) [2SK2614\(TE16L1,Q\)](#) [DMN1017UCP3-7](#) [EFC2J004NUZTDG](#) [DMN1053UCP4-7](#) [SQJ469EP-](#)
[T1-GE3](#) [NTE2384](#) [DMC2700UDMQ-7](#) [DMN2080UCB4-7](#) [DMN61D9UWQ-13](#) [US6M2GTR](#) [DMN31D5UDJ-7](#) [DMP22D4UFO-7B](#)
[DMN1006UCA6-7](#) [DMN16M9UCA6-7](#) [STF5N65M6](#) [IRF40H233XTMA1](#) [STU5N65M6](#) [DMN6022SSD-13](#) [DMN13M9UCA6-7](#)
[DMTH10H4M6SPS-13](#) [DMN2990UFB-7B](#) [IPB80P04P405ATMA2](#) [2N7002W-G](#) [MCAC30N06Y-TP](#) [MCQ7328-TP](#) [NTMC083NP10M5L](#)
[NVMFS2D3P04M8LT1G](#) [BXP7N65D](#) [BXP4N65F](#) [AOL1454G](#) [WMJ80N60C4](#) [BXP2N20L](#) [BXP2N65D](#) [BXT1150N10J](#) [BXT1700P06M](#)
[TSM60NB380CP](#) [ROG](#) [RQ7L055BGTCR](#) [DMNH15H110SK3-13](#) [SLF10N65ABV2](#)