

Features:

- ◆ 1: 4CT Impedance
- ◆ 50Ω Impedance
- ◆ Frequency: 3 to 900 MHz
- ◆ RF power: 0.50W
- ◆ DC current: 30mA
- ◆ Good return loss
- ◆ Operating temperature range: -40°C to +85°C
- ◆ Storage temperature range: -55°C to +125°C

H2MABAES0061



3-900MHz

50 1: 4CT Flux Coupled Transformer

Applications:

- ◆ For impedance matching
- ◆ For VHF/UHF receivers/transmitters and push-pull amplifiers

Dimension Diagram (Unit:mm) :

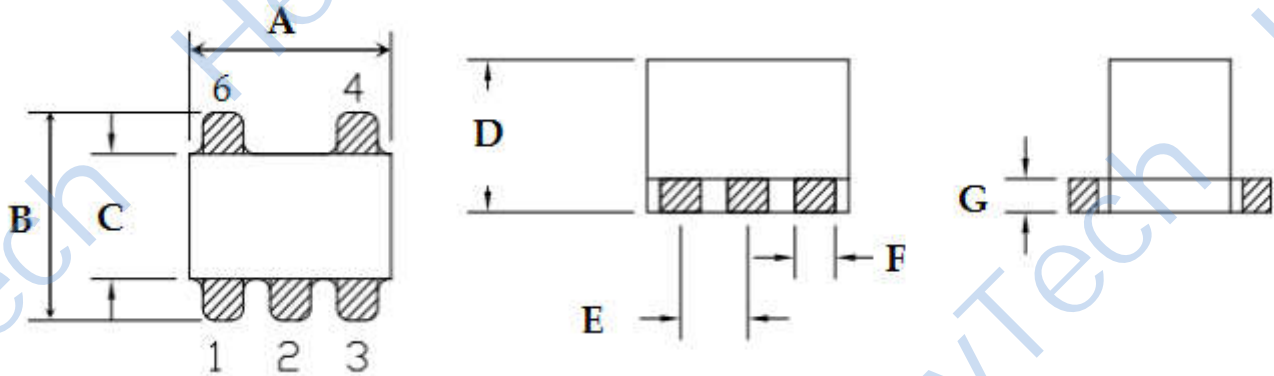

A=3.80±0.20 B=3.80±0.20 C=2.30±0.20 D=2.80±0.20 E=1.27±0.10 F=0.76±0.10 G=0.60±0.10

Electrical structure:

Recommended layout:

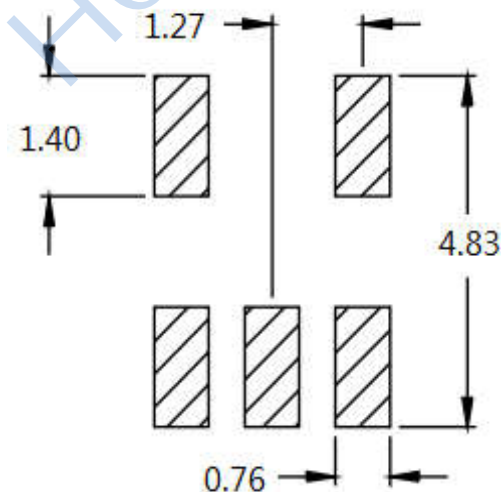
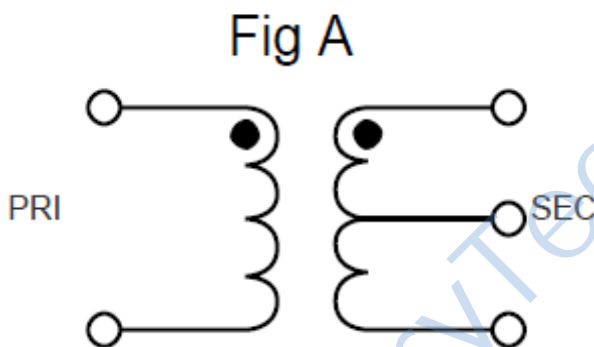

Pin configuration:

Pin No.	Function
1	Secondary (Output 2)
2	Centre tap (Ground)
3	Secondary dot (Output 1)
4	Primary dot (Input)
6	Primary (Ground)

Application circuit :

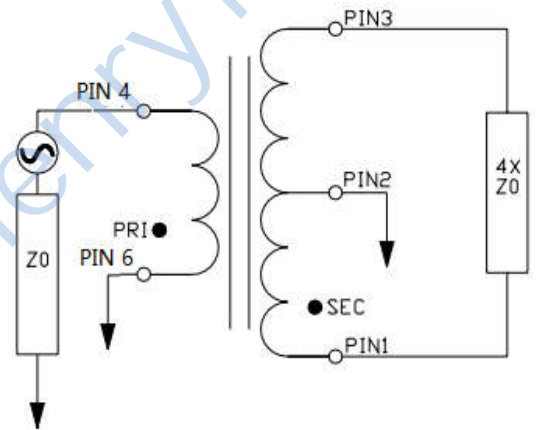

Electrical Specifications: TA=25°C, 0dBm, Z0=50Ω:

Parameter	Test Conditions	Units	Min	Typ	Max
Main line Loss(out1)	3-900MHz	dB	—	1.00	3.00
Main line Loss(out2)	3-900MHz	dB	—	0.80	3.00
Amplitude Balance	3-900MHz	dB	—	±0.50	±1.00
Phase Balance	3-900MHz	Degrees	—	±5.00	±10.00
Input Return Loss	3-900MHz	dB	10.00	20.00	—

Recommended Soldering Temperature Graph:

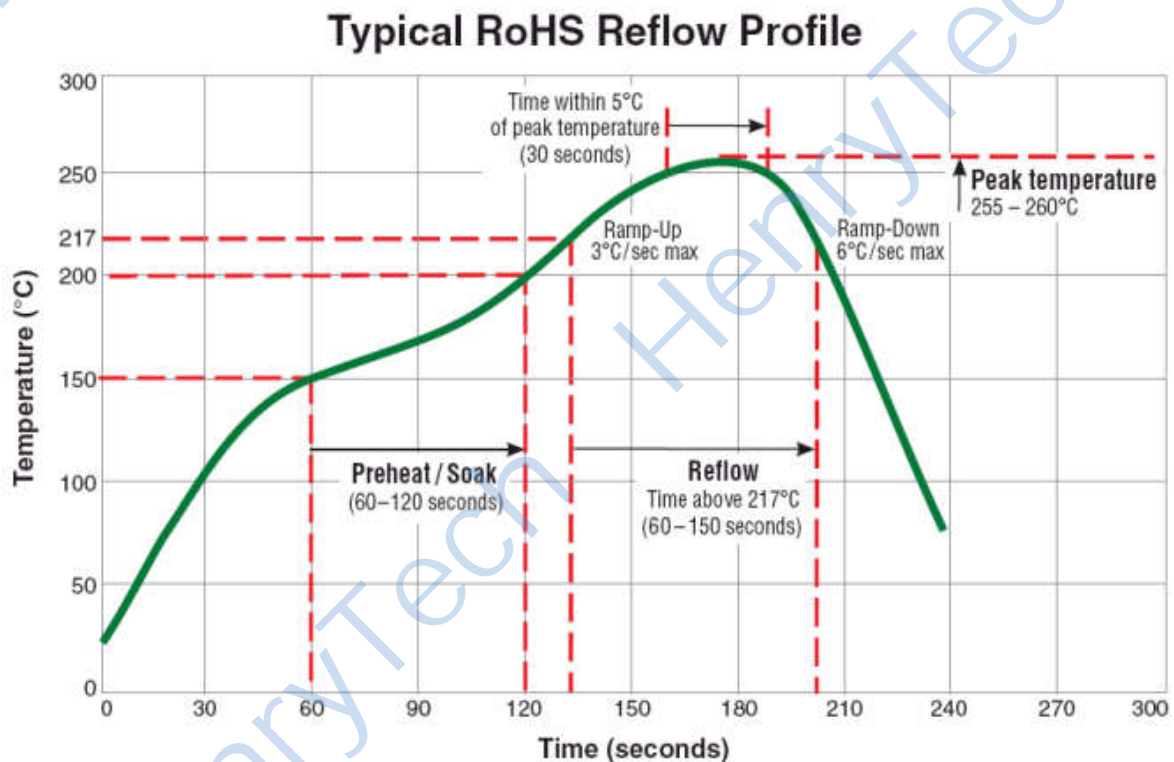

Main line Loss(out1)

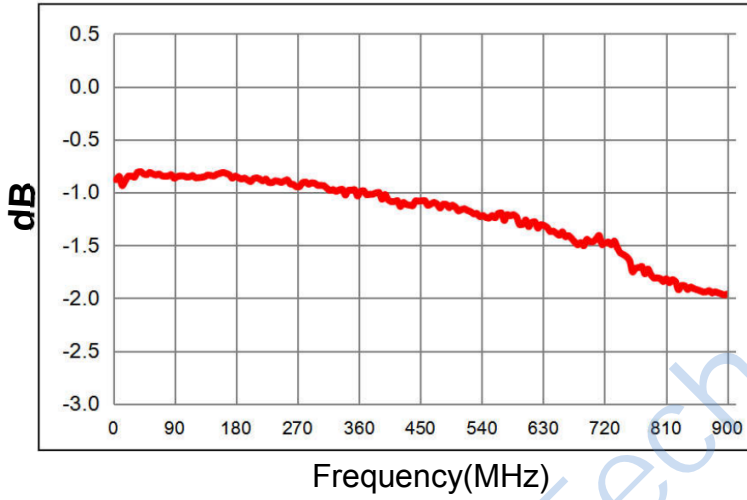

Main line Loss(out2)

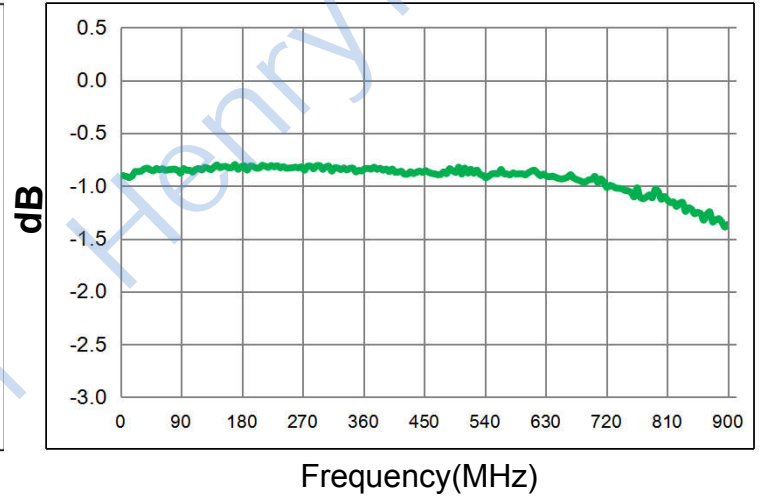

Amplitude Balance

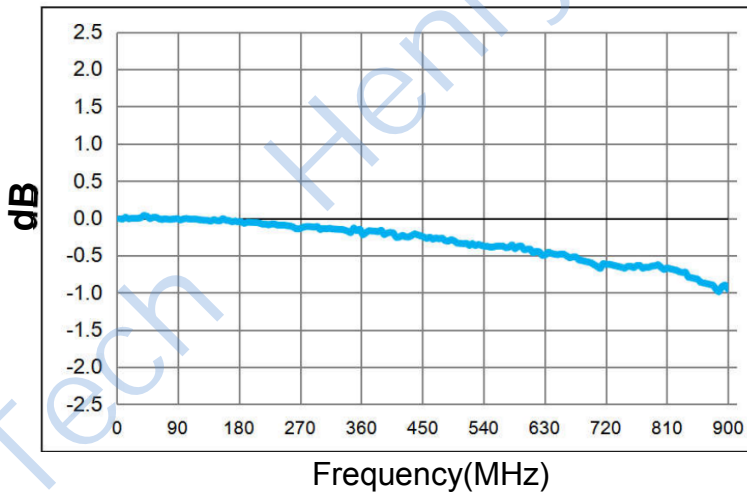

Phase Balance

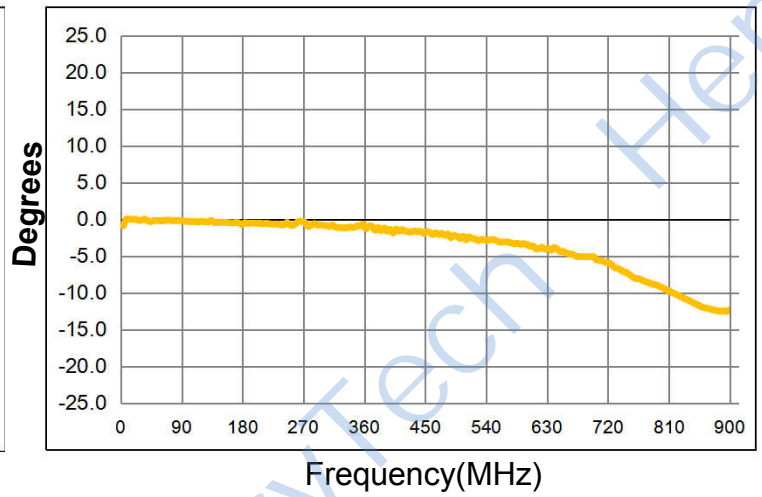

Input Return Loss

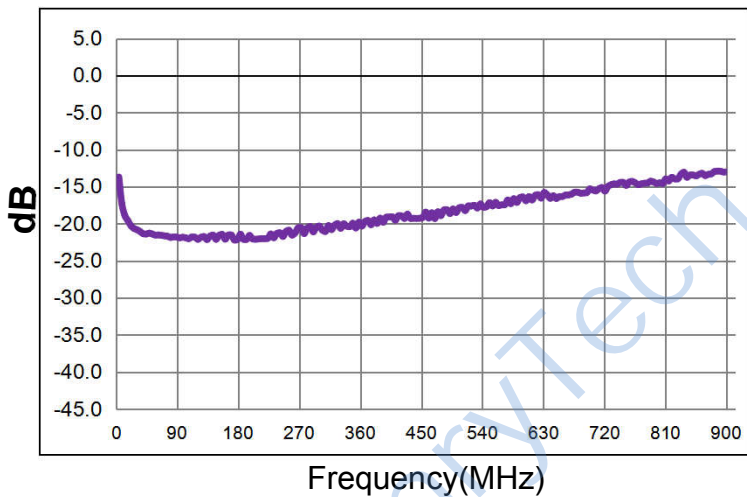

X-ON Electronics

Largest Supplier of Electrical and Electronic Components

Click to view similar products for [Signal Conditioning](#) category:

Click to view products by [HenryTech](#) manufacturer:

Other Similar products are found below :

[PD0409J5050S2HF](#) [HHS-109-PIN](#) [AFS14A35-1591.50-T3](#) [JP510S](#) [LFB322G45SN1A504](#) [SF2159E](#) [FM-104-PIN](#) [CER0813B](#)

[MAPDCC0005](#) [3A325](#) [BD0810N50100AHF](#) [DC0710J5005AHF](#) [DC2327J5005AHF](#) [LFL15869MTC1B787](#) [X3C19F1-20S](#)

[CDBLB455KCAX39-B0](#) [RF1353C](#) [051157-0000](#) [PD0922J5050D2HF](#) [600S150FTRB](#) [1E1305-3](#) [1F1304-3S](#) [TP-103-PIN](#)

[BD1222J50200AHF](#) [BD1722J50100AHF](#) [2450DP39K5400E](#) [BD0810J50150AHF](#) [BD1722J50200AHF](#) [DS-327-PIN](#) [MACP-008125-](#)

[CK07F0](#) [DS-329-PIN](#) [DS-313-PIN](#) [TP-104-PIN](#) [TP-101-PIN](#) [HH-128-PIN](#) [8594810000](#) [T-1000-N](#) [JP506S](#) [XC0900P-10S](#) [XC0900B-30S](#)

[CHE1260-QAG](#) [11305-10](#) [5962-9091202MXA](#) [3A412S](#) [X3C06A4-03S](#) [B39000Z3410A4](#) [DSS-333-PIN](#) [PD2425J5050S2HF](#)

[B39242B4360P810](#) [B39781B8005P810](#)