

Features::

H2TCP-2-33W+

- ◆ 50Ω Characteristic Impedance
- ◆ Frequency: 50to4000MHz
- ◆ Power Input(as a splitter): 0.50W Max
- ◆ DC current: 30mA
- ◆ Operating temperature range: -40°C to +85°C
- ◆ Storage temperature range: -55°C to +100°C

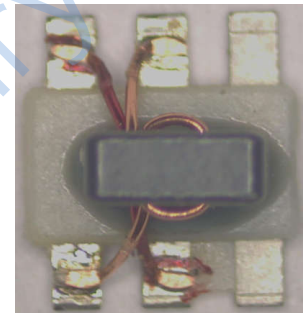

50-4000MHz

50 2 Way-0° Power Divider

Applications:

- ◆ For CATV broadband applications
- ◆ For VHF/UHF receivers/transmitters and push-pull amplifiers

Dimension Diagram (Unit:±0.20mm) :

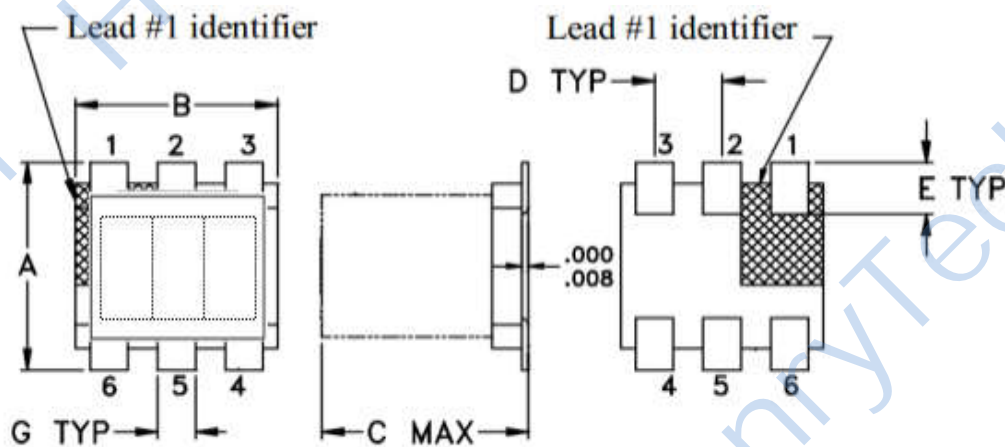

$A=4.20\pm 0.20$   $B=3.80\pm 0.20$   $C=2.80\pm 0.20$   $D=1.27\pm 0.05$   $E=1.00\pm 0.05$

Electrical structure:

Recommended layout:

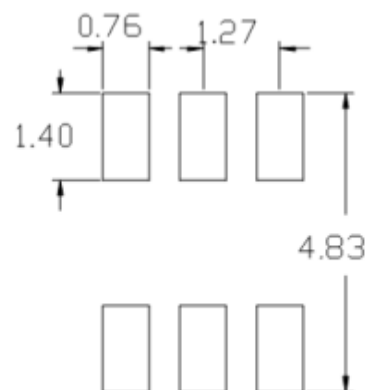
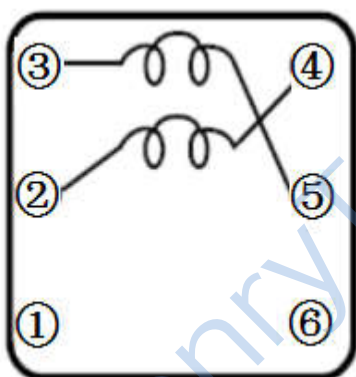

**Pin configuration:**

SUM PORT	6,5,2
PORT 1	3
PORT 2	4
GROUND	1
EXT. RESISTOR 475Ω	3,4

**Application circuit :**

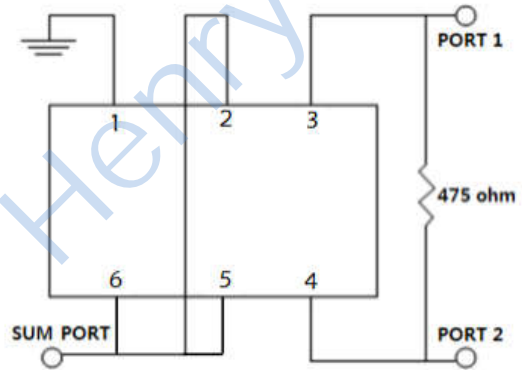

**Electrical Specifications: TA=25°C, 0dBm, Z0=50Ω**

Parameter	Test Conditions	Units	Min	Typ	Max
Main line Loss(out1)	50-4000MHz	dB	—	3.0	5.5
Main line Loss(out2)	50-4000MHz	dB	—	2.5	5.0
Amplitude balance	50-4000MHz	dB	—	1.0	1.5
Phase Balance	50-4000MHz	dB	—	8.0	12.0
Output 1 SWR	50-4000MHz	dB	—	2.0	3.5
Isolation	50-4000MHz	dB	10.0	20.0	—

**Recommended Soldering Temperature Graph:**

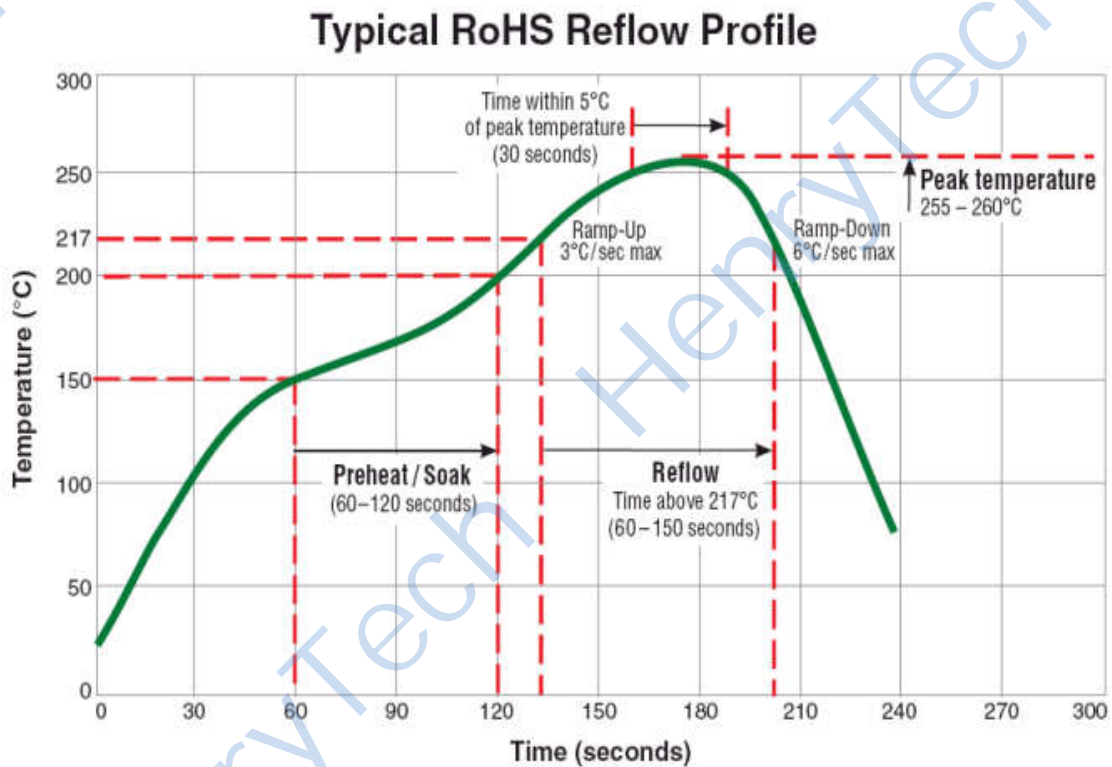

## Power Splitter/Combiner

Main line Loss(port1)

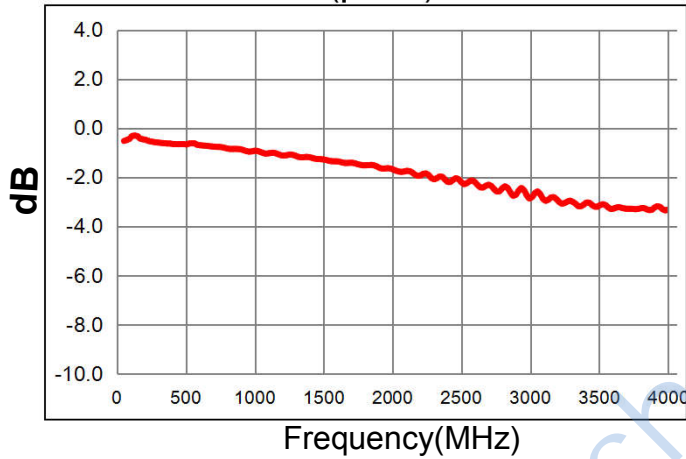

Main line Loss(port2)

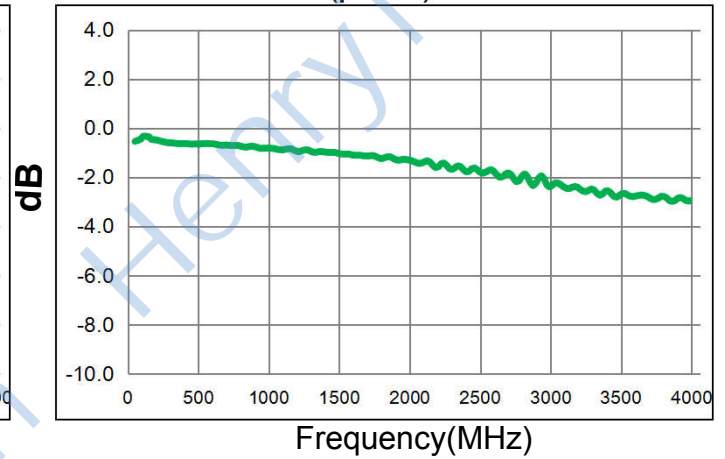

Amplitude balance

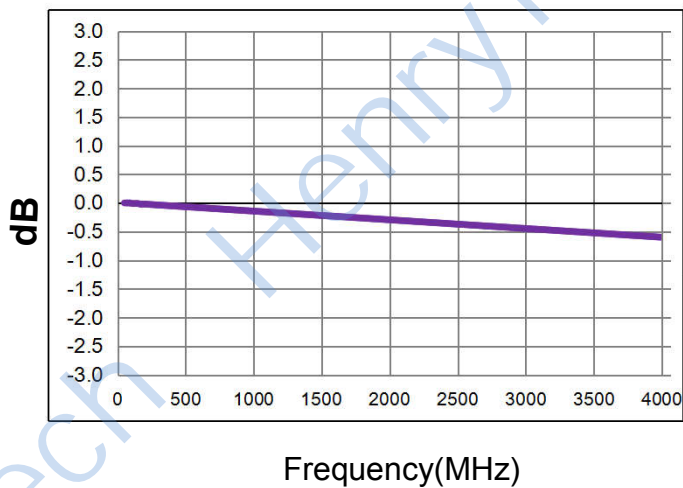

Phase Balance

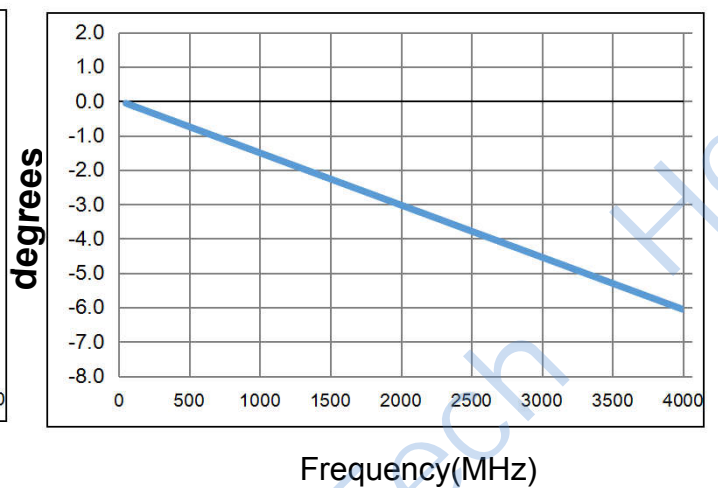

VSWR(Port S)

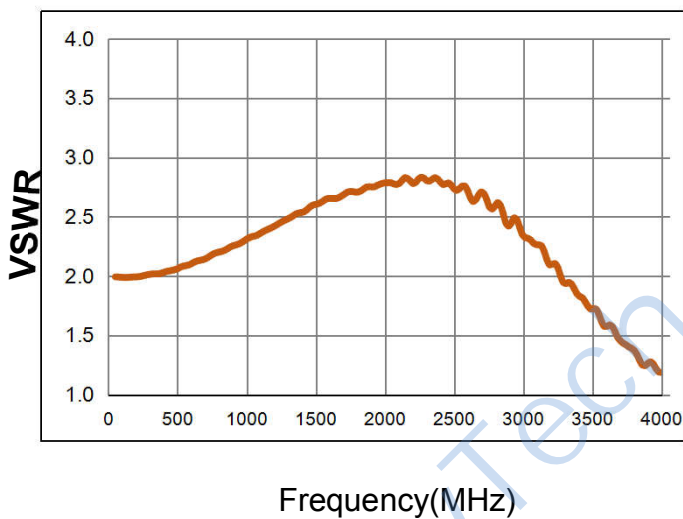

Isolation

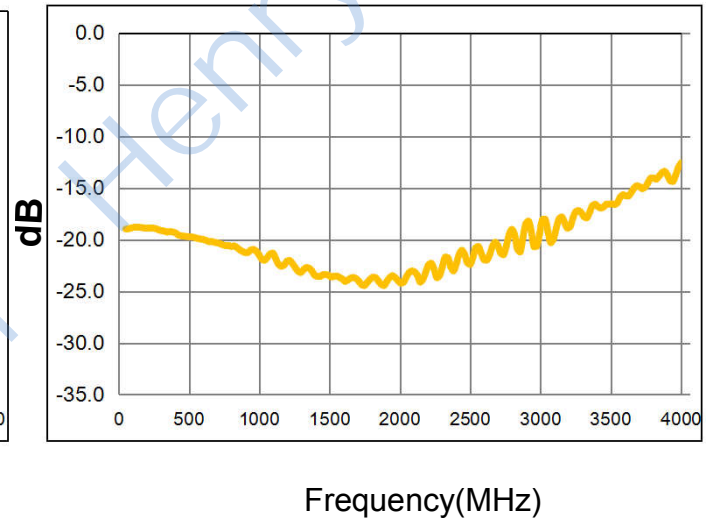

## X-ON Electronics

Largest Supplier of Electrical and Electronic Components

*Click to view similar products for [RF Wireless Misc](#) category:*

*Click to view products by [HenryTech](#) manufacturer:*

Other Similar products are found below :

[H-183-4-SMA](#) [R415720000](#) [MABT-011000-14235P](#) [TX98-4](#) [W2SW0001-SHLD](#) [PCF7991AT1081M,1](#) [TCP-3012H-QT](#) [TCP-3027H-QT](#)  
[TCP-3047H-QT](#) [TCP-3068H-QT](#) [BP4C1+](#) [SMAPD011007](#) [SBTC-2-25LX+](#) [STCP210+](#) [H2TCP-2-10+](#) [HLT-0.5/6-4S](#) [HT-SC4PS-33+](#) [HLT-](#)  
[0.5/8-4S](#) [HLT-2/8-4S](#) [HLT-2/18-2S](#) [HLT-2/8-6S](#) [H2TCP-2-33W+](#) [H2TCP-2-272+](#) [HLT-2/8-2S](#) [HLT-2/8-3S](#) [HT-SBTC-2-20+](#) [HT-SCA-4-](#)  
[10+](#) [HT-ADP-2-1+](#) [HLT-0.5/6-2S](#) [HT-TCP-2-25+](#) [HT-TCP-2-10+](#) [HLT-0.5/8-2S](#) [HT-SBTC-2-10L](#) [HT-AD4PS-1+](#) [HLT-0.5/6-8S](#)  
[MA4BN1840-1](#) [SX1308IMLTRT](#) [HMC561LP3ETR](#) [STHVDAC-253MF3](#) [ADA4304-4ACPZ-R7](#) [HMC578LC3BTR](#) [HMC814LC3BTR](#)  
[SML1](#) [CMX7032Q1](#) [KC2-36+](#) [KC2-19+](#) [KC2-11+](#) [RLM-23-1WL+](#) [RLM-33-2W+](#) [RLM-751-2WL+](#)