

Features::

- ◆ 1: 2CT Impedance
- ◆ 50Ω Characteristic Impedance
- ◆ Frequency: 0.3to500 MHz
- ◆ RF power: 0.25W
- ◆ DC current: 30mA
- ◆ Operating temperature range: -40℃ to +85℃
- ◆ Storage temperature range: -55℃ to +100℃

H2WBC2-1TL



0.3-500MHz

Applications:

- ◆ For broadband and wireless communications
- ◆ For VHF/UHF receivers/transmitters and push-pull amplifiers

50 1: 2CT Flux Coupled Transformer

Dimension Diagram (Unit:mm) :

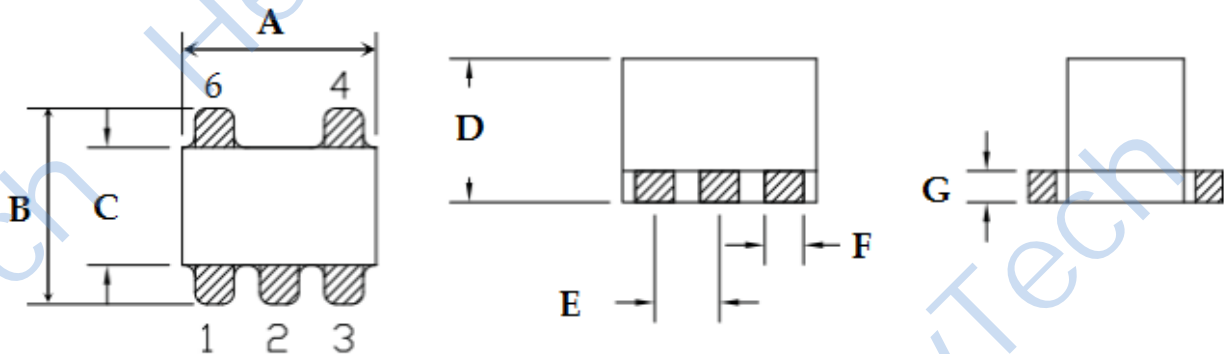

A=3.80±0.20 B=3.80±0.20 C=2.30±0.20 D=2.80±0.20 E=1.27±0.10 F=0.76±0.10 G=0.60±0.10

Electrical structure:

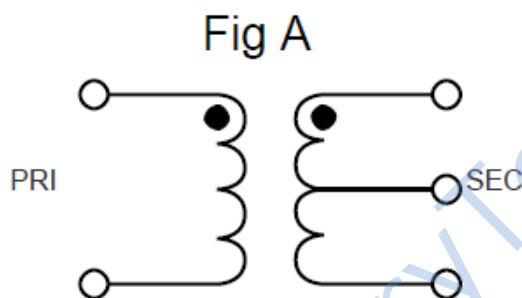

Recommended layout:

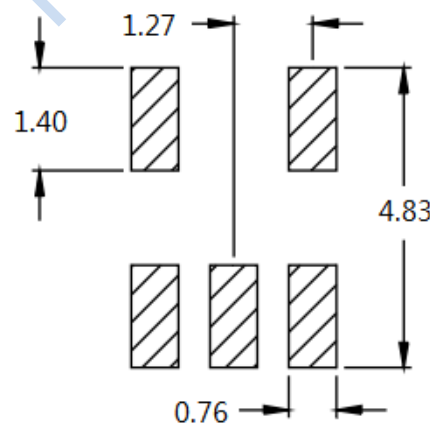

**Pin configuration:**

**Application circuit :**

Pin No.	Function
1	Secondary (Output 2)
2	Centre tap (Ground)
3	Secondary dot (Output 1)
4	Primary dot (Input)
6	Primary (Ground)

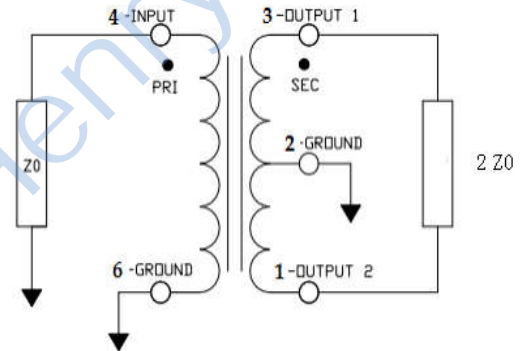

Electrical Specifications: T A=25°C Z0=50Ω

Parameter	Test Conditions	Units	Min	Typ	Max
Main line Loss(out1)	0.3-500MHz	dB	—	1.50	2.50
Main line Loss(out2)	0.3-500MHz	dB	—	0.50	1.50
Amplitude Balance	0.3-500MHz	dB	—	±1.5	±2.00
Phase Balance	0.3-500MHz	°	—	±5.00	±10.00
Input Return Loss	0.3-500MHz	dB	10.00	18.00	—

**Recommended Soldering Temperature Graph:**

**Typical RoHS Reflow Profile**

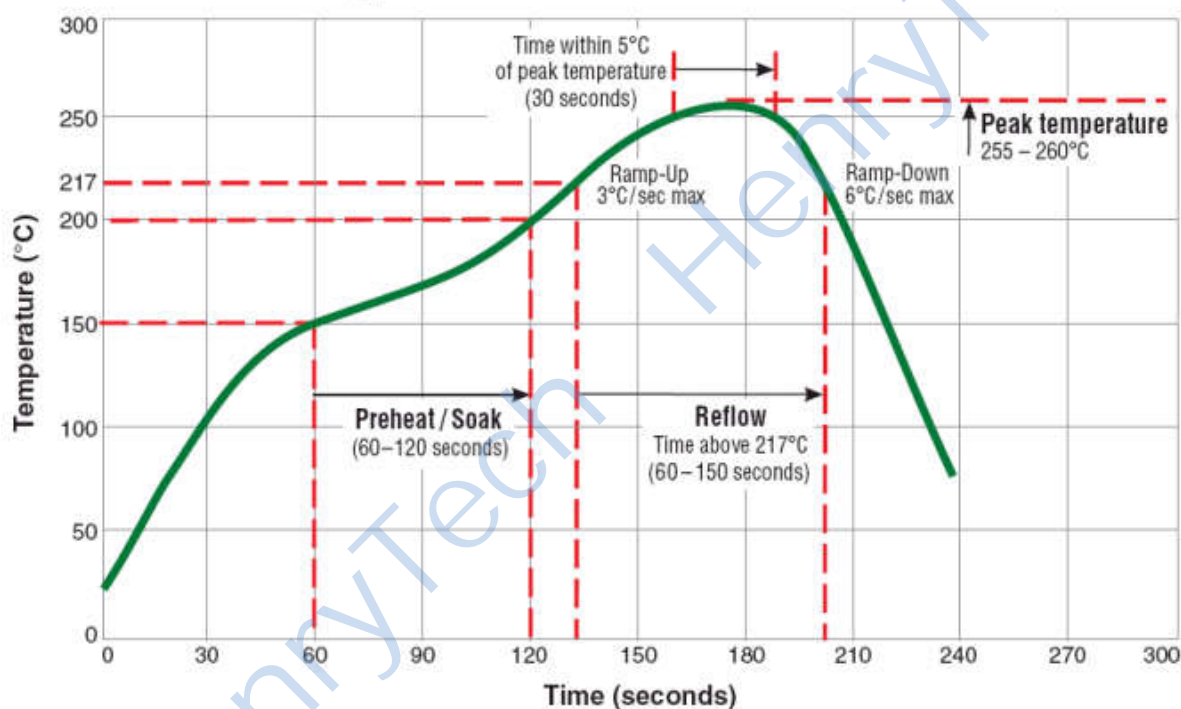

## RF Balun Transformer

### Main line Loss(out1)

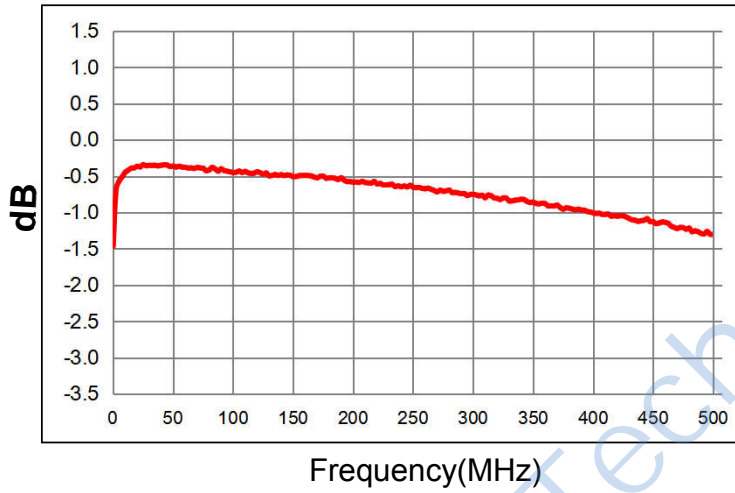

### Main line Loss(out2)

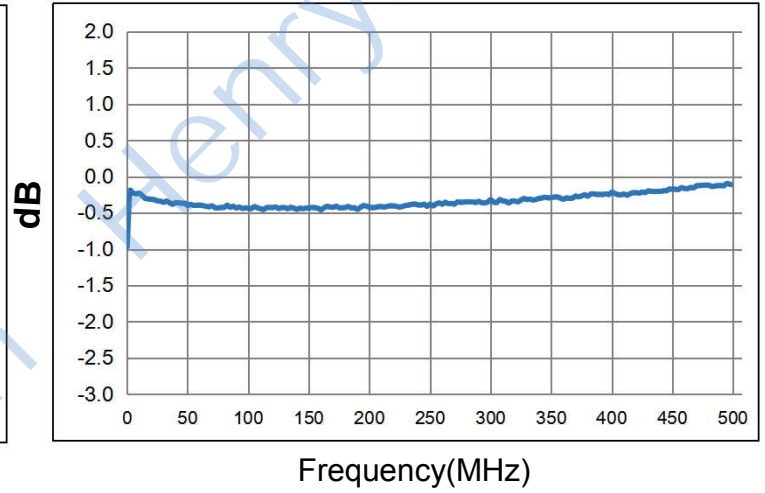

### Amplitude Balance

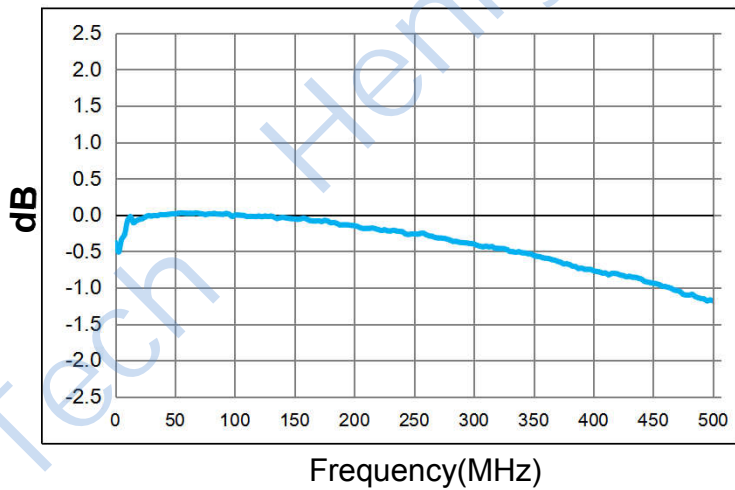

### Phase Balance

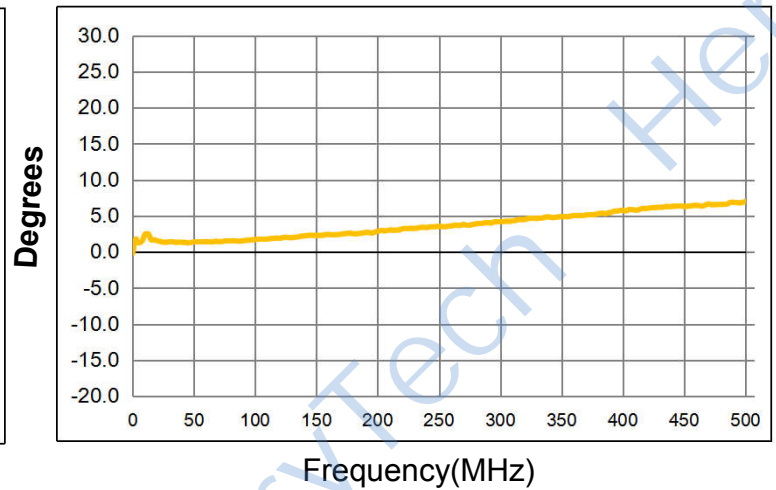

### Input Return Loss

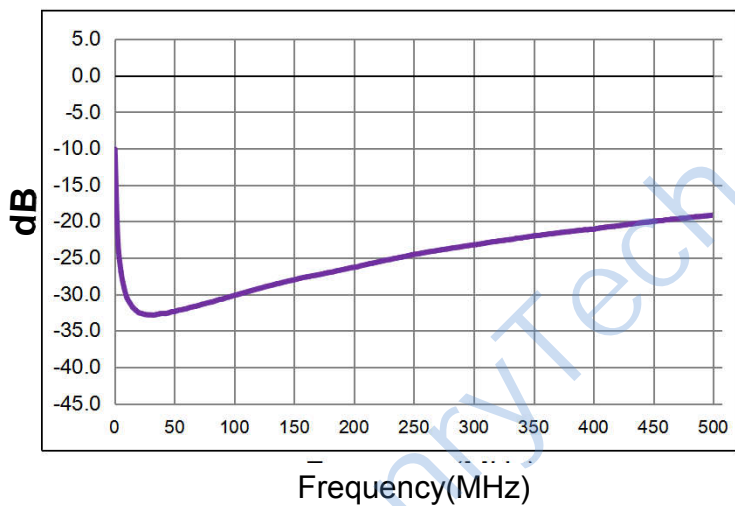

## X-ON Electronics

Largest Supplier of Electrical and Electronic Components

*Click to view similar products for [Signal Conditioning](#) category:*

*Click to view products by [HenryTech](#) manufacturer:*

Other Similar products are found below :

[PD0409J5050S2HF](#) [HHS-109-PIN](#) [AFS14A35-1591.50-T3](#) [JP510S](#) [LFB322G45SN1A504](#) [SF2159E](#) [FM-104-PIN](#) [CER0813B](#)

[MAPDCC0005](#) [3A325](#) [BD0810N50100AHF](#) [DC0710J5005AHF](#) [DC2327J5005AHF](#) [LFL15869MTC1B787](#) [X3C19F1-20S](#)

[CDBLB455KCAX39-B0](#) [RF1353C](#) [051157-0000](#) [PD0922J5050D2HF](#) [600S150FTRB](#) [1E1305-3](#) [1F1304-3S](#) [TP-103-PIN](#)

[BD1222J50200AHF](#) [BD1722J50100AHF](#) [2450DP39K5400E](#) [BD0810J50150AHF](#) [BD1722J50200AHF](#) [DS-327-PIN](#) [MACP-008125-](#)

[CK07F0](#) [DS-329-PIN](#) [DS-313-PIN](#) [TP-104-PIN](#) [TP-101-PIN](#) [HH-128-PIN](#) [8594810000](#) [T-1000-N](#) [JP506S](#) [XC0900P-10S](#) [XC0900B-30S](#)

[CHE1260-QAG](#) [11305-10](#) [5962-9091202MXA](#) [3A412S](#) [X3C06A4-03S](#) [B39000Z3410A4](#) [DSS-333-PIN](#) [PD2425J5050S2HF](#)

[B39242B4360P810](#) [B39781B8005P810](#)