

H3-MABA-007237-ETC410

1-350MHz 50Ω 1:4 Balun

APPLICATIONS

• Ideally suited for high volume cellular and wireless application.

FEATURES

- Surface mount
- Impedance ratio: 1:4
- Available on tape and reel
- RoHS compliant and Pb free
- 260°C reflow compatible

DIMENSIONS

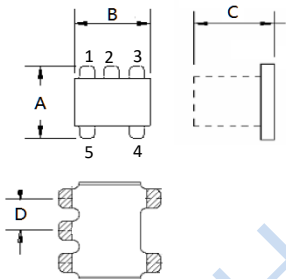

A	B	C
3.81	3.81	2.73
D		
1.27		

Land Pattern

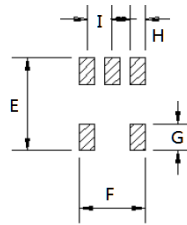

E	F	G
4.83	3.30	1.40
H	J	
0.76	1.27	

Unless otherwise stated dimensions are in mm

Tolerance: .xx ± 0.25, .xxx ± 0.05

ELECTRICAL SPECIFICATIONS@25°C:

Parameters (P#: ENA PORT)	frequency band	Min.	Typ.	Max.	Unit
Port Impedance, Z0 (P1 / P2 / P3)			50/100/100		Ohm
Insertion Loss	5-100MHz		0.7	1.0	dB
	2-300MHz		1.1	2.0	dB
	1-350MHz		1.2	3.0	dB
Amplitude Balance	5-100MHz		0.02	0.1	dB
	1-350MHz		0.12	0.5	dB
Phase Balance (Nominal 180°)	5-100MHz		0.5	1	Deg
	1-350MHz		2.0	5	Deg

FUNCTIONAL SCHEMATIC

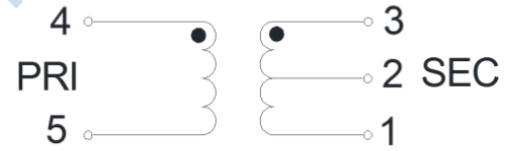

PIN CONFIGURATION

Pin No.	Function
1	Secondary Dot
2	Secondary CT
3	Secondary
4	Primary
5	Primary Dot

APPLICATION & TEST CIRCUIT

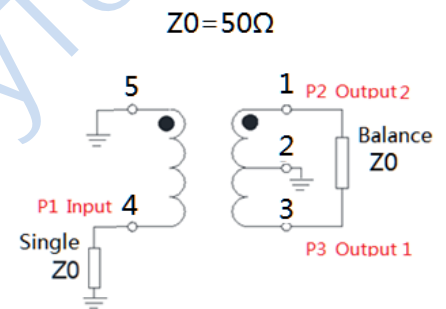

ABSOLUTE MAXIMUM RATINGS

Parameter	Value
Input Power	250mW MAX
DC Current	30mA MAX
Operating Temperature Range	-40 to 85°C

TEST CURVE

Insertion Loss

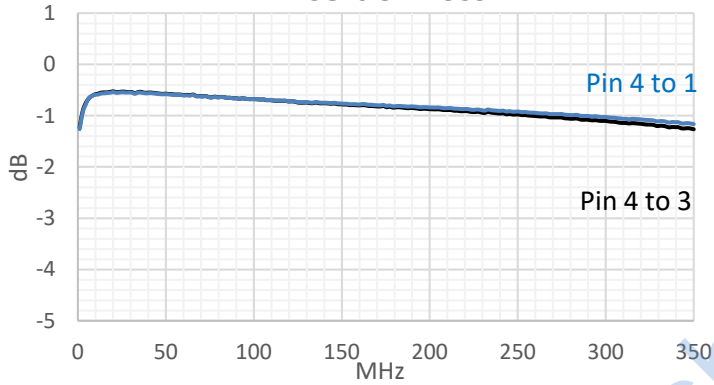

Input Return Loss: Pin 4

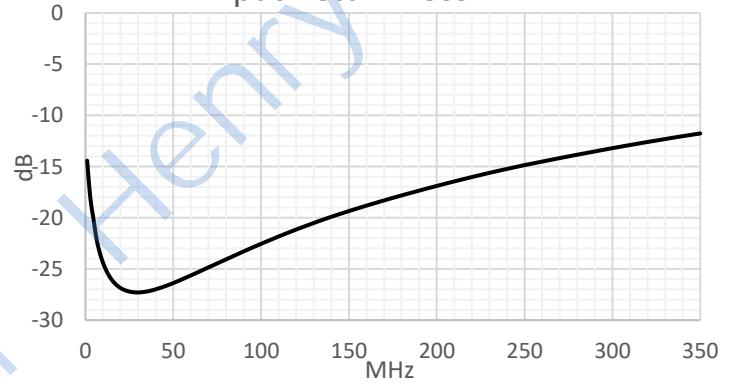

Amplitude Balance

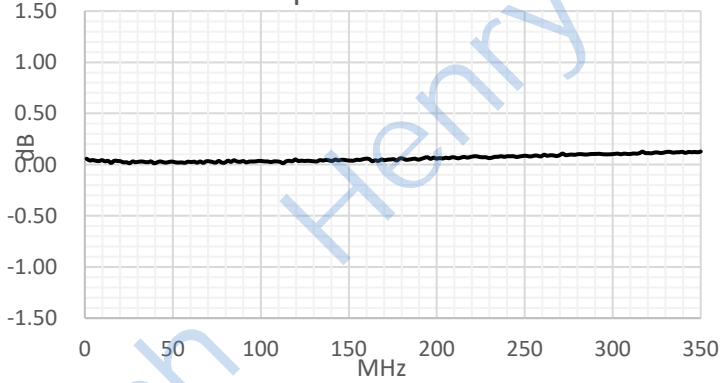

Phase Balance

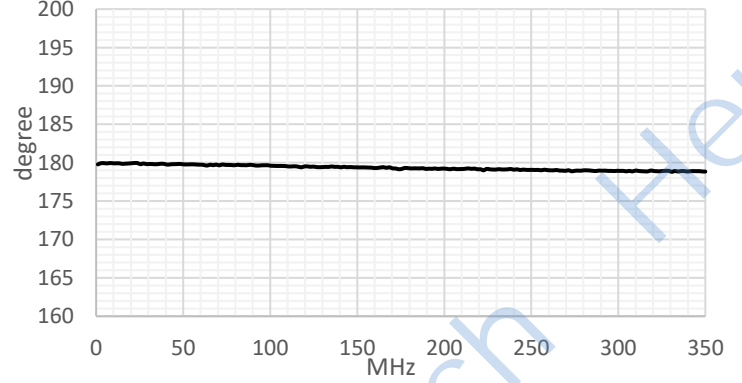

X-ON Electronics

Largest Supplier of Electrical and Electronic Components

Click to view similar products for [Signal Conditioning](#) category:

Click to view products by [HenryTech](#) manufacturer:

Other Similar products are found below :

[PD0409J5050S2HF](#) [HHS-109-PIN](#) [AFS14A35-1591.50-T3](#) [JP510S](#) [LFB322G45SN1A504](#) [SF2159E](#) [FM-104-PIN](#) [CER0813B](#)

[MAPDCC0005](#) [3A325](#) [BD0810N50100AHF](#) [DC0710J5005AHF](#) [DC2327J5005AHF](#) [LFL15869MTC1B787](#) [X3C19F1-20S](#)

[CDBLB455KCAX39-B0](#) [RF1353C](#) [051157-0000](#) [PD0922J5050D2HF](#) [600S150FTRB](#) [1E1305-3](#) [1F1304-3S](#) [TP-103-PIN](#)

[BD1222J50200AHF](#) [BD1722J50100AHF](#) [2450DP39K5400E](#) [BD0810J50150AHF](#) [BD1722J50200AHF](#) [DS-327-PIN](#) [MACP-008125-](#)

[CK07F0](#) [DS-329-PIN](#) [DS-313-PIN](#) [TP-104-PIN](#) [TP-101-PIN](#) [HH-128-PIN](#) [8594810000](#) [T-1000-N](#) [JP506S](#) [XC0900P-10S](#) [XC0900B-30S](#)

[CHE1260-QAG](#) [11305-10](#) [5962-9091202MXA](#) [3A412S](#) [X3C06A4-03S](#) [B39000Z3410A4](#) [DSS-333-PIN](#) [PD2425J5050S2HF](#)

[B39242B4360P810](#) [B39781B8005P810](#)