

## H3-MABA-009601-CF18A0

5-200MHz 75Ω 1:1 Balun

### APPLICATIONS

• Ideally suitable for CATV broadband applications.

### FEATURES

- Surface mount
- Impedance ratio: 1:1
- Centre tap on secondary
- RoHS compliant and Pb free
- Available on tape and reel
- Suitable for DOCSIS 3.0

### DIMENSIONS

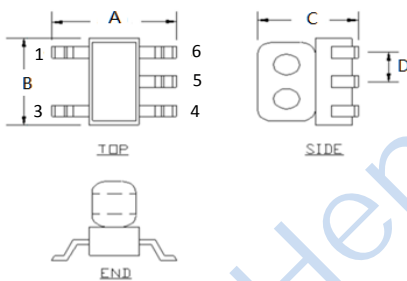

A	B	C
5.30	4.21	3.72
D		
1.50		

### Land Pattern

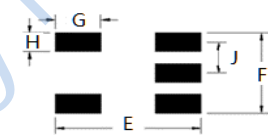

E	F	G
6.13	3.91	1.92
H	J	
0.91	1.50	

Unless otherwise stated dimensions are in mm

Tolerance: .xx ± 0.25, .xxx ± 0.05

### ELECTRICAL SPECIFICATIONS@25°C:

Parameters (P#: ENA PORT)	frequency band	Min.	Typ.	Max.	Unit
Port Impedance, Z0 (P1 / P2 / P3)			75 / 37.5 / 37.5		Ohm
Insertion Loss	5-60MHz		0.4	0.5	dB
	60-150MHz		0.5	0.8	dB
	150-200MHz		0.7	1.1	dB
Input Return Loss (Pin 1)	5-60MHz	20.0	28.0		dB
	60-200MHz	10.0	17.0		dB
Amplitude Balance	5-60MHz		0.02	0.1	dB
	60-200MHz		0.40	0.6	dB
Phase Balance (ref value 180° Deg)	5-60MHz		0.1	1.0	Deg
	60-200MHz		1.5	3.0	Deg

### FUNCTIONAL SCHEMATIC

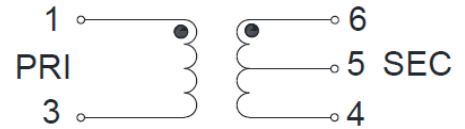

### PIN CONFIGURATION

Pin No.	Function
1	Primary Dot
3	Primary
4	Secondary
5	Centre Tap
6	Secondary Dot

### APPLICATION & TEST CIRCUIT

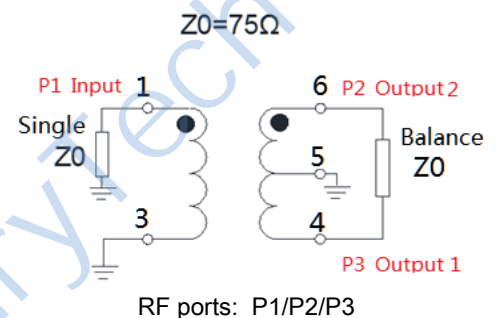

### ABSOLUTE MAXIMUM RATINGS

Parameter	Value
Input RF Power(+28dBm)	631mW Max
DC Current(tested at 5V)	600mA Max
Operating Temperature Range	-40 to 85°C

## TEST CURVE

Insertion Loss: Pin 1 to Pin 6

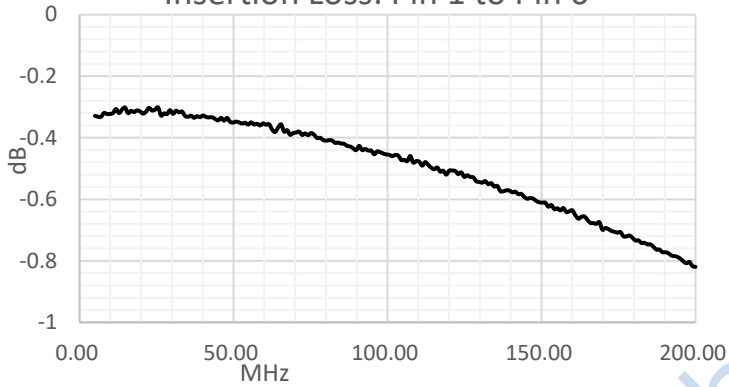

Insertion Loss: Pin 1 to Pin4

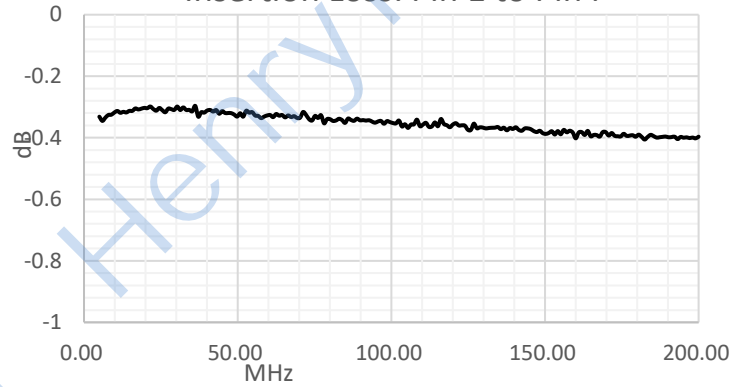

Amplitude Balance

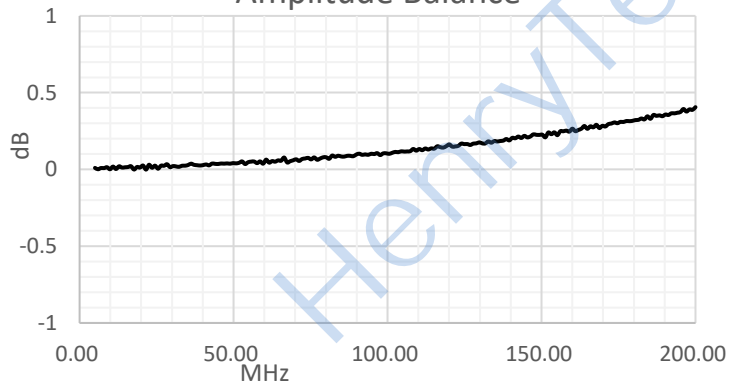

Phase Balance

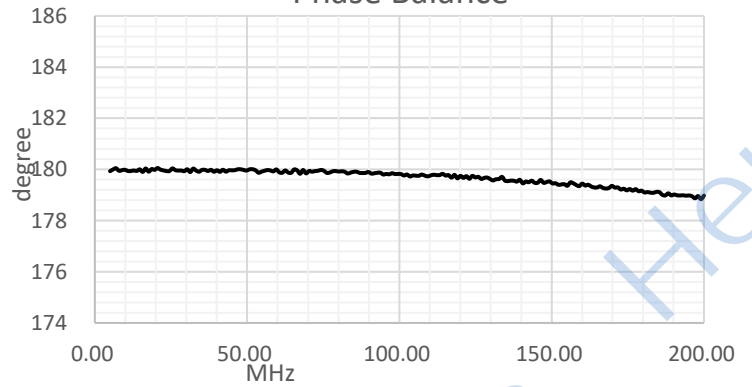

Input Return Loss: Pin 1

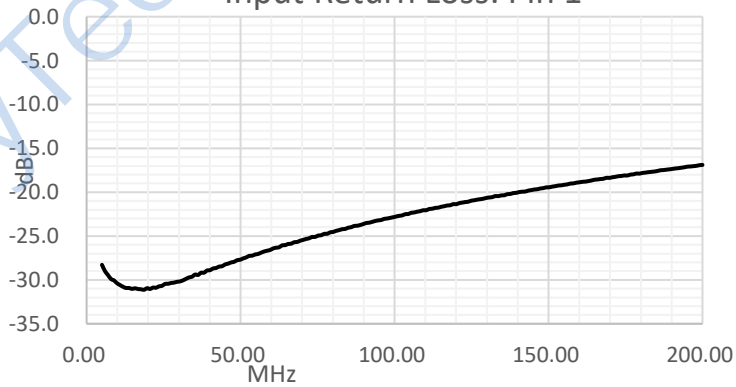

## X-ON Electronics

Largest Supplier of Electrical and Electronic Components

*Click to view similar products for [Signal Conditioning](#) category:*

*Click to view products by [HenryTech](#) manufacturer:*

Other Similar products are found below :

[PD0409J5050S2HF](#) [HHS-109-PIN](#) [AFS14A35-1591.50-T3](#) [JP510S](#) [LFB322G45SN1A504](#) [SF2159E](#) [FM-104-PIN](#) [CER0813B](#)  
[MAPDCC0005](#) [3A325](#) [BD0810N50100AHF](#) [DC0710J5005AHF](#) [DC2327J5005AHF](#) [LFL15869MTC1B787](#) [X3C19F1-20S](#)  
[CDBLB455KCAX39-B0](#) [RF1353C](#) [051157-0000](#) [PD0922J5050D2HF](#) [600S150FTRB](#) [1E1305-3](#) [1F1304-3S](#) [TP-103-PIN](#)  
[BD1222J50200AHF](#) [BD1722J50100AHF](#) [2450DP39K5400E](#) [BD0810J50150AHF](#) [BD1722J50200AHF](#) [DS-327-PIN](#) [MACP-008125-](#)  
[CK07F0](#) [DS-329-PIN](#) [DS-313-PIN](#) [TP-104-PIN](#) [TP-101-PIN](#) [HH-128-PIN](#) [8594810000](#) [T-1000-N](#) [JP506S](#) [XC0900P-10S](#) [XC0900B-30S](#)  
[CHE1260-QAG](#) [11305-10](#) [5962-9091202MXA](#) [3A412S](#) [X3C06A4-03S](#) [B39000Z3410A4](#) [DSS-333-PIN](#) [PD2425J5050S2HF](#)  
[B39242B4360P810](#) [B39781B8005P810](#)