

H3-MABAES0061

2-800MHz 50Ω 1:4 Balun

APPLICATIONS

• Ideally suited for high volume cellular and wireless application.

FEATURES

- Surface mount
- Impedance ratio: 1:4
- Available on tape and reel
- RoHS compliant and Pb free
- 260°C reflow compatible
- CT on Secondary

DIMENSIONS

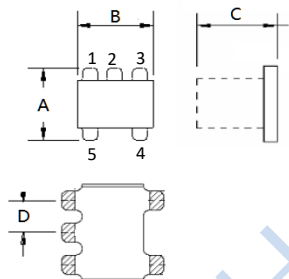

A	B	C
3.81	3.81	2.90MAX
D		
1.27		

Unless otherwise stated dimensions are in mm

Tolerance: .xx ± 0.25, .xxx ± 0.05

Land Pattern

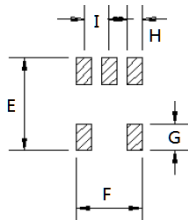

E	F	G
4.83	3.30	1.40
H	J	
0.76	1.27	

FUNCTIONAL SCHEMATIC

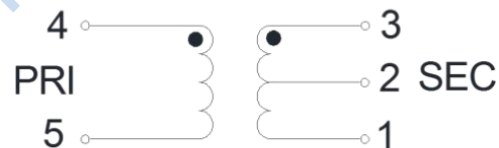

PIN CONFIGURATION

Pin No.	Function
1	Secondary Dot
2	Secondary CT
3	Secondary
4	Primary
5	Primary Dot

APPLICATION & TEST CIRCUIT

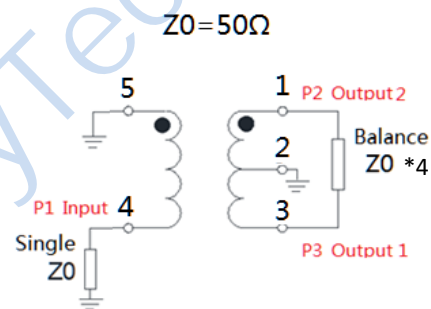

ELECTRICAL SPECIFICATIONS@25°C:

Parameters (P#: ENA PORT)	frequency band	Min.	Typ.	Max.	Unit
Port Impedance, Z0 (P1 / P2 / P3)			50/100/100		Ohm
Insertion Loss	10-100MHz		0.8	1.0	dB
	5-600MHz		1.2	2.0	dB
	2-800MHz		2.3	3.0	dB
Amplitude Balance	10-100MHz		0.05	0.25	dB
	2-800MHz		0.6	1.0	dB
Phase Balance (Nominal 180°)	10-500MHz		1.3	2	Deg
	2-800MHz		6.4	10	Deg

External DC blocking capacitors are required on all RF ports (39 pF capacitors are recommended).

ABSOLUTE MAXIMUM RATINGS

Parameter	Value
Input Power	250mW MAX
DC Current	30mA MAX
Operating Temperature Range	-55 to 85°C

Tel: +86-28-85589664

E-mail: mr_li@henglitaitech.com

Web: www.hltchips.com

Address: No.198 Tianqin East Street, Gaoxin West District, Chengdu City

TEST CURVE

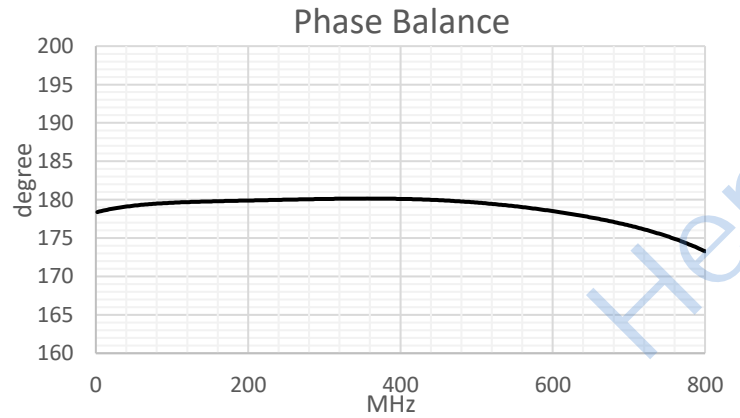
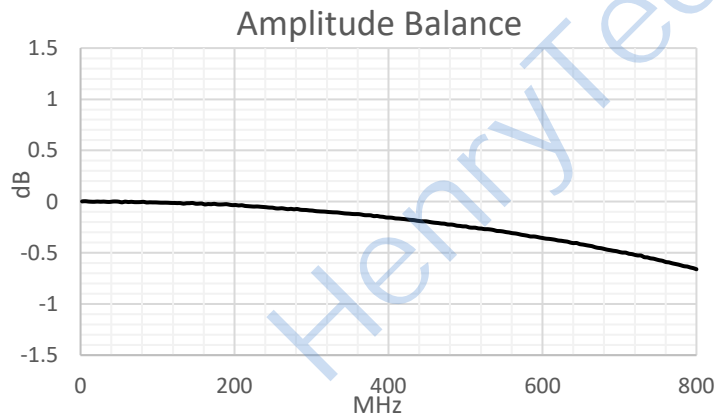
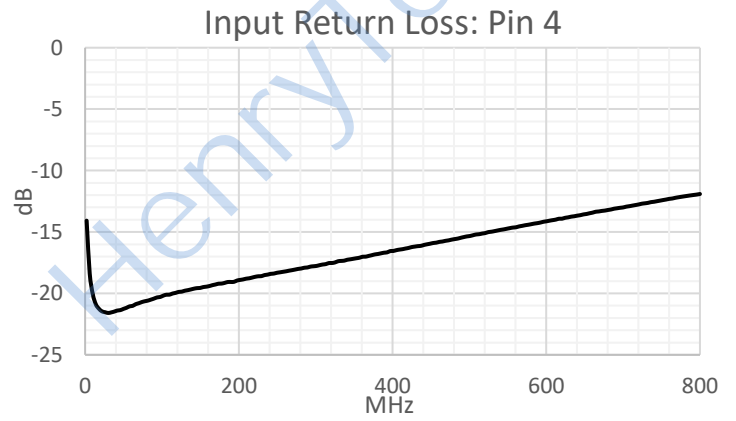
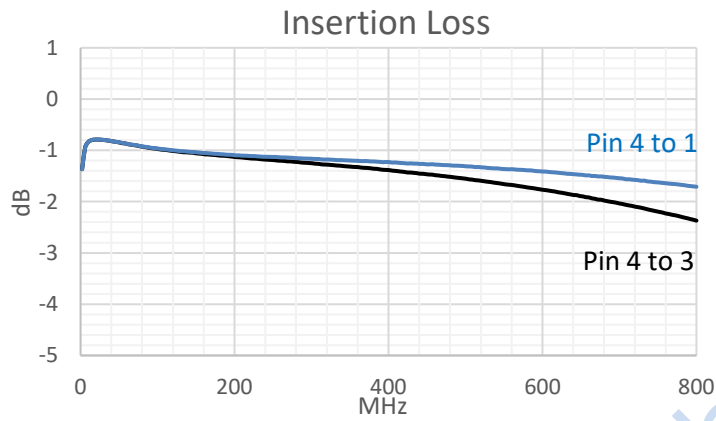

X-ON Electronics

Largest Supplier of Electrical and Electronic Components

Click to view similar products for [Signal Conditioning](#) category:

Click to view products by [HenryTech](#) manufacturer:

Other Similar products are found below :

[PD0409J5050S2HF](#) [HHS-109-PIN](#) [AFS14A35-1591.50-T3](#) [JP510S](#) [LFB322G45SN1A504](#) [SF2159E](#) [FM-104-PIN](#) [CER0813B](#)

[MAPDCC0005](#) [3A325](#) [BD0810N50100AHF](#) [DC0710J5005AHF](#) [DC2327J5005AHF](#) [LFL15869MTC1B787](#) [X3C19F1-20S](#)

[CDBLB455KCAX39-B0](#) [RF1353C](#) [051157-0000](#) [PD0922J5050D2HF](#) [600S150FTRB](#) [1E1305-3](#) [1F1304-3S](#) [TP-103-PIN](#)

[BD1222J50200AHF](#) [BD1722J50100AHF](#) [2450DP39K5400E](#) [BD0810J50150AHF](#) [BD1722J50200AHF](#) [DS-327-PIN](#) [MACP-008125-](#)

[CK07F0](#) [DS-329-PIN](#) [DS-313-PIN](#) [TP-104-PIN](#) [TP-101-PIN](#) [HH-128-PIN](#) [8594810000](#) [T-1000-N](#) [JP506S](#) [XC0900P-10S](#) [XC0900B-30S](#)

[CHE1260-QAG](#) [11305-10](#) [5962-9091202MXA](#) [3A412S](#) [X3C06A4-03S](#) [B39000Z3410A4](#) [DSS-333-PIN](#) [PD2425J5050S2HF](#)

[B39242B4360P810](#) [B39781B8005P810](#)