

## H3-MAPD-011007

5-2150MHz 75Ω 2 Way Power Divider

### APPLICATIONS

- Ideally suitable for CATV applications.

### FEATURES

- Surface mount
- 2 Way 0 degree
- 260°C reflow compatible
- RoHS compliant and Pb free
- Available on tape and reel

### DIMENSIONS

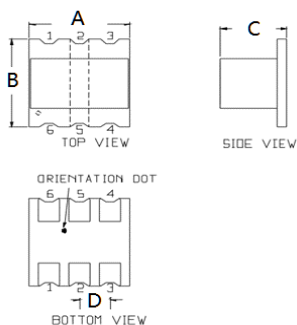

A	B	C
4.30	4.30	3.00
D		
1.27		

Unless otherwise stated dimensions are in mm

Tolerance: .xx ± 0.25, .xxx ± 0.05

### PCB LAYOUT

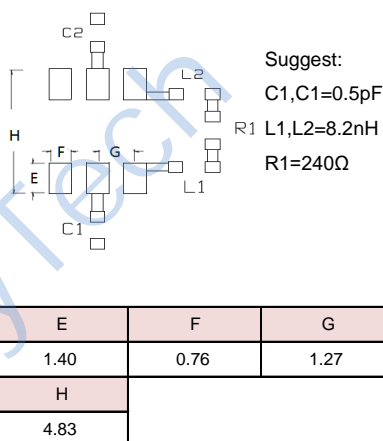

### FUNCTIONAL SCHEMATIC

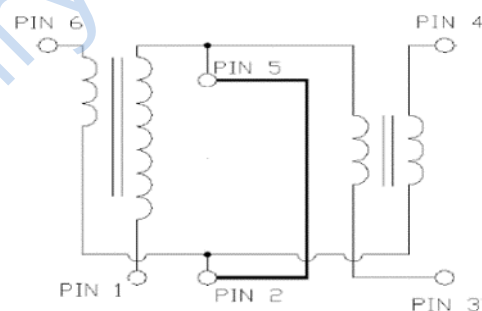

### PIN CONFIGURATION

Pin No.	Function
1	Ground
2	External 0.5 pF Capacitor
3	Output 2
4	Output 1
5	External 0.5 pF Capacitor
6	Input

### ELECTRICAL SPECIFICATIONS@25°C:

Parameters (P#: ENA PORT)	frequency band	Min.	Typ.	Max.	Unit
Port Impedance, Z0 (P1 / P2 / P3)			75 / 75 / 75		Ohm
Power Split			3		dB
Insertion Loss 1 (pin 6 - pin 4)	5-1002MHz		0.3	0.7	dB
	1003-1218MHz		0.5	1.0	dB
	1218-1600MHz		0.6	1.2	dB
	1600-2150MHz		1.0	2.0	dB
Insertion Loss 2 (pin 6 - pin 3)	5-1002MHz		0.6	1.0	dB
	1003-1218MHz		0.8	1.2	dB
	1218-1600MHz		1.1	1.6	dB
	1600-2150MHz		2.3	3.2	dB
Amplitude Balance	5-1002MHz		0.3	0.5	dB
	1003-1218MHz		0.3	0.5	dB
	1218-1600MHz		0.3	0.5	dB
	1600-2150MHz		0.8	1.5	dB
Phase Balance	5-1002MHz		0.8	4	Deg
	1003-1600MHz		1	6	Deg
	1600-2150MHz		1.2	7	Deg
Input Return Loss	5-1002MHz	20	39		dB
	1003-1600MHz	14	22		dB
	1600-2150MHz	11	18		dB
Output Return Loss (Pin4)	5-1002MHz	17	28		dB
	1003-1600MHz	13	18		dB
	1600-2150MHz	9	14		dB
Output Return Loss (Pin3)	5-1002MHz	20	40		dB
	1003-1600MHz	15	22		dB
	1600-2150MHz	12	18		dB
Isolation	5-10MHz	24	30		dB
	10-65 MHz	30	42		dB
	66-870 MHz	26	34		dB
	871-1002MHz	24	31		dB
	1003-1600MHz	22	31		dB
	1600-2150MHz	15	24		dB

### APPLICATION & TEST CIRCUIT

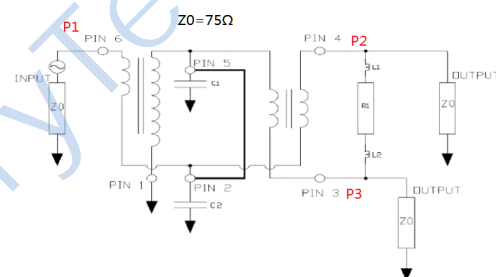

Suggest: C1,C1=0.5pF  
L1,L2=8.2nH  
R1=240Ω

### ABSOLUTE MAXIMUM RATINGS

Parameter	Value
Input RF Power	1W Max
Internal Load Dissipation	0.125W Max
Operating Temperature Range	-40 to 85°C

Tel: +86-28-85589664

E-mail: mr\_li@henglitaitech.com

Web: www.hltchips.com

Adress: No.198 Tianqin East Street, Gaoxin West District, Chengdu City

## TEST CURVE

Insertion Loss: Pin 6 to Pin 4

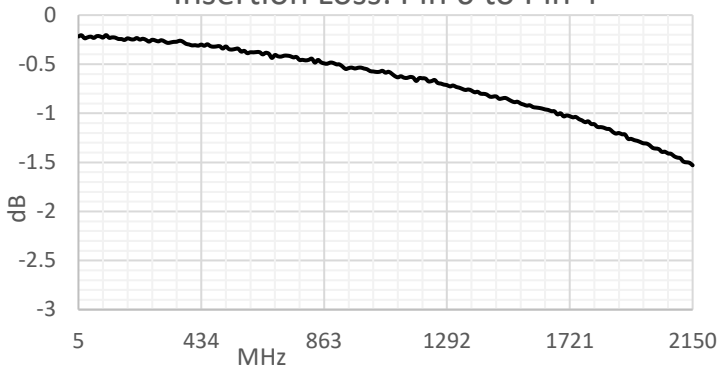

Insertion Loss: Pin 6 to Pin 3

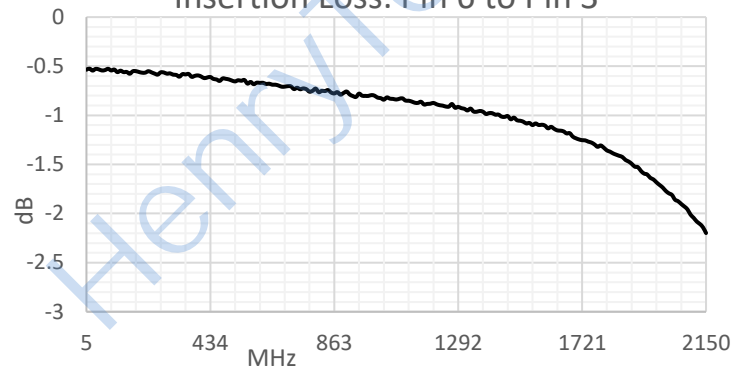

Input Return Loss: Pin 6

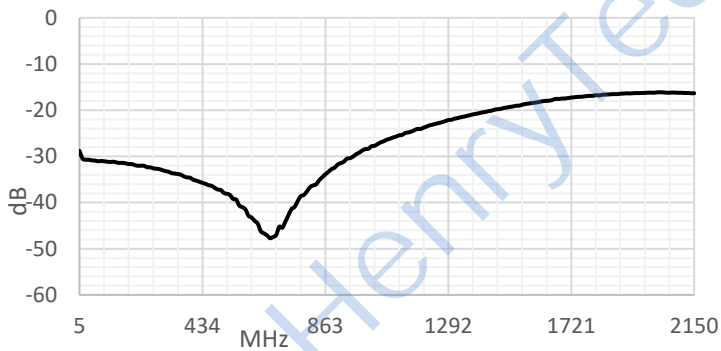

Output Return Loss: Pin 4

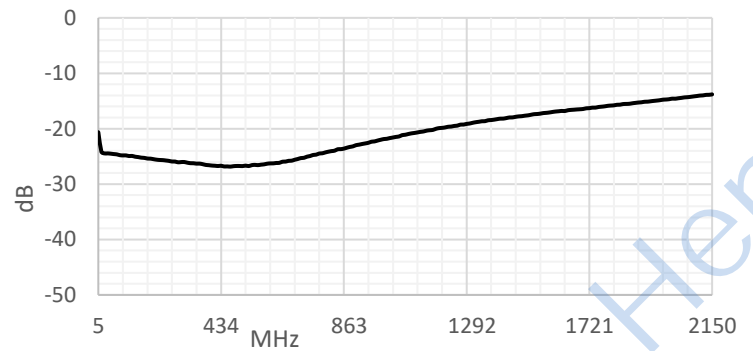

Output Return Loss: Pin 3

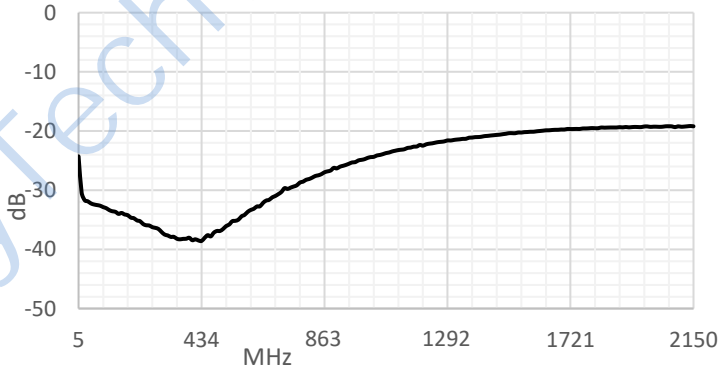

Isolation

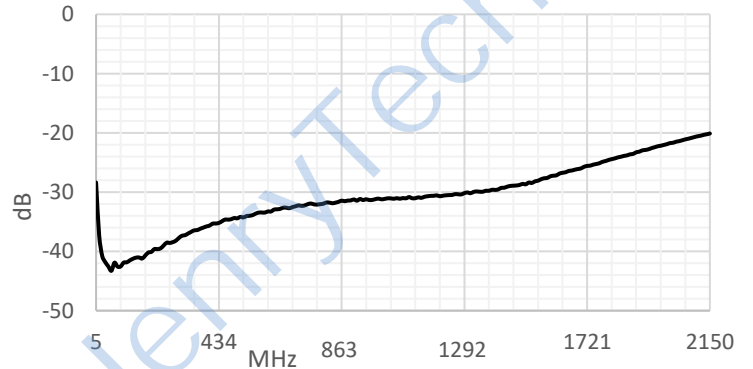

Amplitude Balance

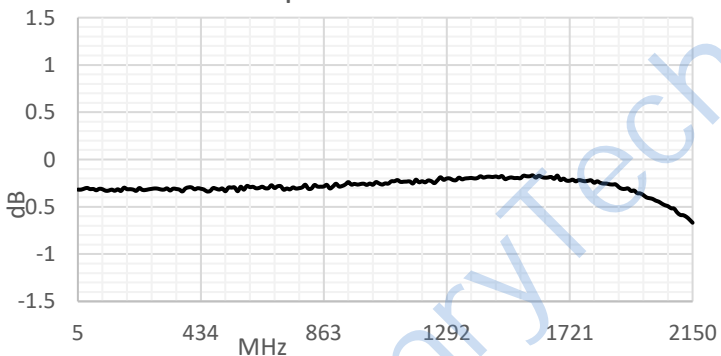

Phase Balance

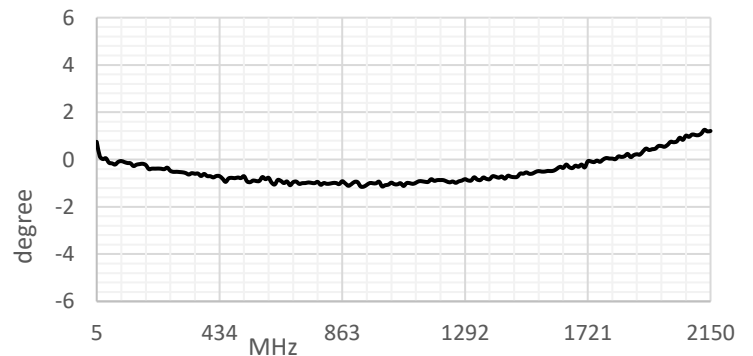

## X-ON Electronics

Largest Supplier of Electrical and Electronic Components

*Click to view similar products for [Signal Conditioning](#) category:*

*Click to view products by [HenryTech](#) manufacturer:*

Other Similar products are found below :

[PD0409J5050S2HF](#) [HHS-109-PIN](#) [AFS14A35-1591.50-T3](#) [JP510S](#) [LFB322G45SN1A504](#) [SF2159E](#) [FM-104-PIN](#) [CER0813B](#)  
[MAPDCC0005](#) [3A325](#) [BD0810N50100AHF](#) [DC0710J5005AHF](#) [DC2327J5005AHF](#) [LFL15869MTC1B787](#) [X3C19F1-20S](#)  
[CDBLB455KCAX39-B0](#) [RF1353C](#) [051157-0000](#) [PD0922J5050D2HF](#) [600S150FTRB](#) [1E1305-3](#) [1F1304-3S](#) [TP-103-PIN](#)  
[BD1222J50200AHF](#) [BD1722J50100AHF](#) [2450DP39K5400E](#) [BD0810J50150AHF](#) [BD1722J50200AHF](#) [DS-327-PIN](#) [MACP-008125-](#)  
[CK07F0](#) [DS-329-PIN](#) [DS-313-PIN](#) [TP-104-PIN](#) [TP-101-PIN](#) [HH-128-PIN](#) [8594810000](#) [T-1000-N](#) [JP506S](#) [XC0900P-10S](#) [XC0900B-30S](#)  
[CHE1260-QAG](#) [11305-10](#) [5962-9091202MXA](#) [3A412S](#) [X3C06A4-03S](#) [B39000Z3410A4](#) [DSS-333-PIN](#) [PD2425J5050S2HF](#)  
[B39242B4360P810](#) [B39781B8005P810](#)