

## H3-TCM1-63AX+

10-6000MHz 50Ω 1:1 Balun

### APPLICATIONS

- differential modulator/demodulator and active mixers
- wideband push-pull amplifiers
- LTE, Cellular, PCS, UMTS, WiFi, WiMAX

### FEATURES

- Surface mount
- Impedance ratio: 1:1
- RoHS compliant and Pb free
- Available on tape and reel

### DIMENSIONS

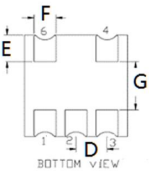
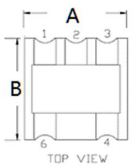

### Land Pattern

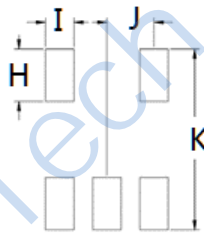

A	B	C	D	H	I	J
4.21	4.21	2.40	1.27	1.40	0.76	1.27
E	F	G	K			
1.11	0.90	2.00	4.83			

Unless otherwise stated dimensions are in mm

Tolerance: .xx ± 0.25, .xxx ± 0.05

### ELECTRICAL SPECIFICATIONS@25°C:

Parameters (P#: ENA PORT)	frequency band	Min.	Typ.	Max.	Unit
Port Impedance, Z0 (P1 / P2 / P3)			50 /25 25		Ohm
Insertion Loss	10-5000MHz		1.8	2.5	dB
	5000-6000MHz		2.4	3.0	dB
Amplitude Balance	10-6000MHz		0.5		dB
Phase Balance	10-6000MHz		8.0		Deg
Input Return Loss	10-6000MHz		13		dB

### TEST CURVE

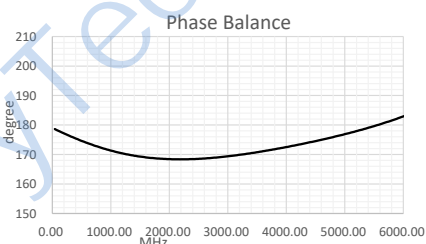
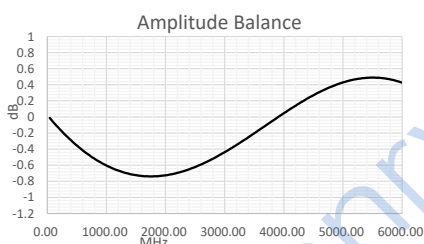
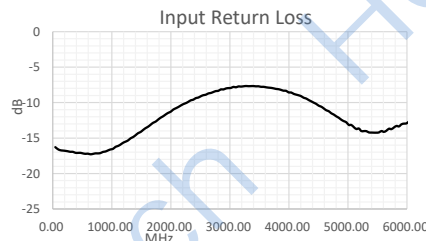

### FUNCTIONAL SCHEMATIC

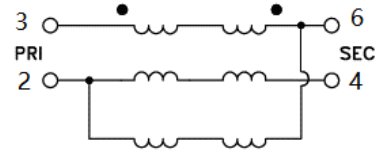

### PIN CONFIGURATION

Pin No.	Function
1	Not used
2	Primary
3	Primary Dot
4	Secondary
6	Secondary Dot

### APPLICATION & TEST CIRCUIT

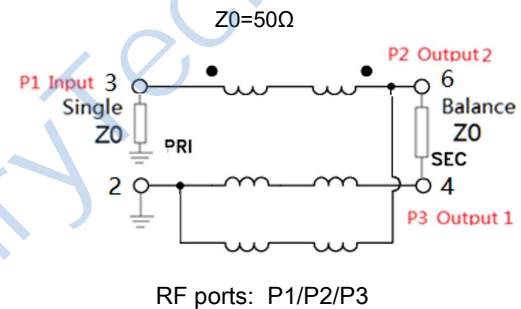

### ABSOLUTE MAXIMUM RATINGS

Parameter	Value
Input Power	200mW Max
DC Current	30mA Max
Operating Temperature Range	-40 to 85°C
Storage Temperature Range	-55 to 100°C

Tel: +86-28-85589664

E-mail: mr\_li@henglitaitech.com

Web: www.hltchips.com

Adress: No.198 Tianqin East Street, Gaoxin West District, Chengdu City

## X-ON Electronics

Largest Supplier of Electrical and Electronic Components

*Click to view similar products for [Signal Conditioning](#) category:*

*Click to view products by [HenryTech](#) manufacturer:*

Other Similar products are found below :

[PD0409J5050S2HF](#) [HHS-109-PIN](#) [AFS14A35-1591.50-T3](#) [JP510S](#) [LFB322G45SN1A504](#) [SF2159E](#) [FM-104-PIN](#) [CER0813B](#)  
[MAPDCC0005](#) [3A325](#) [BD0810N50100AHF](#) [DC0710J5005AHF](#) [DC2327J5005AHF](#) [LFL15869MTC1B787](#) [X3C19F1-20S](#)  
[CDBLB455KCAX39-B0](#) [RF1353C](#) [051157-0000](#) [PD0922J5050D2HF](#) [600S150FTRB](#) [1E1305-3](#) [1F1304-3S](#) [TP-103-PIN](#)  
[BD1222J50200AHF](#) [BD1722J50100AHF](#) [2450DP39K5400E](#) [BD0810J50150AHF](#) [BD1722J50200AHF](#) [DS-327-PIN](#) [MACP-008125-](#)  
[CK07F0](#) [DS-329-PIN](#) [DS-313-PIN](#) [TP-104-PIN](#) [TP-101-PIN](#) [HH-128-PIN](#) [8594810000](#) [T-1000-N](#) [JP506S](#) [XC0900P-10S](#) [XC0900B-30S](#)  
[CHE1260-QAG](#) [11305-10](#) [5962-9091202MXA](#) [3A412S](#) [X3C06A4-03S](#) [B39000Z3410A4](#) [DSS-333-PIN](#) [PD2425J5050S2HF](#)  
[B39242B4360P810](#) [B39781B8005P810](#)