

LOW DROPOUT POSITIVE VOLTAGE REGULATOR

DESCRIPTION

The LM1085 series of positive adjustable and fixed regulators are designed to provide 3A with high efficiency. All internal circuitry is designed to operate down to 1.3V input to output differential. On-chip trimming adjusts the reference voltage to 1%.

APPLICATIONS

- High Efficiency Linear Regulators
- Post Regulators for Switching Supplies
- Adjustable Power Supply

FEATURES

- Adjustable or Fixed Output
- Output Current of 3A
- Low Dropout, 1.5V max at 3A Output Current
- 0.04% Line Regulation
- 0.2 % Load Regulation
- 100% Thermal Limit Burn-In
- Fast Transient Response

TYPICAL APPLICATION DATA

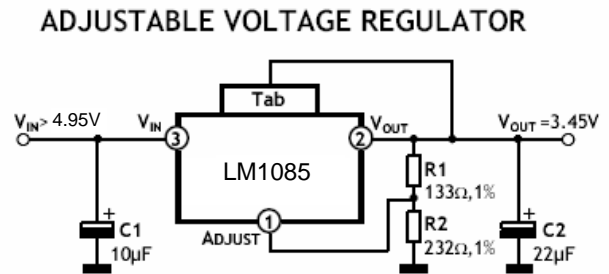
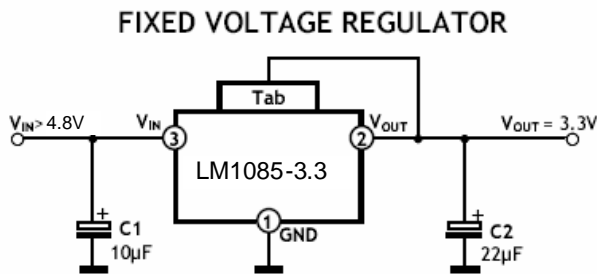

NOTES:

- C1 needed if device is far from filter capacitors
- C2 minimum value required for stability

$$V_{OUT} = V_{REF} \times \left(1 + \frac{R2}{R1}\right) + I_{ADJ} \times R2$$

PIN DESCRIPTION

	PIN NO.	FIXED VERSION	ADJUSTABLE VERSION	
		1	GROUND	
	2	V _{OUT}	V _{OUT}	
	3	V _{IN}	V _{IN}	
	Tab	V _{OUT}	V _{OUT}	

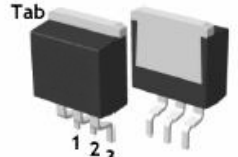
TO-220-3				TO-263-3
TO-252-2				TO-263-2

ABSOLUTE MAXIMUM RATINGS

SYMBOL	PARAMETER	VALUE	UNIT
V _{CC}	Power Dissipation	Internally Limited	W
V _{IN}	Input Voltage	15	V
T _J	Operation Junction Temperature Range		
	Control Section	-40 to 125	°C
	Power Transistor	-40 to 150	
T _{STG}	Storage Temperature Range	-65 to +150	°C
T _{LEAD}	Lead Temperature (Soldering 10 sec)	300	°C

ELECTRICAL CHARACTERISTICS

 I_{LOAD} = 0mA and T_J = +25 °C (unless otherwise noted)

PARAMETER	DEVICE	TEST CONDITIONS	MIN.	TYP.	MAX.	UNIT	
Reference Voltage Note 1	LM1085	V _{IN} = 5V, I _{LOAD} = 10mA	1.238	1.250	1.262	V	
		V _{IN} - V _{OUT} = 1.5V to 10V, I _{LOAD} = 10mA to 3A	*	1.225	1.250		1.275
Output Voltage Note 1	All fixed versions	V _{IN} - V _{OUT} = 1.5V, Variator from nominal V _{OUT}	-1	-	+1	%	
		V _{IN} - V _{OUT} = 1.5V to 10V, I _{LOAD} = 0mA to 3A, Variator from nominal V _{OUT}	*	-2	-		+2
Line Regulation Note 1	All	I _{LOAD} = 10mA, V _{IN} - V _{OUT} = 1.5V to 10V	*	-	0.04	0.20	%
Load Regulation Note 1	All	V _{IN} - V _{OUT} = 1.5V, I _{LOAD} = 10mA to 3A	*	-	0.2	0.40	
Minimum Load Current	LM1085	V _{IN} = 5V, V _{ADJ} = 0V	*	-	3	7	mA
Ground Pin Current	All fixed versions	V _{IN} - V _{OUT} = 1.5V, I _{LOAD} = 10mA to 3A	*	-	7	10	mA
Adjust Pin Current	LM1085	V _{IN} - V _{OUT} = 1.5V to 10V, I _{LOAD} = 10mA	*	-	40	90	µA
Current Limit	All	V _{IN} - V _{OUT} = 1.5V	*	3	4.5	-	A
Ripple Rejection Note 2	All	V _{IN} - V _{OUT} = 3V, I _{LOAD} = 3A	*	60	65	-	dB
Dropout Voltage Note 1,3	All	I _{LOAD} = 3A	*	-	1.3	1.5	V
Temperature Coefficient	All	V _{IN} - V _{OUT} = 1.5V, I _{LOAD} = 10mA	*	-	0.005	-	%/°C

 The * denotes the specifications which apply over the full temperature range (see previous table, T_J)

NOTES:

- 1: Low duty pulse testing with Kelvin connections required.
- 2: 120Hz input ripple (C_{ADJ} for ADJ = 25µF, C_{OUT} = 25µF)
- 3: ΔV_{OUT}, ΔV_{REF} = 1%

APPLICATION INFORMATION

The LM1085 series of adjustable and fixed regulators are easy to use and have all the protection features expected in high performance voltage regulators: short circuit protection and thermal shut-down.

Pin compatible with older three terminal adjustable regulators, these devices offer the advantage of a lower dropout voltage, more precise reference tolerance and improved reference stability with temperature.

STABILITY

The circuit design used in the LM1085 series requires the use of an output capacitor as part of the device frequency compensation.

The addition of 150µF aluminum electrolytic or a 22µF solid tantalum on the output will ensure stability for all operating conditions.

When the adjustment terminal is bypassed with a capacitor to improve the ripple rejection, the requirement

for an output capacitor increases. The value of 22 μ F tantalum or 150 μ F aluminum covers all cases of bypassing the adjustment terminal. Without bypassing the adjustment terminal smaller capacitors can be used with equally good results. To ensure good transient response with heavy load current changes capacitor values on the order of 100 μ F are used in the output of many regulators. To further improve stability and transient response of these devices larger values of output capacitor can be used.

PROTECTION DIODES

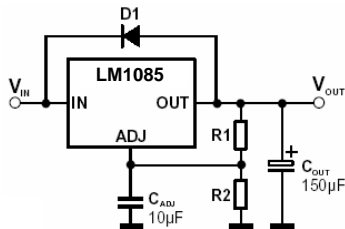

Unlike older regulators, the LM1085 family does not need any protection diodes between the adjustment pin and the output and from the output to the input to prevent over-stressing the die.

Internal resistors are limiting the internal current paths on the LM1085 adjustment pin, therefore even with capacitors on the adjustment pin no protection diode is needed to ensure device safety under short-circuit conditions.

Diodes between the input and output are not usually needed.

Microsecond surge currents of 50A to 100A can be handled by the internal diode between the input and output pins of the device. In normal operations it is difficult to get those values of surge currents even with the use of large output capacitances. If high value output capacitors are used, such as 1000 μ F to 5000 μ F and the input pin is instantaneously shorted to ground, damage can occur. A diode from output to input is recommended, when a crowbar circuit at the input of the LM1085 is used. Normal power supply cycling or even plugging and unplugging in the system will not generate current large enough to do any damage.

The adjustment pin can be driven on a transient basis ± 25 V, with respect to the output without any device degradation. As with any IC regulator, none the protection circuitry will be functional and the internal transistors will break down if the maximum input to output voltage differential is exceeded.

RIPPLE REJECTION

The ripple rejection values are measured with the adjustment pin bypassed. The impedance of the adjust pin capacitor at the ripple frequency should be less than the value of R1 (normally 100 Ω to 120 Ω) for a proper bypassing and ripple rejection approaching the values shown. The size of the required adjust pin capacitor is a function of the input ripple frequency. If R1=100 Ω at 120Hz the adjust pin capacitor should be 25 μ F. At 10 kHz only 0.22 μ F is needed.

The ripple rejection will be a function of output voltage, in circuits without an adjust pin bypass capacitor. The output ripple will increase directly as a ratio of the output voltage to the reference voltage (V_{OUT} / V_{REF}).

OUTPUT VOLTAGE

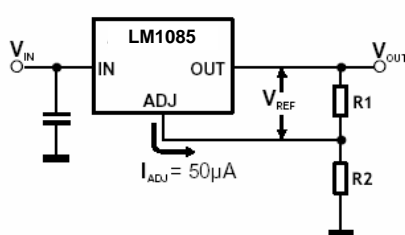

The LM1085 series develops a 1.25V reference voltage between the output and the adjust terminal. Placing a resistor between these two terminals causes a constant current to flow through R1 and down through R2 to set the overall output voltage.

This current is normally the specified minimum load current of 10mA. Because I_{ADJ} is very small and constant it represents a small error and it can usually be ignored.

LOAD REGULATION

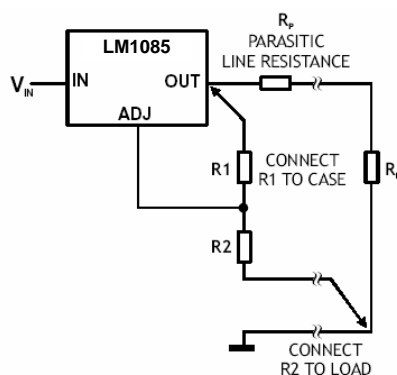

True remote load sensing it is not possible to provide, because the LM1085 is a three terminal device. The resistance of the wire connecting the regulator to the load will limit the load regulation.

The data sheet specification for load regulation is measured at the bottom of the package. Negative side sensing is a true Kelvin connection, with the bottom of the output divider returned to the negative side of the load.

The best load regulation is obtained when the top of the resistor divider R1 is connected directly to the case not to the load. If R1 were connected to the load, the effective resistance between the regulator and the load would be:

$$\frac{R_P \times (R_2 + R_1)}{R_1}, \quad R_P = \text{Parasitic Line Resistance}$$

Connected as shown Fig.3, R_p is not multiplied by the divider ratio. Using 16-gauge wire the parasitic line resistance is about 0.004Ω per foot, translating to 4mV/ft at 1A load current. It is important to keep the positive lead between regulator and load as short as possible and use large wire or PC board traces.

THERMAL CONSIDERATIONS

The LM1085 series have internal power and thermal limiting circuitry designed to protect the device under overload conditions. However maximum junction temperature ratings should not be exceeded under continuous normal load conditions.

Careful consideration must be given to all sources of thermal resistance from junction to ambient, including junction-to-case, case-to-heat sink interface and heat sink resistance itself. To ensure safe operating temperatures and reflect more accurately the device temperature, new thermal resistance specifications have been developed. Unlike older regulators with a single junction-to-case thermal resistance specification, the data section for these new regulators provides a separate thermal resistance and maximum junction temperature for both the Control Section and the Power Transistor. Calculations for both temperatures under certain conditions of ambient temperature and heat sink resistance and to ensure that both thermal limits are met.

Junction-to-case thermal resistance is specified from the IC junction to the bottom of the case directly below the die. This is the lowest resistance path for the heat flow. In order to ensure the best possible thermal flow from this area of the package to the heat sink proper mounting is required. Thermal compound at the case-to-heat sink interface is recommended. A thermally conductive spacer can be used, if the case of the device must be electrically isolated, but its added contribution to thermal resistance has to be considered.

Important statement:

Huaguan Semiconductor Co,Ltd. reserves the right to change the products and services provided without notice. Customers should obtain the latest relevant information before ordering, and verify the timeliness and accuracy of this information.

Customers are responsible for complying with safety standards and taking safety measures when using our products for system design and machine manufacturing to avoid potential risks that may result in personal injury or property damage.

Our products are not licensed for applications in life support, military, aerospace, etc., so we do not bear the consequences of the application of these products in these fields.

Our documentation is only permitted to be copied without any tampering with the content, so we do not accept any responsibility or liability for the altered documents.

X-ON Electronics

Largest Supplier of Electrical and Electronic Components

Click to view similar products for [LDO Voltage Regulators](#) category:

Click to view products by [HGSEMI](#) manufacturer:

Other Similar products are found below :

[M38D29FFHP#U1](#) [702103A](#) [717726C](#) [742457H](#) [MP20051DN-LF-Z](#) [R5F111PGGFB#30](#) [AP7363-SP-13](#) [NCP103AMX285TCG](#)
[NCV8664CST33T3G](#) [NCV8752AMX28TCG](#) [L9454](#) [AP7362-HA-7](#) [LX13043CLD](#) [TCR3DF185,LM\(CT](#) [TCR3DF24,LM\(CT](#)
[TCR3DF285,LM\(CT](#) [TCR3DF31,LM\(CT](#) [TCR3DF45,LM\(CT](#) [TLF4949EJ](#) [L9708](#) [L970813TR](#) [030014BB](#) [059985X](#) [EAN61387601](#)
[EAN61573601](#) [NCP121AMX173TCG](#) [NCP4687DH15T1G](#) [NCV8703MX30TCG](#) [701326R](#) [702087BB](#) [755078E](#) [TCR2EN28,LF\(S](#)
[LM1117DT-1.8/NO](#) [LT1086CM#TRPBF](#) [AZ1085S2-1.5TRE1](#) [MAX15101EWL+T](#) [NCV8170AXV250T2G](#) [SCD337BTG](#)
[TCR3DF27,LM\(CT](#) [TCR3DF19,LM\(CT](#) [TCR3DF125,LM\(CT](#) [TCR2EN18,LF\(S](#) [MAX15103EWL+T](#) [TS2937CZ-5.0 C0](#) [MAX8878EUK30-](#)
[T](#) [MAX663CPA](#) [NCV4269CPD50R2G](#) [NCV8716MT30TBG](#) [AZ1117IH-1.2TRG1](#) [MP2013GQ-P](#)