

# LM1575/LM2575/LM2575HV SIMPLE SWITCHER® 1A Step-Down Voltage Regulator

## General Description

The LM2575 series of regulators are monolithic integrated circuits that provide all the active functions for a step-down (buck) switching regulator, capable of driving a 1A load with excellent line and load regulation. These devices are available in fixed output voltages of 3.3V, 5V, 12V, 15V, and an adjustable output version.

Requiring a minimum number of external components, these regulators are simple to use and include internal frequency compensation and a fixed-frequency oscillator.

The LM2575 series offers a high-efficiency replacement for popular three-terminal linear regulators. It substantially reduces the size of the heat sink, and in many cases no heat sink is required.

A standard series of inductors optimized for use with the LM2575 are available from several different manufacturers. This feature greatly simplifies the design of switch-mode power supplies.

Other features include a guaranteed  $\pm 4\%$  tolerance on output voltage within specified input voltages and output load conditions, and  $\pm 10\%$  on the oscillator frequency. External shutdown is included, featuring 50  $\mu\text{A}$  (typical) standby current.

## Features

- 3.3V, 5V, 12V, 15V, and adjustable output versions
- Adjustable version output voltage range, 1.23V to 37V (57V for HV version)  $\pm 4\%$  max over line and load conditions
- Guaranteed 1A output current
- Wide input voltage range, 40V up to 60V for HV version
- Requires only 4 external components
- 52 kHz fixed frequency internal oscillator
- TTL shutdown capability, low power standby mode
- High efficiency
- Uses readily available standard inductors
- Thermal shutdown and current limit protection
- P+ Product Enhancement tested

## Applications

- Simple high-efficiency step-down (buck) regulator
- Efficient pre-regulator for linear regulators
- On-card switching regulators
- Positive to negative converter (Buck-Boost)

## Typical Application (Fixed Output Voltage Versions)

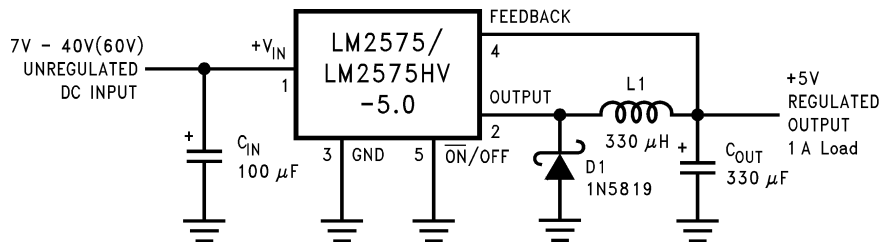

## Block Diagram and Typical Application

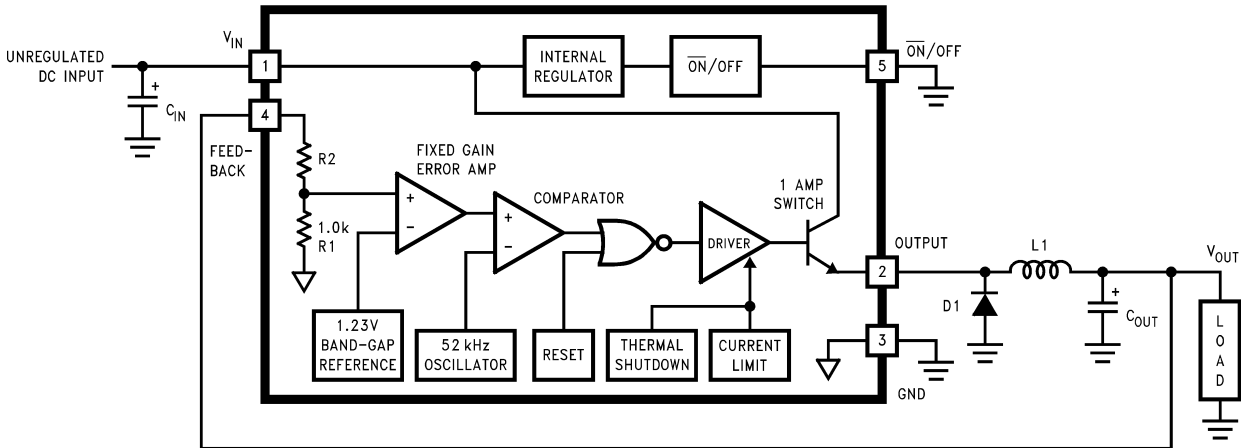

3.3V, R2 = 1.7k  
 5V, R2 = 3.1k  
 12V, R2 = 8.84k  
 15V, R2 = 11.3k  
 For ADJ. Version  
 R1 = Open, R2 = 0Ω

**Note:** Pin numbers are for the TO-220 package.

FIGURE 1.

## Connection Diagrams (XX indicates output voltage option.)

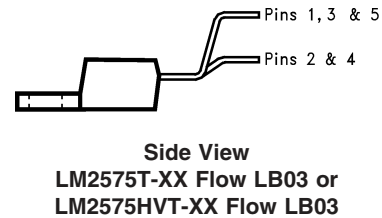
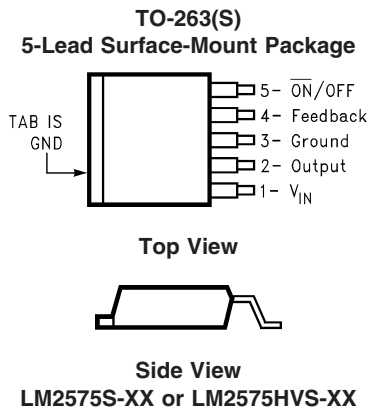
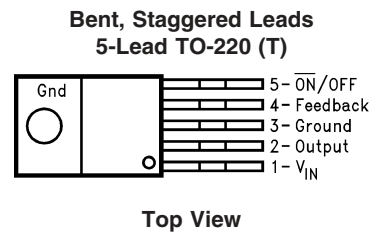
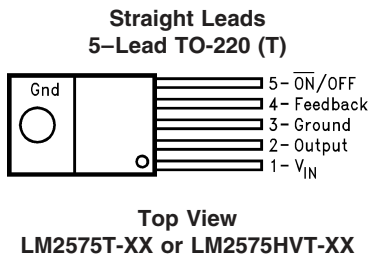

### Absolute Maximum Ratings (Note 1)

Maximum Supply Voltage		
LM1575/LM2575	45V	
LM2575HV	63V	
$\overline{ON}$ /OFF Pin Input Voltage	$-0.3V \leq V \leq +V_{IN}$	
Output Voltage to Ground (Steady State)	-1V	
Power Dissipation	Internally Limited	
Storage Temperature Range	$-65^{\circ}C$ to $+150^{\circ}C$	
Maximum Junction Temperature	$150^{\circ}C$	
Minimum ESD Rating (C = 100 pF, R = 1.5 k $\Omega$ )	2 kV	

Lead Temperature (Soldering, 10 sec.)	$260^{\circ}C$
--	----------------

### Operating Ratings

Temperature Range	
LM1575	$-55^{\circ}C \leq T_J \leq +150^{\circ}C$
LM2575/LM2575HV	$-40^{\circ}C \leq T_J \leq +125^{\circ}C$
Supply Voltage	
LM1575/LM2575	40V
LM2575HV	60V

### LM1575-3.3, LM2575-3.3, LM2575HV-3.3 Electrical Characteristics

Specifications with standard type face are for  $T_J = 25^{\circ}C$ , and those with **boldface type** apply over full Operating Temperature Range .

Symbol	Parameter	Conditions	Typ	LM1575-3.3	LM2575-3.3 LM2575HV-3.3	Units (Limits)
				Limit (Note 2)	Limit (Note 3)	
<b>SYSTEM PARAMETERS</b> (Note 4) Test Circuit <i>Figure 2</i>						
$V_{OUT}$	Output Voltage	$V_{IN} = 12V, I_{LOAD} = 0.2A$ Circuit of <i>Figure 2</i>	3.3	3.267 3.333	3.234 3.366	V V(Min) V(Max)
$V_{OUT}$	Output Voltage LM1575/LM2575	$4.75V \leq V_{IN} \leq 40V, 0.2A \leq I_{LOAD} \leq 1A$ Circuit of <i>Figure 2</i>	3.3	3.200/ <b>3.168</b> 3.400/ <b>3.432</b>	3.168/ <b>3.135</b> 3.432/ <b>3.465</b>	V V(Min) V(Max)
$V_{OUT}$	Output Voltage LM2575HV	$4.75V \leq V_{IN} \leq 60V, 0.2A \leq I_{LOAD} \leq 1A$ Circuit of <i>Figure 2</i>	3.3	3.200/ <b>3.168</b> 3.416/ <b>3.450</b>	3.168/ <b>3.135</b> 3.450/ <b>3.482</b>	V V(Min) V(Max)
$\eta$	Efficiency	$V_{IN} = 12V, I_{LOAD} = 1A$	75			%

### LM1575-5.0, LM2575-5.0, LM2575HV-5.0 Electrical Characteristics

Specifications with standard type face are for  $T_J = 25^{\circ}C$ , and those with **boldface type** apply over full Operating Temperature Range .

Symbol	Parameter	Conditions	Typ	LM1575-5.0	LM2575-5.0 LM2575HV-5.0	Units (Limits)
				Limit (Note 2)	Limit (Note 3)	
<b>SYSTEM PARAMETERS</b> (Note 4) Test Circuit <i>Figure 2</i>						
$V_{OUT}$	Output Voltage	$V_{IN} = 12V, I_{LOAD} = 0.2A$ Circuit of <i>Figure 2</i>	5.0	4.950 5.050	4.900 5.100	V V(Min) V(Max)
$V_{OUT}$	Output Voltage LM1575/LM2575	$0.2A \leq I_{LOAD} \leq 1A,$ $8V \leq V_{IN} \leq 40V$ Circuit of <i>Figure 2</i>	5.0	4.850/ <b>4.800</b> 5.150/ <b>5.200</b>	4.800/ <b>4.750</b> 5.200/ <b>5.250</b>	V V(Min) V(Max)
$V_{OUT}$	Output Voltage LM2575HV	$0.2A \leq I_{LOAD} \leq 1A,$ $8V \leq V_{IN} \leq 60V$ Circuit of <i>Figure 2</i>	5.0	4.850/ <b>4.800</b> 5.175/ <b>5.225</b>	4.800/ <b>4.750</b> 5.225/ <b>5.275</b>	V V(Min) V(Max)

### LM1575-5.0, LM2575-5.0, LM2575HV-5.0

#### Electrical Characteristics (Continued)

Specifications with standard type face are for  $T_J = 25^\circ\text{C}$ , and those with **boldface type** apply over full Operating Temperature Range.

Symbol	Parameter	Conditions	Typ	LM1575-5.0	LM2575-5.0 LM2575HV-5.0	Units (Limits)
				Limit (Note 2)	Limit (Note 3)	
$\eta$	Efficiency	$V_{IN} = 12\text{V}$ , $I_{LOAD} = 1\text{A}$	77			%

### LM1575-12, LM2575-12, LM2575HV-12

#### Electrical Characteristics

Specifications with standard type face are for  $T_J = 25^\circ\text{C}$ , and those with **boldface type** apply over full Operating Temperature Range .

Symbol	Parameter	Conditions	Typ	LM1575-12	LM2575-12 LM2575HV-12	Units (Limits)
				Limit (Note 2)	Limit (Note 3)	
<b>SYSTEM PARAMETERS</b> (Note 4) Test Circuit <i>Figure 2</i>						
$V_{OUT}$	Output Voltage	$V_{IN} = 25\text{V}$ , $I_{LOAD} = 0.2\text{A}$ Circuit of <i>Figure 2</i>	12	11.88 12.12	11.76 12.24	V V(Min) V(Max)
$V_{OUT}$	Output Voltage LM1575/LM2575	$0.2\text{A} \leq I_{LOAD} \leq 1\text{A}$ , $15\text{V} \leq V_{IN} \leq 40\text{V}$ Circuit of <i>Figure 2</i>	12	11.64/ <b>11.52</b> 12.36/ <b>12.48</b>	11.52/ <b>11.40</b> 12.48/ <b>12.60</b>	V V(Min) V(Max)
$V_{OUT}$	Output Voltage LM2575HV	$0.2\text{A} \leq I_{LOAD} \leq 1\text{A}$ , $15\text{V} \leq V_{IN} \leq 60\text{V}$ Circuit of <i>Figure 2</i>	12	11.64/ <b>11.52</b> 12.42/ <b>12.54</b>	11.52/ <b>11.40</b> 12.54/ <b>12.66</b>	V V(Min) V(Max)
$\eta$	Efficiency	$V_{IN} = 15\text{V}$ , $I_{LOAD} = 1\text{A}$	88			%

### LM1575-15, LM2575-15, LM2575HV-15

#### Electrical Characteristics

Specifications with standard type face are for  $T_J = 25^\circ\text{C}$ , and those with **boldface type** apply over full Operating Temperature Range .

Symbol	Parameter	Conditions	Typ	LM1575-15	LM2575-15 LM2575HV-15	Units (Limits)
				Limit (Note 2)	Limit (Note 3)	
<b>SYSTEM PARAMETERS</b> (Note 4) Test Circuit <i>Figure 2</i>						
$V_{OUT}$	Output Voltage	$V_{IN} = 30\text{V}$ , $I_{LOAD} = 0.2\text{A}$ Circuit of <i>Figure 2</i>	15	14.85 15.15	14.70 15.30	V V(Min) V(Max)
$V_{OUT}$	Output Voltage LM1575/LM2575	$0.2\text{A} \leq I_{LOAD} \leq 1\text{A}$ , $18\text{V} \leq V_{IN} \leq 40\text{V}$ Circuit of <i>Figure 2</i>	15	14.55/ <b>14.40</b> 15.45/ <b>15.60</b>	14.40/ <b>14.25</b> 15.60/ <b>15.75</b>	V V(Min) V(Max)
$V_{OUT}$	Output Voltage LM2575HV	$0.2\text{A} \leq I_{LOAD} \leq 1\text{A}$ , $18\text{V} \leq V_{IN} \leq 60\text{V}$ Circuit of <i>Figure 2</i>	15	14.55/ <b>14.40</b> 15.525/ <b>15.675</b>	14.40/ <b>14.25</b> 15.68/ <b>15.83</b>	V V(Min) V(Max)
$\eta$	Efficiency	$V_{IN} = 18\text{V}$ , $I_{LOAD} = 1\text{A}$	88			%

**LM1575-ADJ, LM2575-ADJ, LM2575HV-ADJ**  
**Electrical Characteristics**

 Specifications with standard type face are for  $T_J = 25^\circ\text{C}$ , and those with **boldface type** apply over **full Operating Temperature Range**.

Symbol	Parameter	Conditions	Typ	LM1575-ADJ	LM2575-ADJ LM2575HV-ADJ	Units (Limits)
				Limit (Note 2)	Limit (Note 3)	
<b>SYSTEM PARAMETERS</b> (Note 4) Test Circuit <i>Figure 2</i>						
$V_{OUT}$	Feedback Voltage	$V_{IN} = 12\text{V}$ , $I_{LOAD} = 0.2\text{A}$ $V_{OUT} = 5\text{V}$ Circuit of <i>Figure 2</i>	1.230	1.217 1.243	1.217 1.243	V V(Min) V(Max)
$V_{OUT}$	Feedback Voltage LM1575/LM2575	$0.2\text{A} \leq I_{LOAD} \leq 1\text{A}$ , $8\text{V} \leq V_{IN} \leq 40\text{V}$ $V_{OUT} = 5\text{V}$ , Circuit of <i>Figure 2</i>	1.230	1.205/ <b>1.193</b> 1.255/ <b>1.267</b>	1.193/ <b>1.180</b> 1.267/ <b>1.280</b>	V V(Min) V(Max)
$V_{OUT}$	Feedback Voltage LM2575HV	$0.2\text{A} \leq I_{LOAD} \leq 1\text{A}$ , $8\text{V} \leq V_{IN} \leq 60\text{V}$ $V_{OUT} = 5\text{V}$ , Circuit of <i>Figure 2</i>	1.230	1.205/ <b>1.193</b> 1.261/ <b>1.273</b>	1.193/ <b>1.180</b> 1.273/ <b>1.286</b>	V V(Min) V(Max)
$\eta$	Efficiency	$V_{IN} = 12\text{V}$ , $I_{LOAD} = 1\text{A}$ , $V_{OUT} = 5\text{V}$	77			%

**All Output Voltage Versions**  
**Electrical Characteristics**

 Specifications with standard type face are for  $T_J = 25^\circ\text{C}$ , and those with **boldface type** apply over **full Operating Temperature Range**. Unless otherwise specified,  $V_{IN} = 12\text{V}$  for the 3.3V, 5V, and Adjustable version,  $V_{IN} = 25\text{V}$  for the 12V version, and  $V_{IN} = 30\text{V}$  for the 15V version.  $I_{LOAD} = 200\text{mA}$ .

Symbol	Parameter	Conditions	Typ	LM1575-XX	LM2575-XX LM2575HV-XX	Units (Limits)
				Limit (Note 2)	Limit (Note 3)	
<b>DEVICE PARAMETERS</b>						
$I_b$	Feedback Bias Current	$V_{OUT} = 5\text{V}$ (Adjustable Version Only)	50	100/ <b>500</b>	100/ <b>500</b>	nA
$f_O$	Oscillator Frequency	(Note 13)	52	47/ <b>43</b> 58/ <b>62</b>	47/ <b>42</b> 58/ <b>63</b>	kHz kHz(Min) kHz(Max)
$V_{SAT}$	Saturation Voltage	$I_{OUT} = 1\text{A}$ (Note 5)	0.9	1.2/ <b>1.4</b>	1.2/ <b>1.4</b>	V V(Max)
DC	Max Duty Cycle (ON)	(Note 6)	98	93	93	% %(Min)
$I_{CL}$	Current Limit	Peak Current (Notes 5, 13)	2.2	1.7/ <b>1.3</b> 3.0/ <b>3.2</b>	1.7/ <b>1.3</b> 3.0/ <b>3.2</b>	A A(Min) A(Max)
$I_L$	Output Leakage Current	(Notes 7, 8) Output = 0V Output = -1V Output = -1V	7.5	2 30	2 30	mA(Max) mA mA(Max)
$I_Q$	Quiescent Current	(Note 7)	5	10/ <b>12</b>	10	mA mA(Max)
$I_{STBY}$	Standby Quiescent Current	$\overline{ON}$ /OFF Pin = 5V (OFF)	50	200/ <b>500</b>	200	$\mu\text{A}$ $\mu\text{A}$ (Max)

## All Output Voltage Versions Electrical Characteristics (Continued)

Specifications with standard type face are for  $T_J = 25^\circ\text{C}$ , and those with **boldface type** apply over **full Operating Temperature Range**. Unless otherwise specified,  $V_{IN} = 12\text{V}$  for the 3.3V, 5V, and Adjustable version,  $V_{IN} = 25\text{V}$  for the 12V version, and  $V_{IN} = 30\text{V}$  for the 15V version.  $I_{LOAD} = 200\text{mA}$ .

Symbol	Parameter	Conditions	Typ	LM1575-XX	LM2575-XX LM2575HV-XX	Units (Limits)
				Limit (Note 2)	Limit (Note 3)	
<b>DEVICE PARAMETERS</b>						
$\theta_{JA}$	Thermal Resistance	T Package, Junction to Ambient (Note 9)	65			$^\circ\text{C/W}$
$\theta_{JA}$		T Package, Junction to Ambient (Note 10)	45			
$\theta_{JC}$		T Package, Junction to Case	2			
$\theta_{JA}$		N Package, Junction to Ambient (Note 11)	85			
$\theta_{JA}$		M Package, Junction to Ambient (Note 11)	100			
$\theta_{JA}$		S Package, Junction to Ambient (Note 12)	37			
<b>ON /OFF CONTROL Test Circuit</b> <i>Figure 2</i>						
$V_{IH}$	$\overline{\text{ON}}$ /OFF Pin Logic	$V_{OUT} = 0\text{V}$	1.4	2.2/2.4	2.2/2.4	V(Min)
$V_{IL}$	Input Level	$V_{OUT} = \text{Nominal Output Voltage}$	1.2	1.0/0.8	1.0/0.8	V(Max)
$I_{IH}$	$\overline{\text{ON}}$ /OFF Pin Input Current	$\overline{\text{ON}}$ /OFF Pin = 5V (OFF)	12	30	30	$\mu\text{A}$ $\mu\text{A}(\text{Max})$
		$\overline{\text{ON}}$ /OFF Pin = 0V (ON)	0	10	10	$\mu\text{A}$ $\mu\text{A}(\text{Max})$

**Note 1:** Absolute Maximum Ratings indicate limits beyond which damage to the device may occur. Operating Ratings indicate conditions for which the device is intended to be functional, but do not guarantee specific performance limits. For guaranteed specifications and test conditions, see the Electrical Characteristics.

**Note 2:** All limits guaranteed at room temperature (standard type face) and at **temperature extremes (bold type face)**. All limits are used to calculate Average Outgoing Quality Level, and all are 100% production tested.

**Note 3:** All limits guaranteed at room temperature (standard type face) and at **temperature extremes (bold type face)**. All room temperature limits are 100% production tested. All limits at **temperature extremes** are guaranteed via correlation using standard Statistical Quality Control (SQC) methods.

**Note 4:** External components such as the catch diode, inductor, input and output capacitors can affect switching regulator system performance. When the LM1575/LM2575 is used as shown in the *Figure 2* test circuit, system performance will be as shown in system parameters section of Electrical Characteristics.

**Note 5:** Output (pin 2) sourcing current. No diode, inductor or capacitor connected to output pin.

**Note 6:** Feedback (pin 4) removed from output and connected to 0V.

**Note 7:** Feedback (pin 4) removed from output and connected to +12V for the Adjustable, 3.3V, and 5V versions, and +25V for the 12V and 15V versions, to force the output transistor OFF.

**Note 8:**  $V_{IN} = 40\text{V}$  (60V for the high voltage version).

**Note 9:** Junction to ambient thermal resistance (no external heat sink) for the 5 lead TO-220 package mounted vertically, with  $\frac{1}{2}$  inch leads in a socket, or on a PC board with minimum copper area.

**Note 10:** Junction to ambient thermal resistance (no external heat sink) for the 5 lead TO-220 package mounted vertically, with  $\frac{1}{2}$  inch leads soldered to a PC board containing approximately 4 square inches of copper area surrounding the leads.

**Note 11:** Junction to ambient thermal resistance with approximately 1 square inch of pc board copper surrounding the leads. Additional copper area will lower thermal resistance further. See thermal model in Switchers made Simple software.

**Note 12:** If the TO-263 package is used, the thermal resistance can be reduced by increasing the PC board copper area thermally connected to the package: Using 0.5 square inches of copper area,  $\theta_{JA}$  is  $50^\circ\text{C/W}$ ; with 1 square inch of copper area,  $\theta_{JA}$  is  $37^\circ\text{C/W}$ ; and with 1.6 or more square inches of copper area,  $\theta_{JA}$  is  $32^\circ\text{C/W}$ .

**Note 13:** The oscillator frequency reduces to approximately 18 kHz in the event of an output short or an overload which causes the regulated output voltage to drop approximately 40% from the nominal output voltage. This self protection feature lowers the average power dissipation of the IC by lowering the minimum duty cycle from 5% down to approximately 2%.

Typical Performance Characteristics (Circuit of Figure 2)

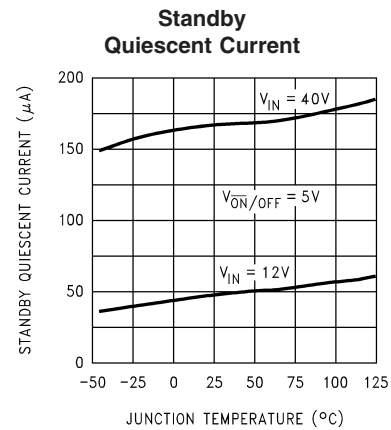
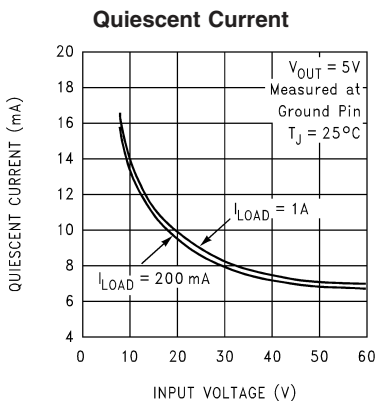
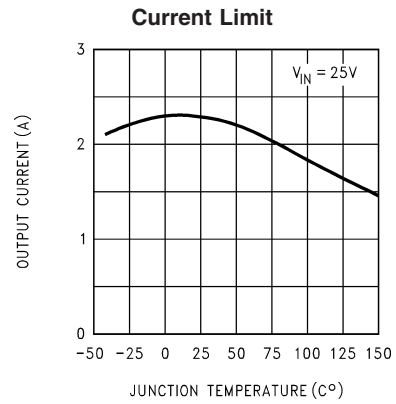
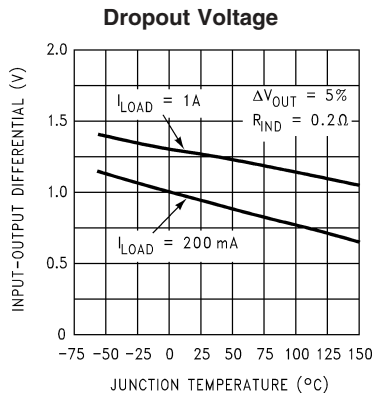
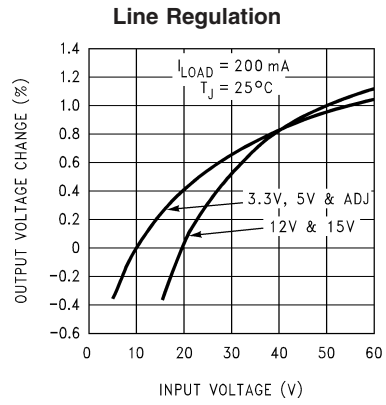
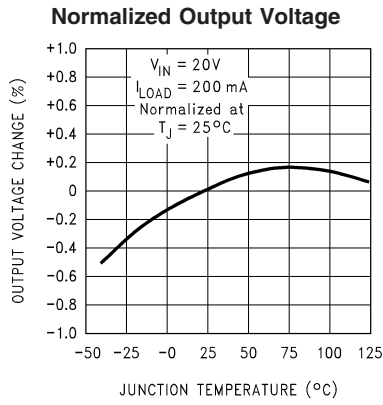

Typical Performance Characteristics (Circuit of Figure 2) (Continued)

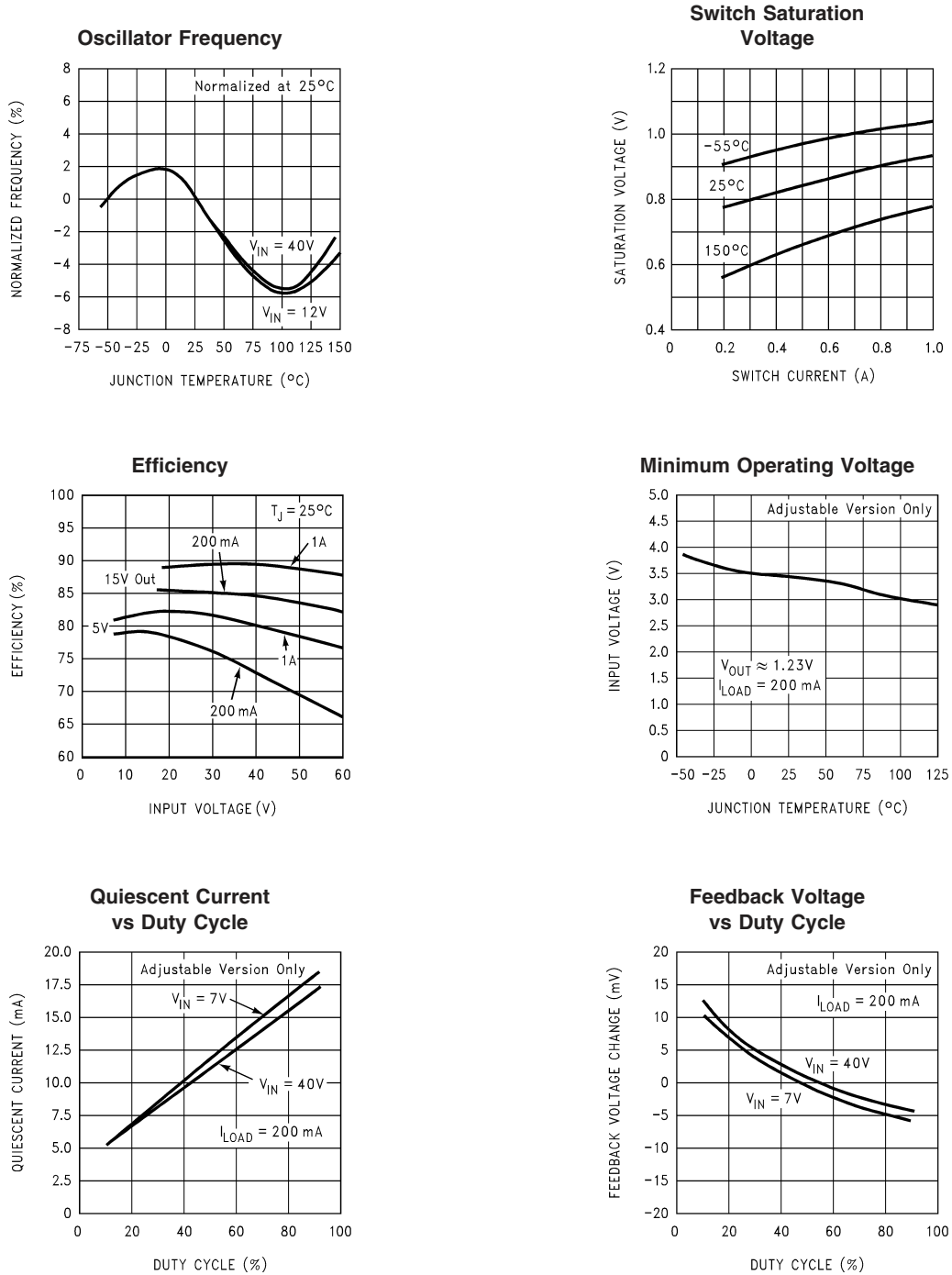



**Typical Performance Characteristics** (Circuit of Figure 2) (Continued)

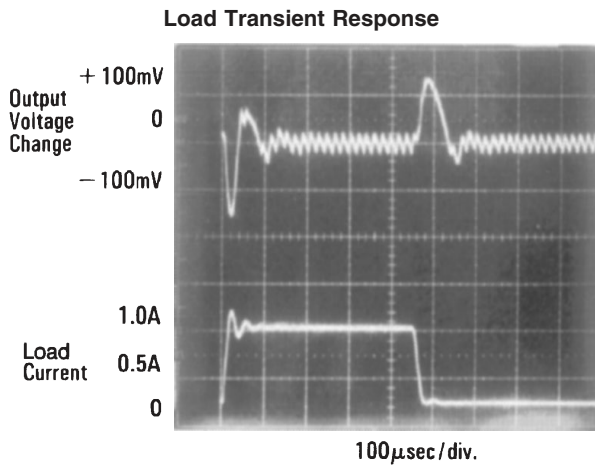
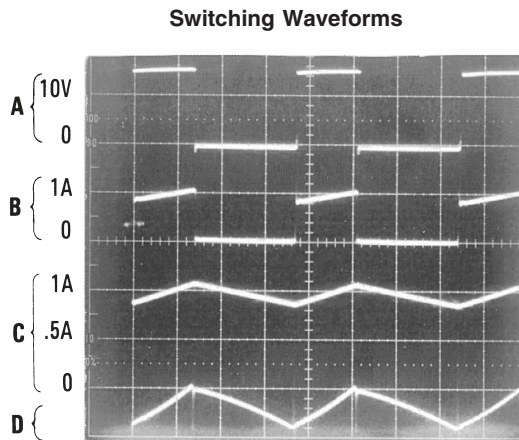
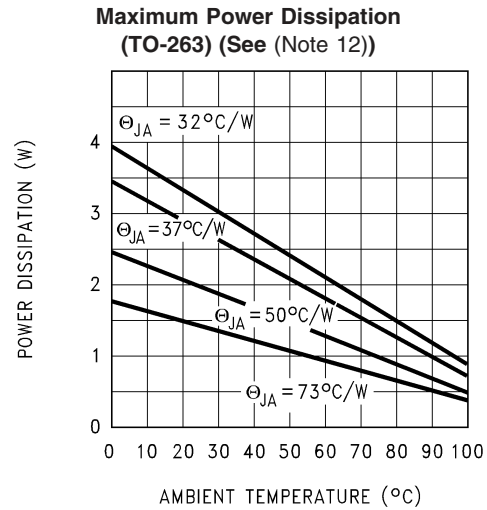
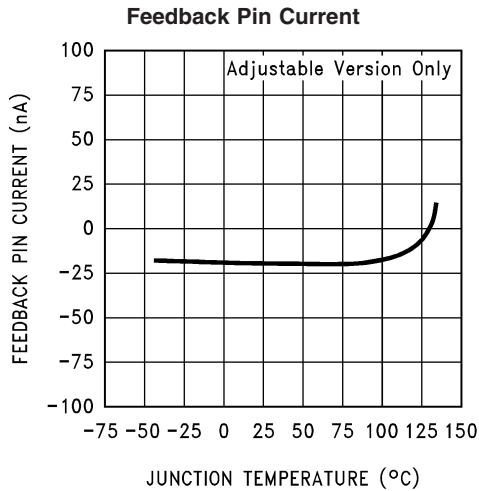

$V_{OUT} = 5V$

A: Output Pin Voltage, 10V/div

B: Output Pin Current, 1A/div

C: Inductor Current, 0.5A/div

D: Output Ripple Voltage, 20 mV/div,

AC-Coupled

Horizontal Time Base: 5 μs/div

**Test Circuit and Layout Guidelines**

As in any switching regulator, layout is very important. Rapidly switching currents associated with wiring inductance generate voltage transients which can cause problems. For minimal inductance and ground loops, the length of the leads indicated by heavy lines should be kept as short as possible.

Single-point grounding (as indicated) or ground plane construction should be used for best results. When using the Adjustable version, physically locate the programming resistors near the regulator, to keep the sensitive feedback wiring short.

Test Circuit and Layout Guidelines (Continued)

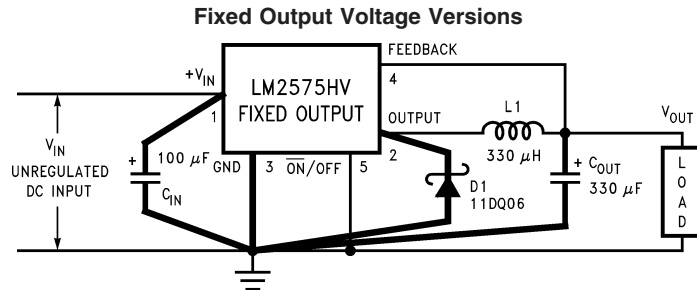

$C_{IN}$  — 100  $\mu$ F, 75V, Aluminum Electrolytic

$C_{OUT}$  — 330  $\mu$ F, 25V, Aluminum Electrolytic

D1 — Schottky, 11DQ06

L1 — 330  $\mu$ H, PE-52627 (for 5V in, 3.3V out, use 100  $\mu$ H, PE-92108)

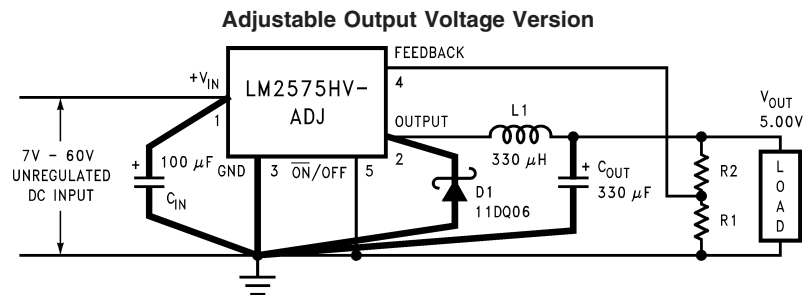

$$V_{OUT} = V_{REF} \left( 1 + \frac{R2}{R1} \right)$$

$$R2 = R1 \left( \frac{V_{OUT}}{V_{REF}} - 1 \right)$$

where  $V_{REF} = 1.23V$ , R1 between 1k and 5k.

R1 — 2k, 0.1%

R2 — 6.12k, 0.1%

FIGURE 2.

## X-ON Electronics

Largest Supplier of Electrical and Electronic Components

*Click to view similar products for [Isolated DC/DC Converters](#) category:*

*Click to view products by [HGSEMI](#) manufacturer:*

Other Similar products are found below :

[ESM6D044440C05AAQ](#) [FMD15.24G](#) [PSL486-7LR](#) [PSR152.5-7IR](#) [Q48T30020-NBB0](#) [AVO240-48S12B-6L](#) [AVO250-48S28B-6L](#) [NAN-0505](#) [HW-L16D](#) [JAHW100Y1](#) [217-1617-001](#) [22827](#) [SPB05C-12](#) [SQ24S15033-PS0S](#) [18952](#) [19-130041](#) [CE-1003](#) [CE-1004](#) [GQ2541-7R](#) [PSE1000DCDC-12V](#) [RDS180245](#) [MAU228](#) [419-2065-201](#) [449-2075-101](#) [TME 0303S](#) [TME 0505S](#) [TME 1205S](#) [TME 1212S](#) [TME 2405S](#) [TME 2412S](#) [J80-0041NL](#) [V300C24C150BG](#) [419-2062-200](#) [419-2063-401](#) [419-2067-101](#) [419-2067-501](#) [419-2068-001](#) [DCG40-5G](#) [DFC15U48D15](#) [449-2067-000](#) [XGS-0512](#) [XGS-1205](#) [XGS-1212](#) [XGS-2412](#) [XGS-2415](#) [XKS-1215](#) [033456](#) [NCT1000N040R050B](#) [SPB05B-15](#) [SPB05C-15](#)