

SIMPLE SWITCHER® Power Converter 150 kHz 2A Step-Down Voltage Regulator

General Description

The LM2592HV series of regulators are monolithic integrated circuits that provide all the active functions for a step-down (buck) switching regulator, capable of driving a 2A load with excellent line and load regulation. These devices are available in fixed output voltages of 3.3V, 5V, and an adjustable output version.

This series of switching regulators is similar to the LM2593HV, but without some of the supervisory and performance features of the latter.

Requiring a minimum number of external components, these regulators are simple to use and include internal frequency compensation†, improved line and load specifications and a fixed-frequency oscillator.

The LM2592HV operates at a switching frequency of 150 kHz thus allowing smaller sized filter components than what would be needed with lower frequency switching regulators. Available in a standard 5-lead TO-220 package with several different lead bend options, and a 5-lead TO-263 Surface mount package.

Other features include a guaranteed $\pm 4\%$ tolerance on output voltage under all conditions of input voltage and output load conditions, and $\pm 15\%$ on the oscillator frequency. External shutdown is included, featuring typically 90 μA standby current. Self protection features include a two stage

current limit for the output switch and an over temperature shutdown for complete protection under fault conditions.

Features

- 3.3V, 5V, and adjustable output versions
- Adjustable version output voltage range, 1.2V to 57V $\pm 4\%$ max over line and load conditions
- Guaranteed 2A output load current
- Available in 5-pin TO-220 and TO-263 (surface mount) Package
- Input voltage range up to 60V
- 150 kHz fixed frequency internal oscillator
- On/Off control
- Low power standby mode, I_Q typically 90 μA
- High Efficiency
- Thermal shutdown and current limit protection

Applications

- Simple high-efficiency step-down (buck) regulator
- Efficient pre-regulator for linear regulators
- On-card switching regulators
- Positive to Negative converter

Note: † Patent Number 5,382,918.

Typical Application (Fixed Output Voltage Versions)

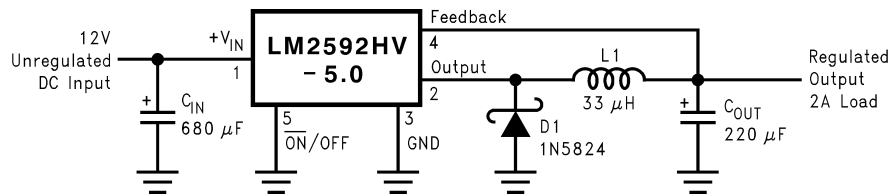

Connection Diagrams

Bent and Staggered Leads, Through Hole Package
5-Lead TO-220 (T)

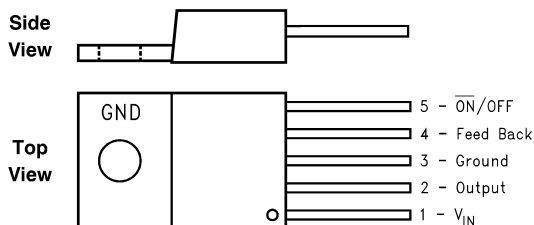

Order Number LM2592HVT-3.3, LM2592HVT-5.0,
or LM2592HVT-ADJ

Surface Mount Package
5-Lead TO-263 (S)

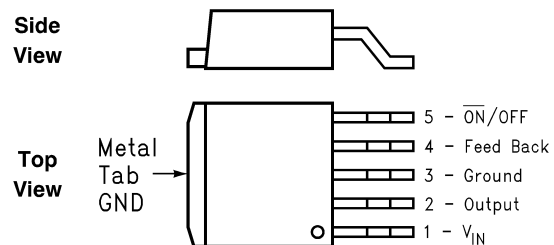

Order Number LM2592HVS-3.3, LM2592HVS-5.0,
or LM2592HVS-ADJ

Absolute Maximum Ratings (Note 1)

If Military/Aerospace specified devices are required, please contact the National Semiconductor Sales Office/ Distributors for availability and specifications.

Maximum Supply Voltage (V_{IN})	63V
ON/OFF Pin Voltage	$-0.3 \leq V \leq +25V$
Feedback Pin Voltage	$-0.3 \leq V \leq +25V$
Output Voltage to Ground (Steady State)	-1V
Power Dissipation	Internally limited
Storage Temperature Range	$-65^{\circ}C$ to $+150^{\circ}C$
ESD Susceptibility	

Human Body Model (Note 2)	2 kV
Lead Temperature	
S Package	
Vapor Phase (60 sec.)	$+215^{\circ}C$
Infrared (10 sec.)	$+245^{\circ}C$
T Package (Soldering, 10 sec.)	$+260^{\circ}C$
Maximum Junction Temperature	$+150^{\circ}C$

Operating Conditions

Temperature Range	$-40^{\circ}C \leq T_J \leq +125^{\circ}C$
Supply Voltage	4.5V to 60V

LM2592HV-3.3

Electrical Characteristics

Specifications with standard type face are for $T_J = 25^{\circ}C$, and those with **boldface type** apply over full Operating Temperature Range.

Symbol	Parameter	Conditions	LM2592HV-3.3		Units (Limits)
			Typ (Note 3)	Limit (Note 4)	
SYSTEM PARAMETERS (Note 5) Test Circuit <i>Figure 1</i>					
V_{OUT}	Output Voltage	$4.75V \leq V_{IN} \leq 60V, 0.2A \leq I_{LOAD} \leq 2A$	3.3	3.168/ 3.135 3.432/ 3.465	V V(min) V(max)
η	Efficiency	$V_{IN} = 12V, I_{LOAD} = 2A$	76		

LM2592HV-5.0

Electrical Characteristics

Specifications with standard type face are for $T_J = 25^{\circ}C$, and those with **boldface type** apply over full Operating Temperature Range.

Symbol	Parameter	Conditions	LM2592HV-5.0		Units (Limits)
			Typ (Note 3)	Limit (Note 4)	
SYSTEM PARAMETERS (Note 5) Test Circuit <i>Figure 1</i>					
V_{OUT}	Output Voltage	$7V \leq V_{IN} \leq 60V, 0.2A \leq I_{LOAD} \leq 2A$	5	4.800/ 4.750 5.200/ 5.250	V V(min) V(max)
η	Efficiency	$V_{IN} = 12V, I_{LOAD} = 2A$	81		%

LM2592HV-ADJ

Electrical Characteristics

Specifications with standard type face are for $T_J = 25^{\circ}C$, and those with **boldface type** apply over full Operating Temperature Range.

Symbol	Parameter	Conditions	LM2592HV-ADJ		Units (Limits)
			Typ (Note 3)	Limit (Note 4)	
SYSTEM PARAMETERS (Note 5) Test Circuit <i>Figure 1</i>					
V_{FB}	Feedback Voltage	$4.5V \leq V_{IN} \leq 60V, 0.2A \leq I_{LOAD} \leq 2A$ V_{OUT} programmed for 3V. Circuit of <i>Figure 1</i> .	1.230	1.193/ 1.180 1.267/ 1.280	V V(min) V(max)
η	Efficiency	$V_{IN} = 12V, V_{OUT} = 3V, I_{LOAD} = 2A$	75		%

All Output Voltage Versions Electrical Characteristics (Continued)

Note 1: Absolute Maximum Ratings indicate limits beyond which damage to the device may occur. Operating Ratings indicate conditions for which the device is intended to be functional, but do not guarantee specific performance limits. For guaranteed specifications and test conditions, see the Electrical Characteristics.

Note 2: The human body model is a 100 pF capacitor discharged through a 1.5k resistor into each pin.

Note 3: Typical numbers are at 25°C and represent the most likely norm.

Note 4: All limits guaranteed at room temperature (standard type face) and at **temperature extremes (bold type face)**. All room temperature limits are 100% production tested. All limits at **temperature extremes** are guaranteed via correlation using standard Statistical Quality Control (SQC) methods. All limits are used to calculate Average Outgoing Quality Level (AOQL).

Note 5: External components such as the catch diode, inductor, input and output capacitors can affect switching regulator system performance. When the LM2592HV is used as shown in the *Figure 1* test circuit, system performance will be as shown in system parameters section of Electrical Characteristics.

Note 6: The switching frequency is reduced when the second stage current limit is activated. The amount of reduction is determined by the severity of current overload.

Note 7: No diode, inductor or capacitor connected to output pin.

Note 8: Feedback pin removed from output and connected to 0V to force the output transistor switch ON.

Note 9: Feedback pin removed from output and connected to 12V for the 3.3V, 5V, and the ADJ. version to force the output transistor switch OFF.

Note 10: $V_{IN} = 60V$.

Note 11: Junction to ambient thermal resistance (no external heat sink) for the package mounted TO-220 package mounted vertically, with the leads soldered to a printed circuit board with (1 oz.) copper area of approximately 1 in².

Note 12: Junction to ambient thermal resistance with the TO-263 package tab soldered to a single sided printed circuit board with 0.5 in² of (1 oz.) copper area.

Note 13: Junction to ambient thermal resistance with the TO-263 package tab soldered to a single sided printed circuit board with 2.5 in² of (1 oz.) copper area.

Note 14: Junction to ambient thermal resistance with the TO-263 package tab soldered to a double sided printed circuit board with 3 in² of (1 oz.) copper area on the LM2592HVS side of the board, and approximately 16 in² of copper on the other side of the p-c board. See application hints in this data sheet and the thermal model in **Switchers Made Simple** available at <http://power.national.com>.

Typical Performance Characteristics (Circuit of Figure 1)

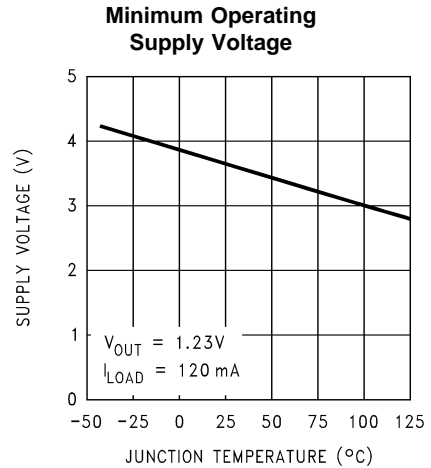
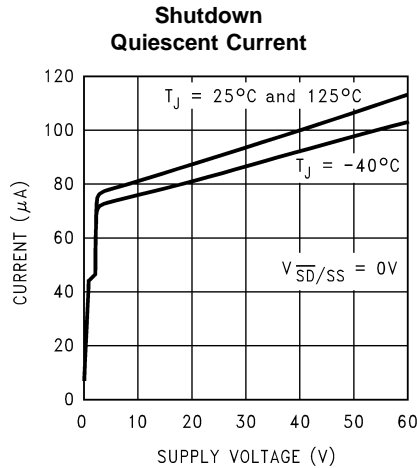
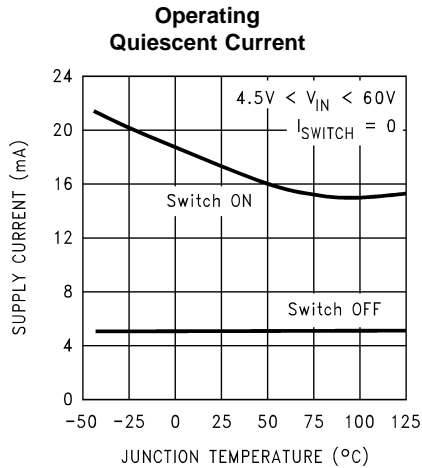
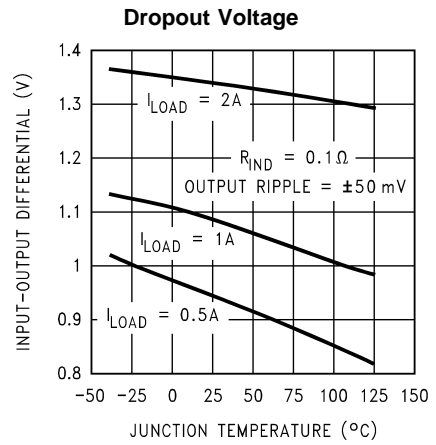
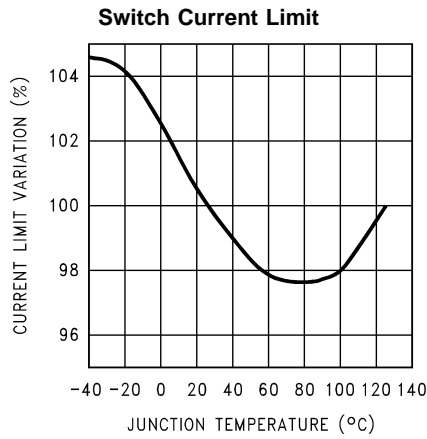
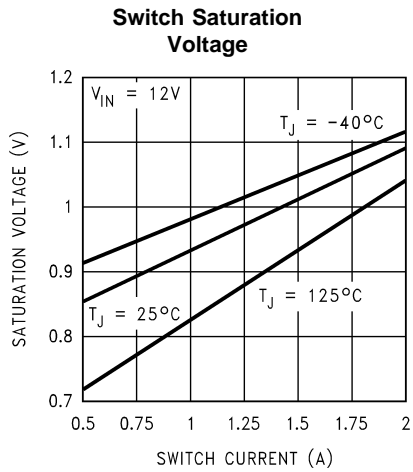
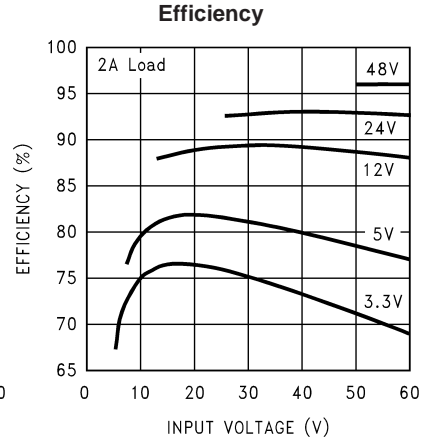
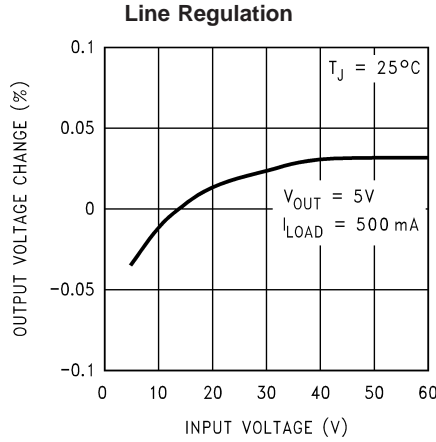
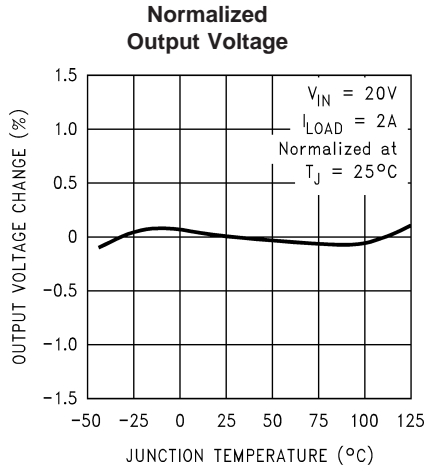

Typical Performance Characteristics (Circuit of Figure 1) (Continued)

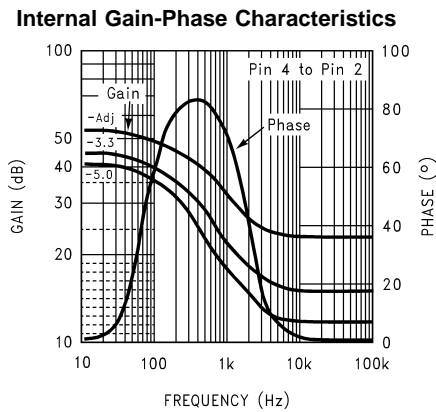
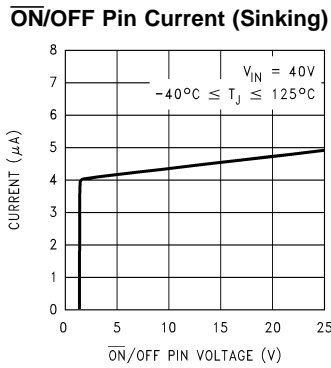
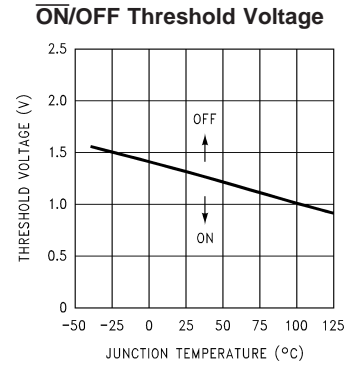
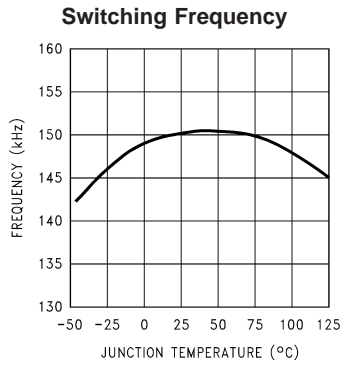
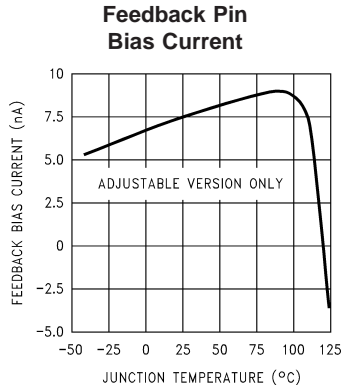

Block Diagram

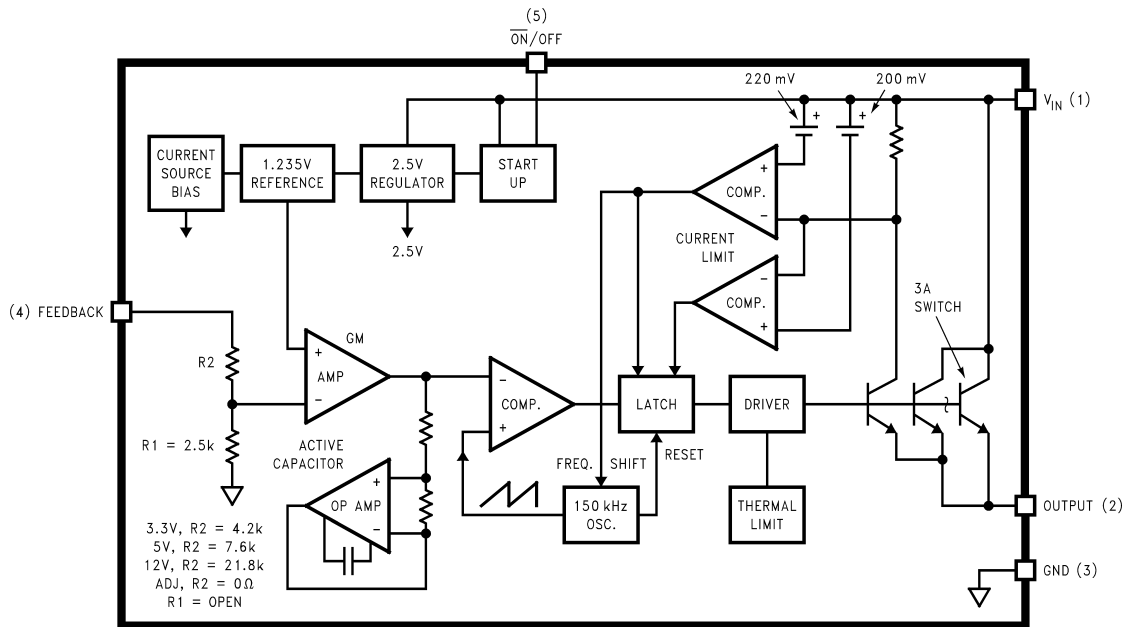

PIN FUNCTIONS

+V_{IN} (Pin 1)—This is the positive input supply for the IC switching regulator. A suitable input bypass capacitor must be present at this pin to minimize voltage transients and to supply the switching currents needed by the regulator.

Output (Pin 2)—Internal switch. The voltage at this pin switches between approximately $(+V_{IN} - V_{SAT})$ and approximately $-0.5V$, with a duty cycle of V_{OUT}/V_{IN} .

Ground (Pin 3)—Circuit ground.

Feedback (Pin 4)—Senses the regulated output voltage to complete the feedback loop. This pin is directly connected to the Output for the fixed voltage versions, but is set to 1.23V by means of a resistive divider from the output for the Adjustable version. If a feedforward capacitor is used (Adjustable version), then a negative voltage spike is generated

on this pin whenever the output is shorted. This happens because the feedforward capacitor cannot discharge fast enough, and since one end of it is dragged to Ground, the other end goes momentarily negative. To prevent the energy rating of this pin from being exceeded, a small-signal Schottky diode to Ground is recommended for DC input voltages above 40V whenever a feedforward capacitor is present (See Figure 1). Feedforward capacitor values larger than 0.1 μF are not recommended for the same reason, whatever be the DC input voltage.

ON /OFF (Pin 5)—The regulator is in shutdown mode, drawing about 90 μA , when this pin is driven to a high level ($\geq 2.0V$), and is in normal operation when this Pin is left floating or driven to a low level ($\leq 0.6V$). The typical value of the threshold is 1.3V and the voltage on this pin must not exceed 25V.

Important statement:

Huaguan Semiconductor Co,Ltd. reserves the right to change the products and services provided without notice. Customers should obtain the latest relevant information before ordering, and verify the timeliness and accuracy of this information.

Customers are responsible for complying with safety standards and taking safety measures when using our products for system design and machine manufacturing to avoid potential risks that may result in personal injury or property damage.

Our products are not licensed for applications in life support, military, aerospace, etc., so we do not bear the consequences of the application of these products in these fields.

Our documentation is only permitted to be copied without any tampering with the content, so we do not accept any responsibility or liability for the altered documents.

X-ON Electronics

Largest Supplier of Electrical and Electronic Components

Click to view similar products for [Isolated DC/DC Converters](#) category:

Click to view products by [HGSEMI](#) manufacturer:

Other Similar products are found below :

[ESM6D044440C05AAQ](#) [FMD15.24G](#) [PSL486-7LR](#) [PSR152.5-7IR](#) [Q48T30020-NBB0](#) [AVO240-48S12B-6L](#) [AVO250-48S28B-6L](#) [NAN-0505](#) [HW-L16D](#) [JAHW100Y1](#) [217-1617-001](#) [22827](#) [SPB05C-12](#) [SQ24S15033-PS0S](#) [18952](#) [19-130041](#) [CE-1003](#) [CE-1004](#) [GQ2541-7R](#) [PSE1000DCDC-12V](#) [RDS180245](#) [MAU228](#) [419-2065-201](#) [449-2075-101](#) [TME 0303S](#) [TME 0505S](#) [TME 1205S](#) [TME 1212S](#) [TME 2405S](#) [TME 2412S](#) [J80-0041NL](#) [V300C24C150BG](#) [419-2062-200](#) [419-2063-401](#) [419-2067-101](#) [419-2067-501](#) [419-2068-001](#) [DCG40-5G](#) [DFC15U48D15](#) [449-2067-000](#) [XGS-0512](#) [XGS-1205](#) [XGS-1212](#) [XGS-2412](#) [XGS-2415](#) [XKS-1215](#) [033456](#) [NCT1000N040R050B](#) [SPB05B-15](#) [SPB05C-15](#)