

SIMPLE SWITCHER[®] Power Converter 150 kHz 0.5A Step-Down Voltage Regulator

General Description

The LM2594/LM2594HV series of regulators are monolithic integrated circuits that provide all the active functions for a step-down (buck) switching regulator, capable of driving a 0.5A load with excellent line and load regulation. These devices are available in fixed output voltages of 3.3V, 5V, 12V, and an adjustable output version, and are packaged in a 8-lead DIP and a 8-lead surface mount package.

Requiring a minimum number of external components, these regulators are simple to use and feature internal frequency compensation†, a fixed-frequency oscillator, and improved line and load regulation specifications.

The LM2594/LM2594HV series operates at a switching frequency of 150 kHz thus allowing smaller sized filter components than what would be needed with lower frequency switching regulators. Because of its high efficiency, the copper traces on the printed circuit board are normally the only heat sinking needed.

A standard series of inductors (both through hole and surface mount types) are available from several different manufacturers optimized for use with the LM2594/LM2594HV series. This feature greatly simplifies the design of switch-mode power supplies.

Other features include a guaranteed $\pm 4\%$ tolerance on output voltage under all conditions of input voltage and output load conditions, and $\pm 15\%$ on the oscillator frequency. External shutdown is included, featuring typically 85 μ A standby current. Self protection features include a two stage frequency reducing current limit for the output switch and an over temperature shutdown for complete protection under fault conditions.

The LM2594HV is for applications requiring an input voltage up to 60V.

Features

- 3.3V, 5V, 12V, and adjustable output versions
- Adjustable version output voltage range, 1.2V to 37V (57V for the HV version) $\pm 4\%$ max over line and load conditions
- Available in 8-pin surface mount and DIP-8 package
- Guaranteed 0.5A output current
- Input voltage range up to 60V
- Requires only 4 external components
- 150 kHz fixed frequency internal oscillator
- TTL Shutdown capability
- Low power standby mode, I_Q typically 85 μ A
- High Efficiency
- Uses readily available standard inductors
- Thermal shutdown and current limit protection

Applications

- Simple high-efficiency step-down (buck) regulator
- Efficient pre-regulator for linear regulators
- On-card switching regulators
- Positive to Negative convertor

Typical Application (Fixed Output Voltage Versions)

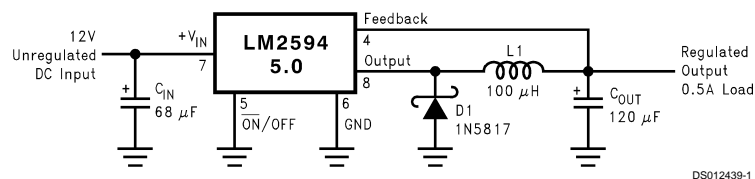

Connection Diagrams and Order Information

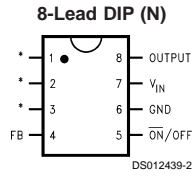

Top View
Order Number
LM2594N-3.3, LM2594N-5.0,
LM2594N-12 or LM2594N-ADJ
LM2594HVN-3.3, LM2594HVN-5.0,
LM2594HVN-12 or LM2594HVN-ADJ
See NS Package Number N08E

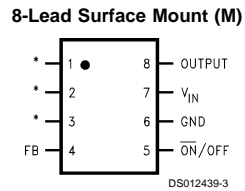

Top View
Order Number LM2594M-3.3,
LM2594M-5.0, LM2594M-12 or
LM2594M-ADJ
LM2594HVM-3.3, LM2594HVM-5.0,
LM2594HVM-12 or LM2594HVM-ADJ
See NS Package Number M08A

*No internal connection, but should be soldered to pc board for best heat transfer.

‡Patent Number 5,382,918.

Absolute Maximum Ratings (Note 1)

If Military/Aerospace specified devices are required, please contact the National Semiconductor Sales Office/Distributors for availability and specifications.

Maximum Supply Voltage	
LM2594	45V
LM2594HV	60V
ON/OFF Pin Input Voltage	$-0.3 \leq V \leq +25V$
Feedback Pin Voltage	$-0.3 \leq V \leq +25V$
Output Voltage to Ground (Steady State)	-1V
Power Dissipation	Internally limited
Storage Temperature Range	$-65^{\circ}C$ to $+150^{\circ}C$
ESD Susceptibility	

Human Body Model (Note 2)	2 kV
Lead Temperature	
M8 Package	
Vapor Phase (60 sec.)	+215 $^{\circ}C$
Infrared (15 sec.)	+220 $^{\circ}C$
N Package (Soldering, 10 sec.)	+260 $^{\circ}C$
Maximum Junction Temperature	+150 $^{\circ}C$

Operating Conditions

Temperature Range	$-40^{\circ}C \leq T_J \leq +125^{\circ}C$
Supply Voltage	
LM2594	4.5V to 40V
LM2594HV	4.5V to 60V

LM2594/LM2594HV-3.3 Electrical Characteristics

Specifications with standard type face are for $T_J = 25^{\circ}C$, and those with **boldface type** apply over full Operating Temperature Range. $V_{INmax} = 40V$ for the LM2594 and 60V for the LM2594HV.

Symbol	Parameter	Conditions	LM2594/LM2594HV-3.3		Units (Limits)
			Typ (Note 3)	Limit (Note 4)	
SYSTEM PARAMETERS (Note 5) Test Circuit <i>Figure 1</i>					
V_{OUT}	Output Voltage	$4.75V \leq V_{IN} \leq V_{INmax}$, $0.1A \leq I_{LOAD} \leq 0.5A$	3.3	3.168/ 3.135 3.432/ 3.465	V V(min) V(max)
η	Efficiency	$V_{IN} = 12V$, $I_{LOAD} = 0.5A$	80		%

LM2594/LM2594HV-5.0 Electrical Characteristics

Specifications with standard type face are for $T_J = 25^{\circ}C$, and those with **boldface type** apply over full Operating Temperature Range

Symbol	Parameter	Conditions	LM2594/LM2594HV-5.0		Units (Limits)
			Typ (Note 3)	Limit (Note 4)	
SYSTEM PARAMETERS (Note 5) Test Circuit <i>Figure 1</i>					
V_{OUT}	Output Voltage	$7V \leq V_{IN} \leq V_{INmax}$, $0.1A \leq I_{LOAD} \leq 0.5A$	5.0	4.800/ 4.750 5.200/ 5.250	V V(min) V(max)
η	Efficiency	$V_{IN} = 12V$, $I_{LOAD} = 0.5A$	82		%

LM2594/LM2594HV-12 Electrical Characteristics

Specifications with standard type face are for $T_J = 25^{\circ}C$, and those with **boldface type** apply over full Operating Temperature Range

Symbol	Parameter	Conditions	LM2594/LM2594HV-12		Units (Limits)
			Typ (Note 3)	Limit (Note 4)	
SYSTEM PARAMETERS (Note 5) Test Circuit <i>Figure 1</i>					
V_{OUT}	Output Voltage	$15V \leq V_{IN} \leq V_{INmax}$, $0.1A \leq I_{LOAD} \leq 0.5A$	12.0	11.52/ 11.40 12.48/ 12.60	V V(min) V(max)
η	Efficiency	$V_{IN} = 25V$, $I_{LOAD} = 0.5A$	88		%

LM2594/LM2594HV-ADJ Electrical Characteristics

Specifications with standard type face are for $T_J = 25^\circ\text{C}$, and those with **boldface type** apply over **full Operating Temperature Range**

Symbol	Parameter	Conditions	LM2594/LM2594HV-ADJ		Units (Limits)
			Typ (Note 3)	Limit (Note 4)	
SYSTEM PARAMETERS (Note 5) Test Circuit <i>Figure 1</i>					
V_{FB}	Feedback Voltage	$4.5\text{V} \leq V_{IN} \leq V_{INmax}$, $0.1\text{A} \leq I_{LOAD} \leq 0.5\text{A}$ V_{OUT} programmed for 3V. Circuit of <i>Figure 1</i>	1.230	1.193/ 1.180 1.267/ 1.280	V V(min) V(max)
η	Efficiency	$V_{IN} = 12\text{V}$, $I_{LOAD} = 0.5\text{A}$	80		%
<h3>All Output Voltage Versions Electrical Characteristics</h3> <p>Specifications with standard type face are for $T_J = 25^\circ\text{C}$, and those with boldface type apply over full Operating Temperature Range. Unless otherwise specified, $V_{IN} = 12\text{V}$ for the 3.3V, 5V, and Adjustable version and $V_{IN} = 24\text{V}$ for the 12V version. $I_{LOAD} = 100\text{mA}$</p>					
Symbol	Parameter	Conditions	LM2594/LM2594HV-XX		Units (Limits)
			Typ (Note 3)	Limit (Note 4)	
DEVICE PARAMETERS					
I_b	Feedback Bias Current	Adjustable Version Only, $V_{FB} = 1.3\text{V}$	10	50/ 100	nA
f_O	Oscillator Frequency	(Note 6)	150	127/ 110 173/ 173	kHz kHz(min) kHz(max)
V_{SAT}	Saturation Voltage	$I_{OUT} = 0.5\text{A}$ (Note 7) (Note 8)	0.9	1.1/ 1.2	V V(max)
DC	Max Duty Cycle (ON)	(Note 8)	100		%
	Min Duty Cycle (OFF)	(Note 9)	0		
I_{CL}	Current Limit	Peak Current, (Note 7) (Note 8)	0.8	0.65/ 0.58 1.3/ 1.4	A A(min) A(max)
I_L	Output Leakage Current	(Note 7) (Note 9) (Note 10) Output = 0V Output = -1V	2	50	$\mu\text{A}(\text{max})$
				15	mA(max)
I_Q	Quiescent Current	(Note 9)	5	10	mA mA(max)
I_{STBY}	Standby Quiescent Current	ON/OFF pin = 5V (OFF) (Note 10) LM2594 LM2594HV	85	200/ 250	$\mu\text{A}(\text{max})$ $\mu\text{A}(\text{max})$
				250/ 300	$\mu\text{A}(\text{max})$
θ_{JA}	Thermal Resistance	N Package, Junction to Ambient (Note 11)	95		$^\circ\text{C/W}$
		M Package, Junction to Ambient (Note 11)	150		
ON/OFF CONTROL Test Circuit <i>Figure 1</i>					
V_{IH} V_{IL}	ON /OFF Pin Logic Input Threshold Voltage	Low (Regulator ON)	1.3	0.6	V(max)
		High (Regulator OFF)		2.0	V(min)
I_H I_L	ON /OFF Pin Input Current	$V_{LOGIC} = 2.5\text{V}$ (Regulator OFF)	5	15	μA $\mu\text{A}(\text{max})$
		$V_{LOGIC} = 0.5\text{V}$ (Regulator ON)		0.02	5
<p>Note 1: Absolute Maximum Ratings indicate limits beyond which damage to the device may occur. Operating Ratings indicate conditions for which the device is intended to be functional, but do not guarantee specific performance limits. For guaranteed specifications and test conditions, see the Electrical Characteristics.</p>					

All Output Voltage Versions Electrical Characteristics (Continued)

Note 2: The human body model is a 100 pF capacitor discharged through a 1.5k resistor into each pin.

Note 3: Typical numbers are at 25°C and represent the most likely norm.

Note 4: All limits guaranteed at room temperature (standard type face) and at temperature extremes (bold type face). All room temperature limits are 100% production tested. All limits at temperature extremes are guaranteed via correlation using standard Statistical Quality Control (SQC) methods. All limits are used to calculate Average Outgoing Quality Level (AOQL).

Note 5: External components such as the catch diode, inductor, input and output capacitors, and voltage programming resistors can affect switching regulator system performance. When the LM2594/LM2594HV is used as shown in the *Figure 1* test circuit, system performance will be as shown in system parameters section of Electrical Characteristics.

Note 6: The switching frequency is reduced when the second stage current limit is activated. The amount of reduction is determined by the severity of current overload.

Note 7: No diode, inductor or capacitor connected to output pin.

Note 8: Feedback pin removed from output and connected to 0V to force the output transistor switch ON.

Note 9: Feedback pin removed from output and connected to 12V for the 3.3V, 5V, and the ADJ. version, and 15V for the 12V version, to force the output transistor switch OFF.

Note 10: $V_{IN} = 40V$ for the LM2594 and $60V$ for the LM2594HV.

Note 11: Junction to ambient thermal resistance with approximately 1 square inch of printed circuit board copper surrounding the leads. Additional copper area will lower thermal resistance further. See application hints in this data sheet and the thermal model in Switchers Made Simple[®] software.

Typical Performance Characteristics

Normalized Output Voltage

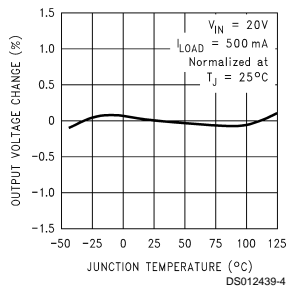

Line Regulation

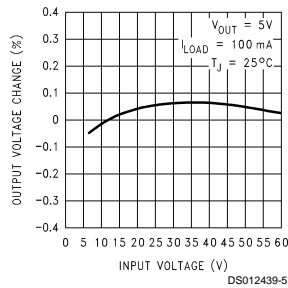

Efficiency

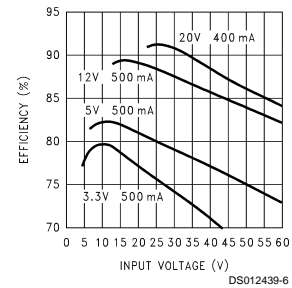

Switch Saturation Voltage

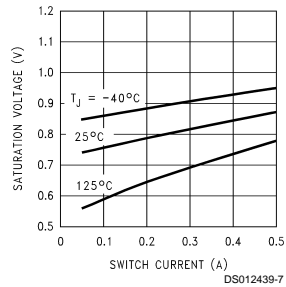

Switch Current Limit

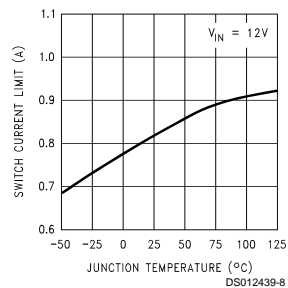

Dropout Voltage

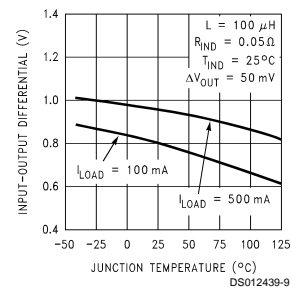

Typical Performance Characteristics (Continued)

Quiescent Current

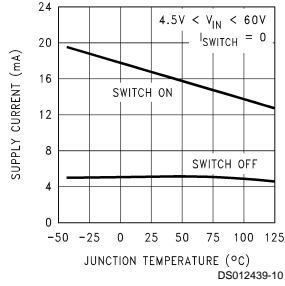

Standby Quiescent Current

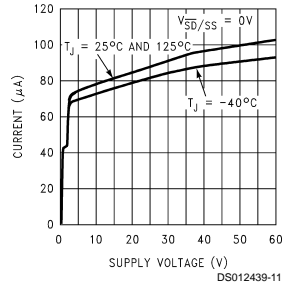

Minimum Operating Supply Voltage

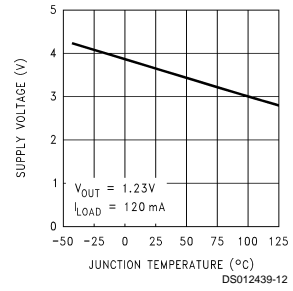

ON /OFF Threshold Voltage

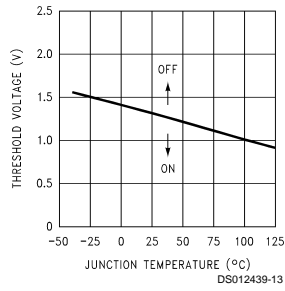

ON /OFF Pin Current (Sinking)

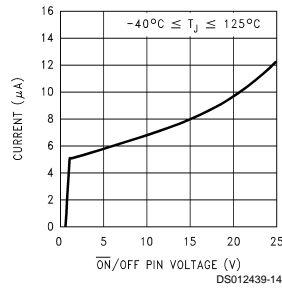

Switching Frequency

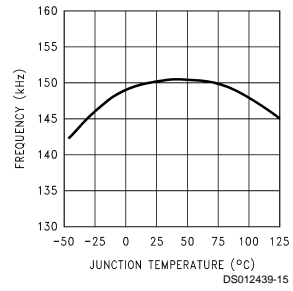

Feedback Pin Bias Current

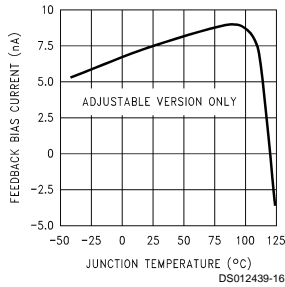

Typical Performance Characteristics

Continuous Mode Switching Waveforms

$V_{IN} = 20V$, $V_{OUT} = 5V$, $I_{LOAD} = 400\text{ mA}$
 $L = 100\ \mu\text{H}$, $C_{OUT} = 120\ \mu\text{F}$, $C_{OUT}\ \text{ESR} = 140\ \text{m}\Omega$

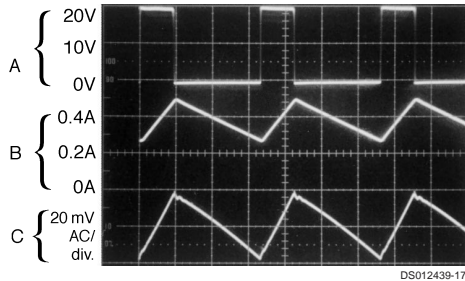

A: Output Pin Voltage, 10V/div.
 B: Inductor Current 0.2A/div.
 C: Output Ripple Voltage, 20 mV/div.

Horizontal Time Base: 2 $\mu\text{s}/\text{div}$.

Discontinuous Mode Switching Waveforms

$V_{IN} = 20V$, $V_{OUT} = 5V$, $I_{LOAD} = 200\text{ mA}$
 $L = 33\ \mu\text{H}$, $C_{OUT} = 220\ \mu\text{F}$, $C_{OUT}\ \text{ESR} = 60\ \text{m}\Omega$

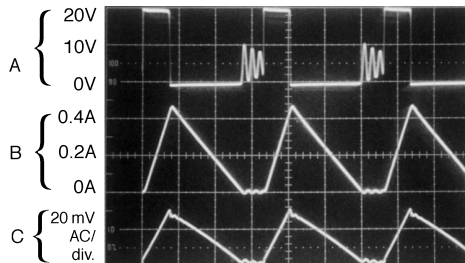

A: Output Pin Voltage, 10V/div.
 B: Inductor Current 0.2A/div.
 C: Output Ripple Voltage, 20 mV/div.

Horizontal Time Base: 2 $\mu\text{s}/\text{div}$.

Load Transient Response for Continuous Mode

$V_{IN} = 20V$, $V_{OUT} = 5V$, $I_{LOAD} = 200\text{ mA to } 500\text{ mA}$
 $L = 100\ \mu\text{H}$, $C_{OUT} = 120\ \mu\text{F}$, $C_{OUT}\ \text{ESR} = 140\ \text{m}\Omega$

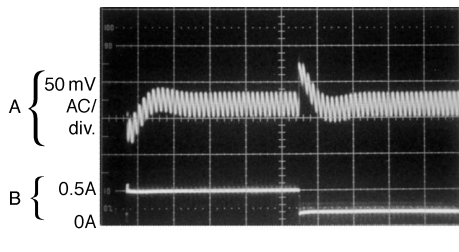

A: Output Voltage, 50 mV/div. (AC)
 B: 200 mA to 500 mA Load Pulse

Horizontal Time Base: 50 $\mu\text{s}/\text{div}$.

Load Transient Response for Discontinuous Mode

$V_{IN} = 20V$, $V_{OUT} = 5V$, $I_{LOAD} = 100\text{ mA to } 200\text{ mA}$
 $L = 33\ \mu\text{H}$, $C_{OUT} = 220\ \mu\text{F}$, $C_{OUT}\ \text{ESR} = 60\ \text{m}\Omega$

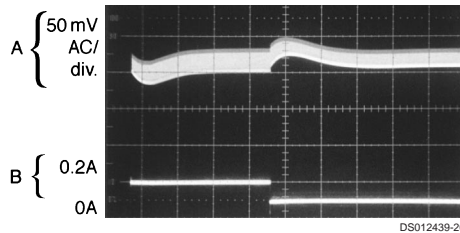

A: Output Voltage, 50 mV/div. (AC)
 B: 100 mA to 200 mA Load Pulse

Horizontal Time Base: 200 $\mu\text{s}/\text{div}$.

Typical Circuit and Layout Guidelines

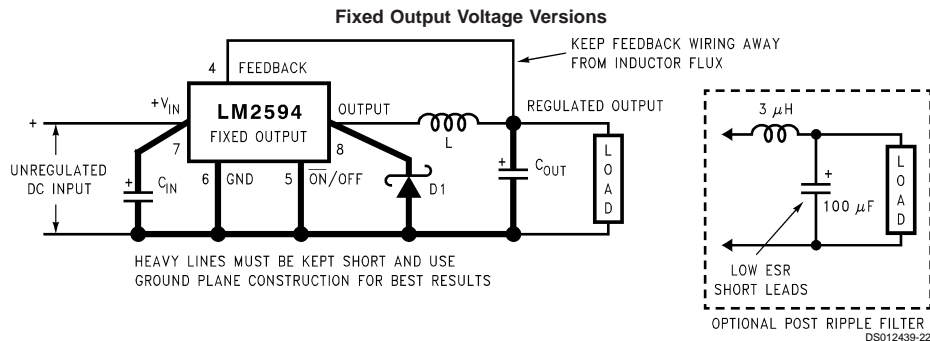

C_{IN} — 68 μF , 35V, Aluminum Electrolytic Nichicon "PL Series"
 C_{OUT} — 120 μF , 25V Aluminum Electrolytic, Nichicon "PL Series"
 $D1$ — 1A, 40V Schottky Rectifier, 1N5819
 $L1$ — 100 μH , L20

Select components with higher voltage ratings for designs using the LM2594HV with an input voltage between 40V and 60V.

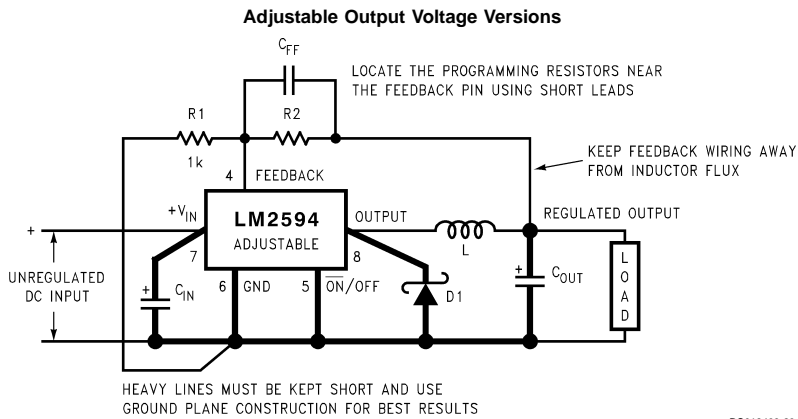

$$V_{OUT} = V_{REF} \left(1 + \frac{R_2}{R_1} \right) \quad \text{where } V_{REF} = 1.23\text{V}$$

$$R_2 = R_1 \left(\frac{V_{OUT}}{V_{REF}} - 1 \right) \quad \text{Select } R_1 \text{ to be approximately } 1 \text{ k}\Omega, \text{ use a } 1\% \text{ resistor for best stability.}$$

C_{IN} — 68 μF , 35V, Aluminum Electrolytic Nichicon "PL Series"
 C_{OUT} — 120 μF , 25V Aluminum Electrolytic, Nichicon "PL Series"
 $D1$ — 1A, 40V Schottky Rectifier, 1N5819
 $L1$ — 100 μH , L20
 R_1 — 1 k Ω , 1%
 C_{FF} — See Application Information Section

FIGURE 1. Typical Circuits and Layout Guides

As in any switching regulator, layout is very important. Rapidly switching currents associated with wiring inductance can generate voltage transients which can cause problems. For minimal inductance and ground loops, the wires indicated by **heavy lines should be wide printed circuit traces and should be kept as short as possible**. For best results, external components should be located as close to the switcher IC as possible using ground plane construction or single point grounding.

If **open core inductors are used**, special care must be taken as to the location and positioning of this type of inductor. Allowing the inductor flux to intersect sensitive feedback, IC groundpath and C_{OUT} wiring can cause problems.

When using the adjustable version, special care must be taken as to the location of the feedback resistors and the associated wiring. Physically locate both resistors near the IC, and route the wiring away from the inductor, especially an open core type of inductor. (See application section for more information.)

LM2594/LM2594HV Series Buck Regulator Design Procedure (Fixed Output)

PROCEDURE (Fixed Output Voltage Version)

Given:

V_{OUT} = Regulated Output Voltage (3.3V, 5V or 12V)

$V_{IN(max)}$ = Maximum DC Input Voltage

$I_{LOAD(max)}$ = Maximum Load Current

1. Inductor Selection (L1)

A. Select the correct inductor value selection guide from *Figures 4, 5* or *Figure 6*. (Output voltages of 3.3V, 5V, or 12V respectively.) For all other voltages, see the design procedure for the adjustable version.

B. From the inductor value selection guide, identify the inductance region intersected by the Maximum Input Voltage line and the Maximum Load Current line. Each region is identified by an inductance value and an inductor code (LXX).

C. Select an appropriate inductor from the four manufacturer's part numbers listed in *Figure 8*.

2. Output Capacitor Selection (C_{OUT})

A. In the majority of applications, low ESR (Equivalent Series Resistance) electrolytic capacitors between 82 μ F and 220 μ F and low ESR solid tantalum capacitors between 15 μ F and 100 μ F provide the best results. This capacitor should be located close to the IC using short capacitor leads and short copper traces. Do not use capacitors larger than 220 μ F.

For additional information, see section on output capacitors in application information section.

B. To simplify the capacitor selection procedure, refer to the quick design component selection table shown in *Figure 2*. This table contains different input voltages, output voltages, and load currents, and lists various inductors and output capacitors that will provide the best design solutions.

C. The capacitor voltage rating for electrolytic capacitors should be at least 1.5 times greater than the output voltage, and often much higher voltage ratings are needed to satisfy the low ESR requirements for low output ripple voltage.

D. For computer aided design software, see *Switchers Made Simple* version 4.1 or later.

EXAMPLE (Fixed Output Voltage Version)

Given:

V_{OUT} = 5V

$V_{IN(max)}$ = 12V

$I_{LOAD(max)}$ = 0.4A

1. Inductor Selection (L1)

A. Use the inductor selection guide for the 5V version shown in *Figure 5*.

B. From the inductor value selection guide shown in *Figure 5*, the inductance region intersected by the 12V horizontal line and the 0.4A vertical line is 100 μ H, and the inductor code is L20.

C. The inductance value required is 100 μ H. From the table in *Figure 8*, go to the L20 line and choose an inductor part number from any of the four manufacturers shown. (In most instances, both through hole and surface mount inductors are available.)

2. Output Capacitor Selection (C_{OUT})

A. See section on output capacitors in application information section.

B. From the quick design component selection table shown in *Figure 2*, locate the 5V output voltage section. In the load current column, choose the load current line that is closest to the current needed in your application, for this example, use the 0.5A line. In the maximum input voltage column, select the line that covers the input voltage needed in your application, in this example, use the 15V line. Continuing on this line are recommended inductors and capacitors that will provide the best overall performance.

The capacitor list contains both through hole electrolytic and surface mount tantalum capacitors from four different capacitor manufacturers. It is recommended that both the manufacturers and the manufacturer's series that are listed in the table be used.

In this example aluminum electrolytic capacitors from several different manufacturers are available with the range of ESR numbers needed.

120 μ F 25V Panasonic HFQ Series

120 μ F 25V Nichicon PL Series

C. For a 5V output, a capacitor voltage rating at least 7.5V or more is needed. But, in this example, even a low ESR, switching grade, 120 μ F 10V aluminum electrolytic capacitor would exhibit approximately 400 m Ω of ESR (see the curve in *Figure 14* for the ESR vs voltage rating). This amount of ESR would result in relatively high output ripple voltage. To reduce the ripple to 1% of the output voltage, or less, a capacitor with a higher voltage rating (lower ESR) should be selected. A 16V or 25V capacitor will reduce the ripple voltage by approximately half.

LM2594/LM2594HV Series Buck Regulator Design Procedure (Fixed Output) (Continued)

PROCEDURE (Fixed Output Voltage Version)

3. Catch Diode Selection (D1)

A. The catch diode current rating must be at least 1.3 times greater than the maximum load current. Also, if the power supply design must withstand a continuous output short, the diode should have a current rating equal to the maximum current limit of the LM2594. The most stressful condition for this diode is an overload or shorted output condition.

B. The reverse voltage rating of the diode should be at least 1.25 times the maximum input voltage.

C. This diode must be fast (short reverse recovery time) and must be located close to the LM2594 using short leads and short printed circuit traces. Because of their fast switching speed and low forward voltage drop, Schottky diodes provide the best performance and efficiency, and should be the first choice, especially in low output voltage applications. Ultra-fast recovery, or High-Efficiency rectifiers also provide good results. Ultra-fast recovery diodes typically have reverse recovery times of 50 ns or less. Rectifiers such as the 1N4001 series are much too slow and should not be used.

4. Input Capacitor (C_{IN})

A low ESR aluminum or tantalum bypass capacitor is needed between the input pin and ground to prevent large voltage transients from appearing at the input. In addition, the RMS current rating of the input capacitor should be selected to be at least ½ the DC load current. The capacitor manufacturers data sheet must be checked to assure that this current rating is not exceeded. The curve shown in *Figure 13* shows typical RMS current ratings for several different aluminum electrolytic capacitor values.

This capacitor should be located close to the IC using short leads and the voltage rating should be approximately 1.5 times the maximum input voltage.

If solid tantalum input capacitors are used, it is recommended that they be surge current tested by the manufacturer.

Use caution when using ceramic capacitors for input bypassing, because it may cause severe ringing at the V_{IN} pin.

For additional information, see section on input capacitors in Application Information section.

EXAMPLE (Fixed Output Voltage Version)

3. Catch Diode Selection (D1)

A. Refer to the table shown in *Figure 11*. In this example, a 1A, 20V, 1N5817 Schottky diode will provide the best performance, and will not be overstressed even for a shorted output.

4. Input Capacitor (C_{IN})

The important parameters for the Input capacitor are the input voltage rating and the RMS current rating. With a nominal input voltage of 12V, an aluminum electrolytic capacitor with a voltage rating greater than 18V (1.5 x V_{IN}) would be needed. The next higher capacitor voltage rating is 25V.

The RMS current rating requirement for the input capacitor in a buck regulator is approximately ½ the DC load current. In this example, with a 400 mA load, a capacitor with a RMS current rating of at least 200 mA is needed. The curves shown in *Figure 13* can be used to select an appropriate input capacitor. From the curves, locate the 25V line and note which capacitor values have RMS current ratings greater than 200 mA. Either a 47 µF or 68 µF, 25V capacitor could be used.

For a through hole design, a 68 µF/25V electrolytic capacitor (Panasonic HFQ series or Nichicon PL series or equivalent) would be adequate. Other types or other manufacturers capacitors can be used provided the RMS ripple current ratings are adequate.

For surface mount designs, solid tantalum capacitors are recommended. The TPS series available from AVX, and the 593D series from Sprague are both surge current tested.

LM2594/LM2594HV Series Buck Regulator Design Procedure (Fixed Output) (Continued)

Conditions			Inductor		Output Capacitor					
Output Voltage (V)	Load Current (A)	Max Input Voltage (V)	Inductance (μH)	Inductor (#)	Through Hole		Surface Mount			
					Panasonic HFQ Series (μF/V)	Nichicon PL Series (μF/V)	AVX TPS Series (μF/V)	Sprague 595D Series (μF/V)		
3.3	0.5	5	33	L14	220/16	220/16	100/16	100/6.3		
		7	47	L13	120/25	120/25	100/16	100/6.3		
		10	68	L21	120/25	120/25	100/16	100/6.3		
		40	100	L20	120/35	120/35	100/16	100/6.3		
	0.2	6	68	L4	120/25	120/25	100/16	100/6.3		
		10	150	L10	120/16	120/16	100/16	100/6.3		
5	0.5	8	47	L13	180/16	180/16	100/16	33/25		
		10	68	L21	180/16	180/16	100/16	33/25		
		15	100	L20	120/25	120/25	100/16	33/25		
		40	150	L19	120/25	120/25	100/16	33/25		
	0.2	9	150	L10	82/16	82/16	100/16	33/25		
		20	220	L9	120/16	120/16	100/16	33/25		
		40	330	L8	120/16	120/16	100/16	33/25		
		12	0.5	15	68	L21	82/25	82/25	100/16	15/25
				18	150	L19	82/25	82/25	100/16	15/25
30	220			L27	82/25	82/25	100/16	15/25		
40	330			L26	82/25	82/25	100/16	15/25		
0.2	15		100	L11	82/25	82/25	100/16	15/25		
	20		220	L9	82/25	82/25	100/16	15/25		
		40	330	L17	82/25	82/25	100/16	15/25		

FIGURE 2. LM2594/LM2594HV Fixed Voltage Quick Design Component Selection Table

LM2594/LM2594HV Series Buck Regulator Design Procedure (Adjustable Output)
PROCEDURE (Adjustable Output Voltage Version)
Given:

V_{OUT} = Regulated Output Voltage
 $V_{IN(max)}$ = Maximum Input Voltage
 $I_{LOAD(max)}$ = Maximum Load Current
 F = Switching Frequency (Fixed at a nominal 150 kHz).

EXAMPLE (Adjustable Output Voltage Version)
Given:

V_{OUT} = 20V
 $V_{IN(max)}$ = 28V
 $I_{LOAD(max)}$ = 0.5A
 F = Switching Frequency (Fixed at a nominal 150 kHz).

LM2594/LM2594HV Series Buck Regulator Design Procedure (Adjustable Output) (Continued)

PROCEDURE (Adjustable Output Voltage Version)

1. Programming Output Voltage (Selecting R_1 and R_2 , as shown in *Figure 1*).
Use the following formula to select the appropriate resistor values.

$$V_{OUT} = V_{REF} \left(1 + \frac{R_2}{R_1} \right) \text{ where } V_{REF} = 1.23V$$

Select a value for R_1 between 240Ω and $1.5\text{ k}\Omega$. The lower resistor values minimize noise pickup in the sensitive feedback pin. (For the lowest temperature coefficient and the best stability with time, use 1% metal film resistors.)

$$R_2 = R_1 \left(\frac{V_{OUT}}{V_{REF}} - 1 \right)$$

2. Inductor Selection (L1)

A. Calculate the inductor Volt microsecond constant $E \cdot T$ ($V \cdot \mu s$), from the following formula:

$$E \cdot T = (V_{IN} - V_{OUT} - V_{SAT}) \cdot \frac{V_{OUT} + V_D}{V_{IN} - V_{SAT} + V_D} \cdot \frac{1000}{150\text{ kHz}} (V \cdot \mu s)$$

where V_{SAT} = internal switch saturation voltage = $0.9V$
and V_D = diode forward voltage drop = $0.5V$

B. Use the $E \cdot T$ value from the previous formula and match it with the $E \cdot T$ number on the vertical axis of the Inductor Value Selection Guide shown in *Figure 7*.

C. on the horizontal axis, select the maximum load current.

D. Identify the inductance region intersected by the $E \cdot T$ value and the Maximum Load Current value. Each region is identified by an inductance value and an inductor code (LXX).

E. Select an appropriate inductor from the four manufacturer's part numbers listed in *Figure 8*.

3. Output Capacitor Selection (C_{OUT})

A. In the majority of applications, low ESR electrolytic or solid tantalum capacitors between $82\mu F$ and $220\mu F$ provide the best results. This capacitor should be located close to the IC using short capacitor leads and short copper traces. Do not use capacitors larger than $220\mu F$. **For additional information, see section on output capacitors in application information section.**

B. To simplify the capacitor selection procedure, refer to the quick design table shown in *Figure 3*. This table contains different output voltages, and lists various output capacitors that will provide the best design solutions.

C. The capacitor voltage rating should be at least 1.5 times greater than the output voltage, and often much higher voltage ratings are needed to satisfy the low ESR requirements needed for low output ripple voltage.

EXAMPLE (Adjustable Output Voltage Version)

1. Programming Output Voltage (Selecting R_1 and R_2 , as shown in *Figure 1*)

Select R_1 to be $1\text{ k}\Omega$, 1%. Solve for R_2 .

$$R_2 = R_1 \left(\frac{V_{OUT}}{V_{REF}} - 1 \right) = 1k \left(\frac{20V}{1.23V} - 1 \right)$$

$R_2 = 1k (16.26 - 1) = 15.26k$, closest 1% value is $15.4\text{ k}\Omega$.
 $R_2 = 15.4\text{ k}\Omega$.

2. Inductor Selection (L1)

A. Calculate the inductor Volt \cdot microsecond constant ($E \cdot T$),

$$E \cdot T = (28 - 20 - 0.9) \cdot \frac{20 + 0.5}{28 - 0.9 + 0.5} \cdot \frac{1000}{150} (V \cdot \mu s)$$

$$E \cdot T = (7.1) \cdot \frac{20.5}{27.6} \cdot 6.67 (V \cdot \mu s) = 35.2 (V \cdot \mu s)$$

B. $E \cdot T = 35.2 (V \cdot \mu s)$

C. $I_{LOAD(max)} = 0.5A$

D. From the inductor value selection guide shown in *Figure 7*, the inductance region intersected by the $35 (V \cdot \mu s)$ horizontal line and the $0.5A$ vertical line is $150\mu H$, and the inductor code is L19.

E. From the table in *Figure 8*, locate line L19, and select an inductor part number from the list of manufacturers part numbers.

3. Output Capacitor Selection (C_{OUT})

A. See section on C_{OUT} in Application Information section.

B. From the quick design table shown in *Figure 3*, locate the output voltage column. From that column, locate the output voltage closest to the output voltage in your application. In this example, select the $24V$ line. Under the output capacitor section, select a capacitor from the list of through hole electrolytic or surface mount tantalum types from four different capacitor manufacturers. It is recommended that both the manufacturers and the manufacturers series that are listed in the table be used.

In this example, through hole aluminum electrolytic capacitors from several different manufacturers are available.

$82\mu F$ $50V$ Panasonic HFQ Series

$120\mu F$ $50V$ Nichicon PL Series

C. For a $20V$ output, a capacitor rating of at least $30V$ or more is needed. In this example, either a $35V$ or $50V$ capacitor would work. A $50V$ rating was chosen because it has a lower ESR which provides a lower output ripple voltage.

Other manufacturers or other types of capacitors may also be used, provided the capacitor specifications (especially the 100 kHz ESR) closely match the types listed in the table. Refer to the capacitor manufacturers data sheet for this information.

LM2594/LM2594HV Series Buck Regulator Design Procedure (Adjustable Output) (Continued)

PROCEDURE (Adjustable Output Voltage Version)

4. Feedforward Capacitor (C_{FF}) (See *Figure 1*)

For output voltages greater than approximately 10V, an additional capacitor is required. The compensation capacitor is typically between 50 pF and 10 nF, and is wired in parallel with the output voltage setting resistor, R_2 . It provides additional stability for high output voltages, low input-output voltages, and/or very low ESR output capacitors, such as solid tantalum capacitors.

$$C_{FF} = \frac{1}{31 \times 10^3 \times R_2}$$

This capacitor type can be ceramic, plastic, silver mica, etc. (Because of the unstable characteristics of ceramic capacitors made with Z5U material, they are not recommended.)

5. Catch Diode Selection (D1)

A. The catch diode current rating must be at least 1.3 times greater than the maximum load current. Also, if the power supply design must withstand a continuous output short, the diode should have a current rating equal to the maximum current limit of the LM2594. The most stressful condition for this diode is an overload or shorted output condition.

B. The reverse voltage rating of the diode should be at least 1.25 times the maximum input voltage.

C. This diode must be fast (short reverse recovery time) and must be located close to the LM2594 using short leads and short printed circuit traces. Because of their fast switching speed and low forward voltage drop, Schottky diodes provide the best performance and efficiency, and should be the first choice, especially in low output voltage applications. Ultra-fast recovery, or High-Efficiency rectifiers are also a good choice, but some types with an abrupt turn-off characteristic may cause instability or EMI problems. Ultra-fast recovery diodes typically have reverse recovery times of 50 ns or less. Rectifiers such as the 1N4001 series are much too slow and should not be used.

EXAMPLE (Adjustable Output Voltage Version)

4. Feedforward Capacitor (C_{FF})

The table shown in *Figure 3* contains feed forward capacitor values for various output voltages. In this example, a 1 nF capacitor is needed.

5. Catch Diode Selection (D1)

A. Refer to the table shown in *Figure 11*. Schottky diodes provide the best performance, and in this example a 1A, 40V, 1N5819 Schottky diode would be a good choice. The 1A diode rating is more than adequate and will not be overstressed even for a shorted output.

LM2594/LM2594HV Series Buck Regulator Design Procedure (Adjustable Output) (Continued)

PROCEDURE (Adjustable Output Voltage Version)

6. Input Capacitor (C_{IN})

A low ESR aluminum or tantalum bypass capacitor is needed between the input pin and ground to prevent large voltage transients from appearing at the input. In addition, the RMS current rating of the input capacitor should be selected to be at least ½ the DC load current. The capacitor manufacturers data sheet must be checked to assure that this current rating is not exceeded. The curve shown in *Figure 13* shows typical RMS current ratings for several different aluminum electrolytic capacitor values.

This capacitor should be located close to the IC using short leads and the voltage rating should be approximately 1.5 times the maximum input voltage.

If solid tantalum input capacitors are used, it is recommended that they be surge current tested by the manufacturer.

Use caution when using ceramic capacitors for input bypassing, because it may cause severe ringing at the V_{IN} pin.

For additional information, see section on input capacitors in application information section.

EXAMPLE (Adjustable Output Voltage Version)

6. Input Capacitor (C_{IN})

The important parameters for the Input capacitor are the input voltage rating and the RMS current rating. With a nominal input voltage of 28V, an aluminum electrolytic aluminum electrolytic capacitor with a voltage rating greater than 42V (1.5 x V_{IN}) would be needed. Since the next higher capacitor voltage rating is 50V, a 50V capacitor should be used. The capacitor voltage rating of (1.5 x V_{IN}) is a conservative guideline, and can be modified somewhat if desired.

The RMS current rating requirement for the input capacitor of a buck regulator is approximately ½ the DC load current. In this example, with a 400 mA load, a capacitor with a RMS current rating of at least 200 mA is needed.

The curves shown in *Figure 13* can be used to select an appropriate input capacitor. From the curves, locate the 50V line and note which capacitor values have RMS current ratings greater than 200 mA. A 47 µF/50V low ESR electrolytic capacitor is needed.

For a through hole design, a 47 µF/50V electrolytic capacitor (Panasonic HFQ series or Nichicon PL series or equivalent) would be adequate. Other types or other manufacturers capacitors can be used provided the RMS ripple current ratings are adequate.

For surface mount designs, solid tantalum capacitors are recommended. The TPS series available from AVX, and the 593D series from Sprague are both surge current tested.

*To further simplify the buck regulator design procedure, National Semiconductor is making available computer design software to be used with the Simple Switcher line of switching regulators. **Switchers Made Simple** (version 4.1 or later) is available from National's web site, www.national.com.*

Output Voltage (V)	Through Hole Output Capacitor			Surface Mount Output Capacitor		
	Panasonic HFQ Series (µF/V)	Nichicon PL Series (µF/V)	Feedforward Capacitor	AVX TPS Series (µF/V)	Sprague 595D Series (µF/V)	Feedforward Capacitor
1.2	220/25	220/25	0	220/10	220/10	0
4	180/25	180/25	4.7 nF	100/10	120/10	4.7 nF
6	82/25	82/25	4.7 nF	100/10	120/10	4.7 nF
9	82/25	82/25	3.3 nF	100/16	100/16	3.3 nF
12	82/25	82/25	2.2 nF	100/16	100/16	2.2 nF
15	82/25	82/25	1.5 nF	68/20	100/20	1.5 nF
24	82/50	120/50	1 nF	10/35	15/35	220 pF
28	82/50	120/50	820 pF	10/35	15/35	220 pF

FIGURE 3. Output Capacitor and Feedforward Capacitor Selection Table

LM2594/LM2594HV Series Buck Regulator Design Procedure

INDUCTOR VALUE SELECTION GUIDES (For Continuous Mode Operation)

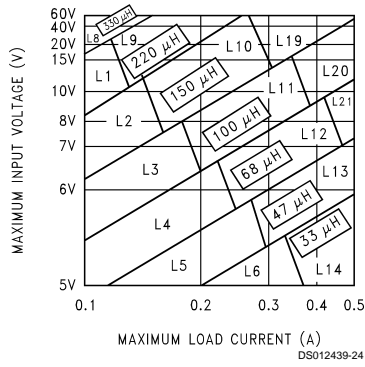

FIGURE 4. LM2594/LM2594HV-3.3

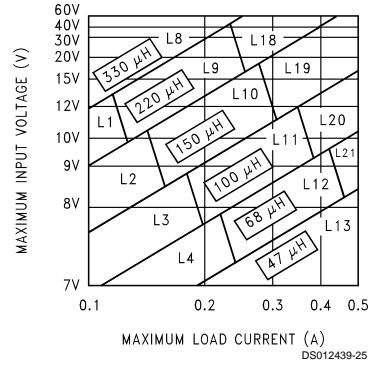

FIGURE 5. LM2594/LM2594HV-5.0

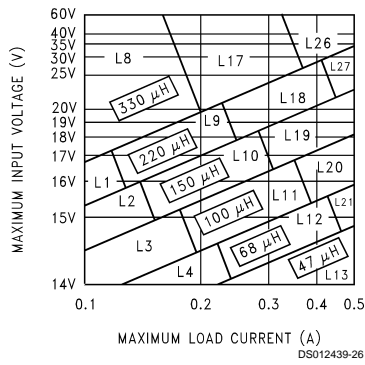

FIGURE 6. LM2594/LM2594HV-12

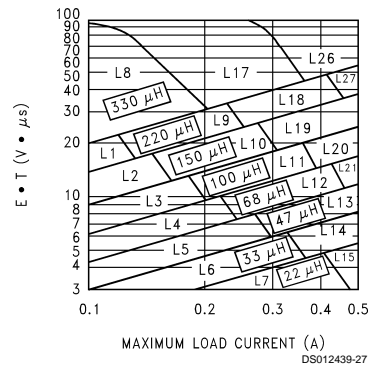

FIGURE 7. LM2594/LM2594HV-ADJ

LM2594/LM2594HV Series Buck Regulator Design Procedure (Continued)

	Induc- tance (μ H)	Cur- rent (A)	Schott		Renco		Pulse Engineering		Coilcraft
			Through Hole	Surface Mount	Through Hole	Surface Mount	Through Hole	Surface Mount	Surface Mount
L1	220	0.18	67143910	67144280	RL-5470-3	RL1500-220	PE-53801	PE-53801-S	DO1608-224
L2	150	0.21	67143920	67144290	RL-5470-4	RL1500-150	PE-53802	PE-53802-S	DO1608-154
L3	100	0.26	67143930	67144300	RL-5470-5	RL1500-100	PE-53803	PE-53803-S	DO1608-104
L4	68	0.32	67143940	67144310	RL-1284-68	RL1500-68	PE-53804	PE-53804-S	DO1608-68
L5	47	0.37	67148310	67148420	RL-1284-47	RL1500-47	PE-53805	PE-53805-S	DO1608-473
L6	33	0.44	67148320	67148430	RL-1284-33	RL1500-33	PE-53806	PE-53806-S	DO1608-333
L7	22	0.60	67148330	67148440	RL-1284-22	RL1500-22	PE-53807	PE-53807-S	DO1608-223
L8	330	0.26	67143950	67144320	RL-5470-2	RL1500-330	PE-53808	PE-53808-S	DO3308-334
L9	220	0.32	67143960	67144330	RL-5470-3	RL1500-220	PE-53809	PE-53809-S	DO3308-224
L10	150	0.39	67143970	67144340	RL-5470-4	RL1500-150	PE-53810	PE-53810-S	DO3308-154
L11	100	0.48	67143980	67144350	RL-5470-5	RL1500-100	PE-53811	PE-53811-S	DO3308-104
L12	68	0.58	67143990	67144360	RL-5470-6	RL1500-68	PE-53812	PE-53812-S	DO1608-683
L13	47	0.70	67144000	67144380	RL-5470-7	RL1500-47	PE-53813	PE-53813-S	DO3308-473
L14	33	0.83	67148340	67148450	RL-1284-33	RL1500-33	PE-53814	PE-53814-S	DO1608-333
L15	22	0.99	67148350	67148460	RL-1284-22	RL1500-22	PE-53815	PE-53815-S	DO1608-223
L16	15	1.24	67148360	67148470	RL-1284-15	RL1500-15	PE-53816	PE-53816-S	DO1608-153
L17	330	0.42	67144030	67144410	RL-5471-1	RL1500-330	PE-53817	PE-53817-S	DO3316-334
L18	220	0.55	67144040	67144420	RL-5471-2	RL1500-220	PE-53818	PE-53818-S	DO3316-224
L19	150	0.66	67144050	67144430	RL-5471-3	RL1500-150	PE-53819	PE-53819-S	DO3316-154
L20	100	0.82	67144060	67144440	RL-5471-4	RL1500-100	PE-53820	PE-53820-S	DO3316-104
L21	68	0.99	67144070	67144450	RL-5471-5	RL1500-68	PE-53821	PE-53821-S	DDO3316-683
L26	330	0.80	67144100	67144480	RL-5471-1	—	PE-53826	PE-53826-S	—
L27	220	1.00	67144110	67144490	RL-5471-2	—	PE-53827	PE-53827-S	—

FIGURE 8. Inductor Manufacturers Part Numbers

LM2594/LM2594HV Series Buck Regulator Design Procedure (Continued)

VR	1A Diodes			
	Surface Mount		Through Hole	
	Schottky	Ultra Fast Recovery	Schottky	Ultra Fast Recovery
20V		All of these diodes are rated to at least 60V.	1N5817	All of these diodes are rated to at least 60V.
30V	MBRS130		SR102	
			1N5818	
		SR103		
40V	MBRS140	MURS120	1N5819	MUR120
	10BQ040	10BF10	SR104	HER101
	10MQ040		11DQ03	11DF1
50V or more	MBRS160		SR105	
	10BQ050		MBR150	
	10MQ060		11DQ05	
	MBRS1100		MBR160	
	10MQ090		SB160	
	SGL41-60		11DQ10	
	SS16			

FIGURE 11. Diode Selection Table

Block Diagram

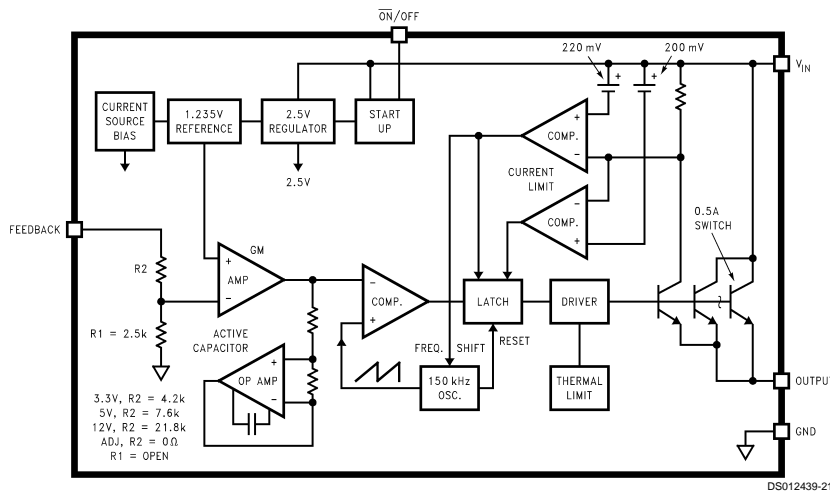

FIGURE 12.

Application Information

PIN FUNCTIONS

+V_{IN} — This is the positive input supply for the IC switching regulator. A suitable input bypass capacitor must be present at this pin to minimize voltage transients and to supply the switching currents needed by the regulator.

Ground — Circuit ground.

Output — Internal switch. The voltage at this pin switches between (+V_{IN} - V_{SAT}) and approximately -0.5V, with a duty cycle of V_{OUT}/V_{IN}. To minimize coupling to sensitive circuitry, the PC board copper area connected to this pin should be kept to a minimum.

Application Information (Continued)

Feedback — Senses the regulated output voltage to complete the feedback loop.

ON/OFF — Allows the switching regulator circuit to be shut down using logic level signals thus dropping the total input supply current to approximately 80 μ A. Pulling this pin below a threshold voltage of approximately 1.3V turns the regulator on, and pulling this pin above 1.3V (up to a maximum of 25V) shuts the regulator down. If this shutdown feature is not needed, the $\overline{\text{ON}}$ /OFF pin can be wired to the ground pin or it can be left open, in either case the regulator will be in the ON condition.

EXTERNAL COMPONENTS

C_{IN} — A low ESR aluminum or tantalum bypass capacitor is needed between the input pin and ground pin. It must be located near the regulator using short leads. This capacitor prevents large voltage transients from appearing at the input, and provides the instantaneous current needed each time the switch turns on.

The important parameters for the Input capacitor are the voltage rating and the RMS current rating. Because of the relatively high RMS currents flowing in a buck regulator's input capacitor, this capacitor should be chosen for its RMS current rating rather than its capacitance or voltage ratings, although the capacitance value and voltage rating are directly related to the RMS current rating.

The RMS current rating of a capacitor could be viewed as a capacitor's power rating. The RMS current flowing through the capacitor's internal ESR produces power which causes the internal temperature of the capacitor to rise. The RMS current rating of a capacitor is determined by the amount of current required to raise the internal temperature approximately 10°C above an ambient temperature of 105°C. The ability of the capacitor to dissipate this heat to the surrounding air will determine the amount of current the capacitor can safely sustain. Capacitors that are physically large and have a large surface area will typically have higher RMS current ratings. For a given capacitor value, a higher voltage electrolytic capacitor will be physically larger than a lower voltage capacitor, and thus be able to dissipate more heat to the surrounding air, and therefore will have a higher RMS current rating.

The consequences of operating an electrolytic capacitor above the RMS current rating is a shortened operating life. The higher temperature speeds up the evaporation of the capacitor's electrolyte, resulting in eventual failure.

Selecting an input capacitor requires consulting the manufacturers data sheet for maximum allowable RMS ripple current. For a maximum ambient temperature of 40°C, a general guideline would be to select a capacitor with a ripple current rating of approximately 50% of the DC load current. For ambient temperatures up to 70°C, a current rating of 75% of the DC load current would be a good choice for a conservative design. The capacitor voltage rating must be at least 1.25 times greater than the maximum input voltage, and often a much higher voltage capacitor is needed to satisfy the RMS current requirements.

A graph shown in *Figure 13* shows the relationship between an electrolytic capacitor value, its voltage rating, and the RMS current it is rated for. These curves were obtained from the Nichicon "PL" series of low ESR, high reliability electrolytic capacitors designed for switching regulator applications. Other capacitor manufacturers offer similar types of capacitors, but always check the capacitor data sheet.

"Standard" electrolytic capacitors typically have much higher ESR numbers, lower RMS current ratings and typically have a shorter operating lifetime.

Because of their small size and excellent performance, surface mount solid tantalum capacitors are often used for input bypassing, but several precautions must be observed. A small percentage of solid tantalum capacitors can short if the inrush current rating is exceeded. This can happen at turn on when the input voltage is suddenly applied, and of course, higher input voltages produce higher inrush currents. Several capacitor manufacturers do a 100% surge current testing on their products to minimize this potential problem. If high turn on currents are expected, it may be necessary to limit this current by adding either some resistance or inductance before the tantalum capacitor, or select a higher voltage capacitor. As with aluminum electrolytic capacitors, the RMS ripple current rating must be sized to the load current.

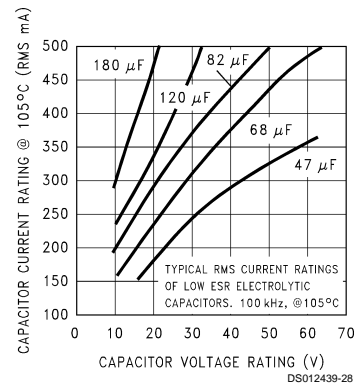

FIGURE 13. RMS Current Ratings for Low ESR Electrolytic Capacitors (Typical)

OUTPUT CAPACITOR

C_{OUT} — An output capacitor is required to filter the output and provide regulator loop stability. Low impedance or low ESR Electrolytic or solid tantalum capacitors designed for switching regulator applications must be used. When selecting an output capacitor, the important capacitor parameters are; the 100 kHz Equivalent Series Resistance (ESR), the RMS ripple current rating, voltage rating, and capacitance value. For the output capacitor, the ESR value is the most important parameter.

The output capacitor requires an ESR value that has an upper and lower limit. For low output ripple voltage, a low ESR value is needed. This value is determined by the maximum allowable output ripple voltage, typically 1% to 2% of the output voltage. But if the selected capacitor's ESR is extremely low, there is a possibility of an unstable feedback loop, resulting in an oscillation at the output. Using the capacitors listed in the tables, or similar types, will provide design solutions under all conditions.

If very low output ripple voltage (less than 15 mV) is required, refer to the section on Output Voltage Ripple and Transients for a post ripple filter.

An aluminum electrolytic capacitor's ESR value is related to the capacitance value and its voltage rating. In most cases, Higher voltage electrolytic capacitors have lower ESR values

Application Information (Continued)

(see Figure 14). Often, capacitors with much higher voltage ratings may be needed to provide the low ESR values required for low output ripple voltage.

The output capacitor for many different switcher designs often can be satisfied with only three or four different capacitor values and several different voltage ratings. See the quick design component selection tables in Figure 2 and Figure 3 for typical capacitor values, voltage ratings, and manufacturers capacitor types.

Electrolytic capacitors are not recommended for temperatures below -25°C. The ESR rises dramatically at cold temperatures and typically rises 3X @ -25°C and as much as 10X at -40°C. See curve shown in Figure 15.

Solid tantalum capacitors have a much better ESR spec for cold temperatures and are recommended for temperatures below -25°C.

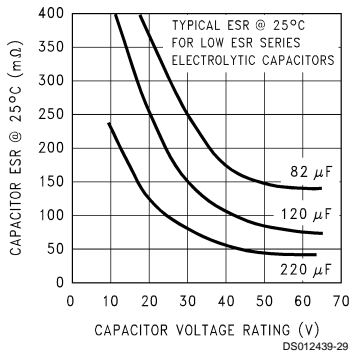

FIGURE 14. Capacitor ESR vs Capacitor Voltage Rating (Typical Low ESR Electrolytic Capacitor)

CATCH DIODE

Buck regulators require a diode to provide a return path for the inductor current when the switch turns off. This must be a fast diode and must be located close to the LM2594 using short leads and short printed circuit traces.

Because of their very fast switching speed and low forward voltage drop, Schottky diodes provide the best performance, especially in low output voltage applications (5V and lower). Ultra-fast recovery, or High-Efficiency rectifiers are also a good choice, but some types with an abrupt turnoff characteristic may cause instability or EMI problems. Ultra-fast recovery diodes typically have reverse recovery times of 50 ns or less. Rectifiers such as the 1N4001 series are much too slow and should not be used.

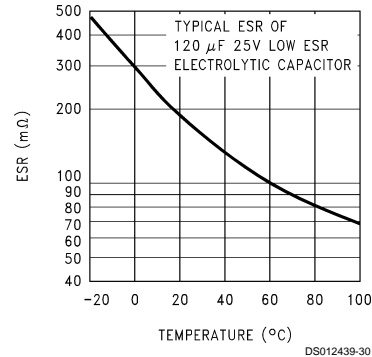

FIGURE 15. Capacitor ESR Change vs Temperature

INDUCTOR SELECTION

All switching regulators have two basic modes of operation; continuous and discontinuous. The difference between the two types relates to the inductor current, whether it is flowing continuously, or if it drops to zero for a period of time in the normal switching cycle. Each mode has distinctively different operating characteristics, which can affect the regulators performance and requirements. Most switcher designs will operate in the discontinuous mode when the load current is low.

The LM2594 (or any of the Simple Switcher family) can be used for both continuous or discontinuous modes of operation.

In many cases the preferred mode of operation is the continuous mode. It offers greater output power, lower peak switch, inductor and diode currents, and can have lower output ripple voltage. But it does require larger inductor values to keep the inductor current flowing continuously, especially at low output load currents and/or high input voltages.

To simplify the inductor selection process, an inductor selection guide (nomograph) was designed (see Figure 4 through Figure 7). This guide assumes that the regulator is operating in the continuous mode, and selects an inductor that will allow a peak-to-peak inductor ripple current to be a certain percentage of the maximum design load current. This peak-to-peak inductor ripple current percentage is not fixed, but is allowed to change as different design load currents are selected. (See Figure 16.)

Application Information (Continued)

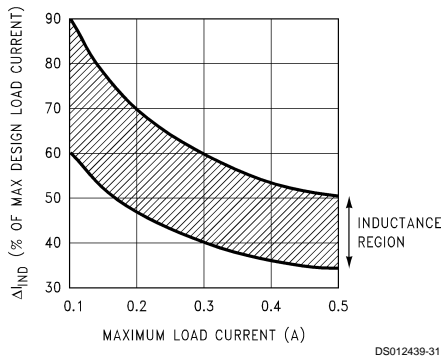

FIGURE 16. (ΔI_{IND}) Peak-to-Peak Inductor Ripple Current (as a Percentage of the Load Current) vs Load Current

By allowing the percentage of inductor ripple current to increase for low load currents, the inductor value and size can be kept relatively low.

When operating in the continuous mode, the inductor current waveform ranges from a triangular to a sawtooth type of waveform (depending on the input voltage), with the average value of this current waveform equal to the DC output load current.

Inductors are available in different styles such as pot core, toroid, E-core, bobbin core, etc., as well as different core materials, such as ferrites and powdered iron. The least expensive, the bobbin, rod or stick core, consists of wire wrapped on a ferrite bobbin. This type of construction makes for an inexpensive inductor, but since the magnetic flux is not completely contained within the core, it generates more Electro-Magnetic Interference (EMI). This magnetic flux can induce voltages into nearby printed circuit traces, thus causing problems with both the switching regulator operation and nearby sensitive circuitry, and can give incorrect scope readings because of induced voltages in the scope probe. Also see section on Open Core Inductors.

The inductors listed in the selection chart include ferrite E-core construction for Schott, ferrite bobbin core for Renco and Coilcraft, and powdered iron toroid for Pulse Engineering.

Exceeding an inductor's maximum current rating may cause the inductor to overheat because of the copper wire losses, or the core may saturate. If the inductor begins to saturate, the inductance decreases rapidly and the inductor begins to look mainly resistive (the DC resistance of the winding). This can cause the switch current to rise very rapidly and force the switch into a cycle-by-cycle current limit, thus reducing the DC output load current. This can also result in overheating of the inductor and/or the LM2594. Different inductor types have different saturation characteristics, and this should be kept in mind when selecting an inductor.

The inductor manufacturers data sheets include current and energy limits to avoid inductor saturation.

DISCONTINUOUS MODE OPERATION

The selection guide chooses inductor values suitable for continuous mode operation, but for low current applications and/or high input voltages, a discontinuous mode design

may be a better choice. It would use an inductor that would be physically smaller, and would need only one half to one third the inductance value needed for a continuous mode design. The peak switch and inductor currents will be higher in a discontinuous design, but at these low load currents (200 mA and below), the maximum switch current will still be less than the switch current limit.

Discontinuous operation can have voltage waveforms that are considerably different than a continuous design. The output pin (switch) waveform can have some damped sinusoidal ringing present. (See photo titled; Discontinuous Mode Switching Waveforms) This ringing is normal for discontinuous operation, and is not caused by feedback loop instabilities. In discontinuous operation, there is a period of time where neither the switch or the diode are conducting, and the inductor current has dropped to zero. During this time, a small amount of energy can circulate between the inductor and the switch/diode parasitic capacitance causing this characteristic ringing. Normally this ringing is not a problem, unless the amplitude becomes great enough to exceed the input voltage, and even then, there is very little energy present to cause damage.

Different inductor types and/or core materials produce different amounts of this characteristic ringing. Ferrite core inductors have very little core loss and therefore produce the most ringing. The higher core loss of powdered iron inductors produce less ringing. If desired, a series RC could be placed in parallel with the inductor to dampen the ringing. The computer aided design software *Switchers Made Simple* (version 4.1) will provide all component values for continuous and discontinuous modes of operation.

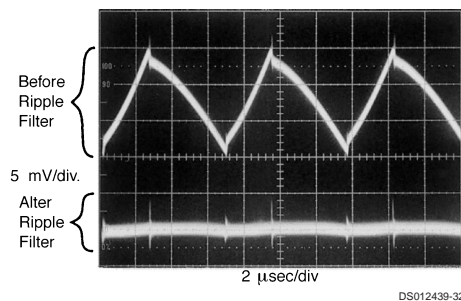

FIGURE 17. Post Ripple Filter Waveform

OUTPUT VOLTAGE RIPPLE AND TRANSIENTS

The output voltage of a switching power supply operating in the continuous mode will contain a sawtooth ripple voltage at the switcher frequency, and may also contain short voltage spikes at the peaks of the sawtooth waveform.

The output ripple voltage is a function of the inductor sawtooth ripple current and the ESR of the output capacitor. A typical output ripple voltage can range from approximately 0.5% to 3% of the output voltage. To obtain low ripple voltage, the ESR of the output capacitor must be low, however, caution must be exercised when using extremely low ESR capacitors because they can affect the loop stability, resulting in oscillation problems. If very low output ripple voltage is needed (less than 15 mV), a post ripple filter is recommended. (See Figure 1.) The inductance required is typically between 1 μH and 5 μH, with low DC resistance, to maintain good load regulation. A low ESR output filter capacitor is also required to assure good dynamic load response and ripple

Application Information (Continued)

reduction. The ESR of this capacitor may be as low as desired, because it is out of the regulator feedback loop. The photo shown in *Figure 17* shows a typical output ripple voltage, with and without a post ripple filter.

When observing output ripple with a scope, it is essential that a short, low inductance scope probe ground connection be used. Most scope probe manufacturers provide a special probe terminator which is soldered onto the regulator board, preferable at the output capacitor. This provides a very short scope ground thus eliminating the problems associated with the 3 inch ground lead normally provided with the probe, and provides a much cleaner and more accurate picture of the ripple voltage waveform.

The voltage spikes are caused by the fast switching action of the output switch and the diode, and the parasitic inductance of the output filter capacitor, and its associated wiring. To minimize these voltage spikes, the output capacitor should be designed for switching regulator applications, and the lead lengths must be kept very short. Wiring inductance, stray capacitance, as well as the scope probe used to evaluate these transients, all contribute to the amplitude of these spikes.

When a switching regulator is operating in the continuous mode, the inductor current waveform ranges from a triangular to a sawtooth type of waveform (depending on the input voltage). For a given input and output voltage, the peak-to-peak amplitude of this inductor current waveform remains constant. As the load current increases or decreases, the entire sawtooth current waveform also rises and falls. The average value (or the center) of this current waveform is equal to the DC load current.

If the load current drops to a low enough level, the bottom of the sawtooth current waveform will reach zero, and the switcher will smoothly change from a continuous to a discontinuous mode of operation. Most switcher designs (irregardless how large the inductor value is) will be forced to run discontinuous if the output is lightly loaded. This is a perfectly acceptable mode of operation.

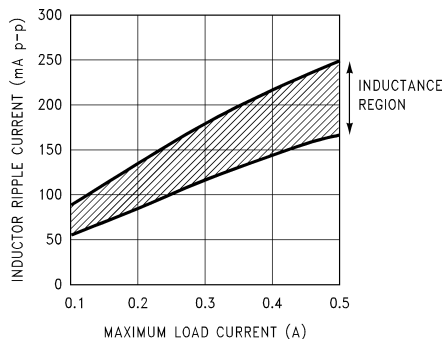

FIGURE 18. Peak-to-Peak Inductor Ripple Current vs Load Current

In a switching regulator design, knowing the value of the peak-to-peak inductor ripple current (ΔI_{IND}) can be useful for determining a number of other circuit parameters. Parameters such as, peak inductor or peak switch current, minimum load current before the circuit becomes discontinuous, output ripple voltage and output capacitor ESR can all be calculated from the peak-to-peak ΔI_{IND} . When the inductor

nomographs shown in *Figure 4* through *Figure 7* are used to select an inductor value, the peak-to-peak inductor ripple current can immediately be determined. The curve shown in *Figure 18* shows the range of (ΔI_{IND}) that can be expected for different load currents. The curve also shows how the peak-to-peak inductor ripple current (ΔI_{IND}) changes as you go from the lower border to the upper border (for a given load current) within an inductance region. The upper border represents a higher input voltage, while the lower border represents a lower input voltage (see Inductor Selection Guides).

These curves are only correct for continuous mode operation, and only if the inductor selection guides are used to select the inductor value

Consider the following example:

$$V_{OUT} = 5V, \text{ maximum load current of } 300 \text{ mA}$$

$$V_{IN} = 15V, \text{ nominal, varying between } 11V \text{ and } 20V.$$

The selection guide in *Figure 5* shows that the vertical line for a 0.3A load current, and the horizontal line for the 15V input voltage intersect approximately midway between the upper and lower borders of the 150 μH inductance region. A 150 μH inductor will allow a peak-to-peak inductor current (ΔI_{IND}) to flow that will be a percentage of the maximum load current. Referring to *Figure 18*, follow the 0.3A line approximately midway into the inductance region, and read the peak-to-peak inductor ripple current (ΔI_{IND}) on the left hand axis (approximately 150 mA p-p).

As the input voltage increases to 20V, it approaches the upper border of the inductance region, and the inductor ripple current increases. Referring to the curve in *Figure 18*, it can be seen that for a load current of 0.3A, the peak-to-peak inductor ripple current (ΔI_{IND}) is 150 mA with 15V in, and can range from 175 mA at the upper border (20V in) to 120 mA at the lower border (11V in).

Once the ΔI_{IND} value is known, the following formulas can be used to calculate additional information about the switching regulator circuit.

1. Peak Inductor or peak switch current

$$= \left(I_{LOAD} + \frac{\Delta I_{IND}}{2} \right) = \left(0.3A + \frac{0.150}{2} \right) = 0.375A$$

2. Minimum load current before the circuit becomes discontinuous

$$= \frac{\Delta I_{IND}}{2} = \frac{0.150}{2} = 0.075A$$

3. Output Ripple Voltage

$$= (\Delta I_{IND}) \times (\text{ESR of } C_{OUT})$$

$$= 0.150A \times 0.240\Omega = 36 \text{ mV p-p}$$

or

4. ESR of C_{OUT}

$$= \frac{\text{Output Ripple Voltage } (\Delta V_{OUT})}{\Delta I_{IND}}$$

$$= \frac{0.036V}{0.150A} = 0.240\Omega$$

OPEN CORE INDUCTORS

Another possible source of increased output ripple voltage or unstable operation is from an open core inductor. Ferrite bobbin or stick inductors have magnetic lines of flux flowing through the air from one end of the bobbin to the other end.

Application Information (Continued)

These magnetic lines of flux will induce a voltage into any wire or PC board copper trace that comes within the inductor's magnetic field. The strength of the magnetic field, the orientation and location of the PC copper trace to the magnetic field, and the distance between the copper trace and the inductor, determine the amount of voltage generated in the copper trace. Another way of looking at this inductive coupling is to consider the PC board copper trace as one turn of a transformer (secondary) with the inductor winding as the primary. Many millivolts can be generated in a copper trace located near an open core inductor which can cause stability problems or high output ripple voltage problems.

If unstable operation is seen, and an open core inductor is used, it's possible that the location of the inductor with respect to other PC traces may be the problem. To determine if this is the problem, temporarily raise the inductor away from the board by several inches and then check circuit operation. If the circuit now operates correctly, then the magnetic flux from the open core inductor is causing the problem. Substituting a closed core inductor such as a torroid or E-core will correct the problem, or re-arranging the PC layout may be necessary. Magnetic flux cutting the IC device ground trace, feedback trace, or the positive or negative traces of the output capacitor should be minimized.

Sometimes, locating a trace directly beneath a bobbin inductor will provide good results, provided it is exactly in the center of the inductor (because the induced voltages cancel themselves out), but if it is off center one direction or the other, then problems could arise. If flux problems are present, even the direction of the inductor winding can make a difference in some circuits.

This discussion on open core inductors is not to frighten the user, but to alert the user on what kind of problems to watch out for when using them. Open core bobbin or "stick" inductors are an inexpensive, simple way of making a compact efficient inductor, and they are used by the millions in many different applications.

THERMAL CONSIDERATIONS

The LM2594/LM2594HV is available in two packages, an 8-pin through hole DIP (N) and an 8-pin surface mount SO-8 (M). Both packages are molded plastic with a copper lead frame. When the package is soldered to the PC board, the copper and the board are the heat sink for the LM2594 and the other heat producing components.

For best thermal performance, wide copper traces should be used and all ground and unused pins should be soldered to generous amounts of printed circuit board copper, such as a ground plane (one exception to this is the output (switch) pin, which should not have large areas of copper). Large areas of copper provide the best transfer of heat (lower thermal resistance) to the surrounding air, and even double-sided or multilayer boards provide a better heat path to the surrounding air. Unless power levels are small, sockets are not recommended because of the added thermal resistance it adds and the resultant higher junction temperatures.

Package thermal resistance and junction temperature rise numbers are all approximate, and there are many factors that will affect the junction temperature. Some of these factors include board size, shape, thickness, position, location, and even board temperature. Other factors are, trace width, printed circuit copper area, copper thickness, single- or double-sided, multilayer board, and the amount of solder on the board. The effectiveness of the PC board to dissipate

heat also depends on the size, quantity and spacing of other components on the board. Furthermore, some of these components such as the catch diode will add heat to the PC board and the heat can vary as the input voltage changes. For the inductor, depending on the physical size, type of core material and the DC resistance, it could either act as a heat sink taking heat away from the board, or it could add heat to the board.

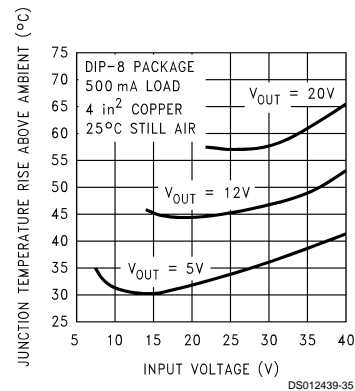

Circuit Data for Temperature Rise Curve (DIP-8)	
Capacitors	Through hole electrolytic
Inductor	Through hole, Schott, 100 μ H
Diode	Through hole, 1A 40V, Schottky
PC board	4 square inches single sided 2 oz. copper (0.0028")

FIGURE 19. Junction Temperature Rise, DIP-8

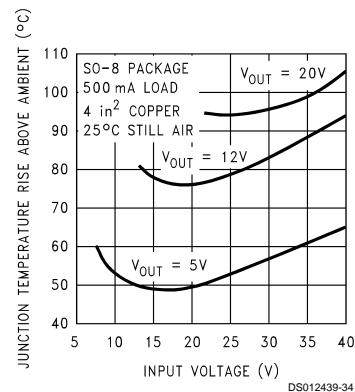

Circuit Data for Temperature Rise Curve (Surface Mount)	
Capacitors	Surface mount tantalum, molded "D" size
Inductor	Surface mount, Coilcraft DO33, 100 μ H
Diode	Surface mount, 1A 40V, Schottky
PC board	4 square inches single sided 2 oz. copper (0.0028")

FIGURE 20. Junction Temperature Rise, SO-8

Application Information (Continued)

The curves shown in *Figure 19* and *Figure 20* show the LM2594 junction temperature rise above ambient temperature with a 500 mA load for various input and output voltages. This data was taken with the circuit operating as a buck switcher with all components mounted on a PC board to simulate the junction temperature under actual operating conditions. This curve is typical, and can be used for a quick check on the maximum junction temperature for various conditions, but keep in mind that there are many factors that can affect the junction temperature.

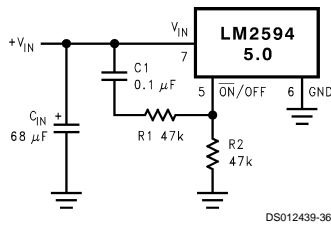

FIGURE 21. Delayed Startup

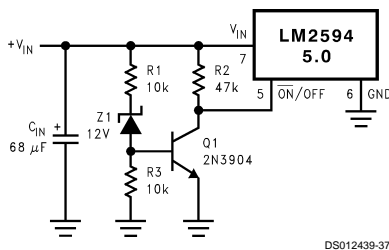
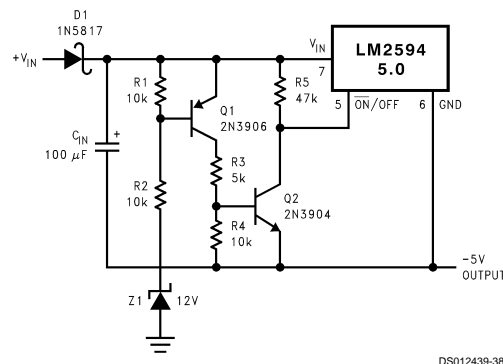

FIGURE 22. Undervoltage Lockout for Buck Regulator



This circuit has an ON/OFF threshold of approximately 13V.

FIGURE 23. Undervoltage Lockout for Inverting Regulator

DELAYED STARTUP

The circuit in *Figure 21* uses the the $\overline{\text{ON}}/\text{OFF}$ pin to provide a time delay between the time the input voltage is applied and the time the output voltage comes up (only the circuitry pertaining to the delayed start up is shown). As the input voltage rises, the charging of capacitor C1 pulls the $\overline{\text{ON}}/\text{OFF}$ pin high, keeping the regulator off. Once the input voltage reaches its final value and the capacitor stops charging, and resistor R₂ pulls the $\overline{\text{ON}}/\text{OFF}$ pin low, thus allowing the circuit to start switching. Resistor R₁ is included to limit the maximum voltage applied to the $\overline{\text{ON}}/\text{OFF}$ pin (maximum of 25V), reduces power supply noise sensitivity, and also limits the capacitor, C1, discharge current. When high input ripple voltage exists, avoid long delay time, because this ripple can be coupled into the $\overline{\text{ON}}/\text{OFF}$ pin and cause problems.

This delayed startup feature is useful in situations where the input power source is limited in the amount of current it can deliver. It allows the input voltage to rise to a higher voltage before the regulator starts operating. Buck regulators require less input current at higher input voltages.

UNDERVOLTAGE LOCKOUT

Some applications require the regulator to remain off until the input voltage reaches a predetermined voltage. An undervoltage lockout feature applied to a buck regulator is shown in *Figure 22*, while *Figure 23* and *Figure 24* applies the same feature to an inverting circuit. The circuit in *Figure 23* features a constant threshold voltage for turn on and turn off (zener voltage plus approximately one volt). If hysteresis is needed, the circuit in *Figure 24* has a turn ON voltage which is different than the turn OFF voltage. The amount of hysteresis is approximately equal to the value of the output voltage. If zener voltages greater than 25V are used, an additional 47k resistor is needed from the $\overline{\text{ON}}/\text{OFF}$ pin to the ground pin to stay within the 25V maximum limit of the $\overline{\text{ON}}/\text{OFF}$ pin.

INVERTING REGULATOR

The circuit in *Figure 25* converts a positive input voltage to a negative output voltage with a common ground. The circuit operates by bootstrapping the regulators ground pin to the negative output voltage, then grounding the feedback pin, the regulator senses the inverted output voltage and regulates it.

Application Information (Continued)

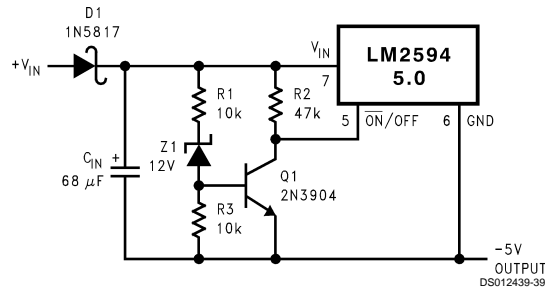

This circuit has hysteresis
Regulator starts switching at $V_{IN} = 13V$
Regulator stops switching at $V_{IN} = 8V$

FIGURE 24. Undervoltage Lockout with Hysteresis for Inverting Regulator

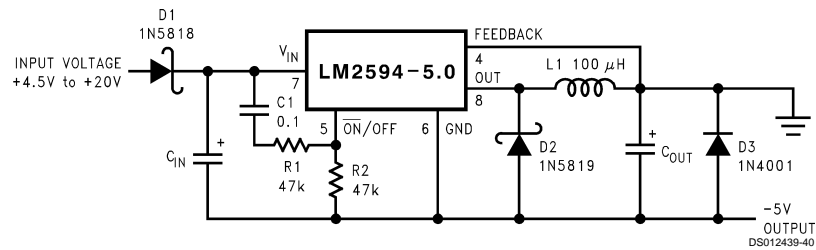

C_{IN} — 68 µF/25V Tant. Sprague 595D
120 µF/35V Elec. Panasonic HFQ
 C_{OUT} — 22 µF/20V Tant. Sprague 595D
39 µF/16V Elec. Panasonic HFQ

FIGURE 25. Inverting -5V Regulator with Delayed Startup

This example uses the LM2594-5 to generate a -5V output, but other output voltages are possible by selecting other output voltage versions, including the adjustable version. Since this regulator topology can produce an output voltage that is either greater than or less than the input voltage, the maximum output current greatly depends on both the input and output voltage. The curve shown in *Figure 26* provides a guide as to the amount of output load current possible for the different input and output voltage conditions.

The maximum voltage appearing across the regulator is the absolute sum of the input and output voltage, and this must be limited to a maximum of 40V. For example, when converting +20V to -12V, the regulator would see 32V between the input pin and ground pin. The LM2594 has a maximum input voltage spec of 40V (60V for the LM2594HV).

Additional diodes are required in this regulator configuration. Diode D1 is used to isolate input voltage ripple or noise from coupling through the C_{IN} capacitor to the output, under light or no load conditions. Also, this diode isolation changes the topology to closely resemble a buck configuration thus providing good closed loop stability. A Schottky diode is recommended for low input voltages, (because of its lower voltage drop) but for higher input voltages, a fast recovery diode could be used.

Without diode D3, when the input voltage is first applied, the charging current of C_{IN} can pull the output positive by several volts for a short period of time. Adding D3 prevents the output from going positive by more than a diode voltage.

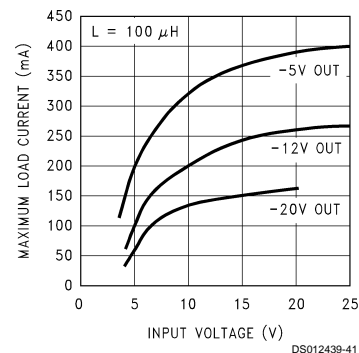

FIGURE 26. Inverting Regulator Typical Load Current

Because of differences in the operation of the inverting regulator, the standard design procedure is not used to select the inductor value. In the majority of designs, a 100 µH, 1A inductor is the best choice. Capacitor selection can also be narrowed down to just a few values. Using the values shown in *Figure 25* will provide good results in the majority of inverting designs.

This type of inverting regulator can require relatively large amounts of input current when starting up, even with light loads. Input currents as high as the LM2594 current limit (approx 0.8A) are needed for at least 2 ms or more, until the out-

Application Information (Continued)

put reaches its nominal output voltage. The actual time depends on the output voltage and the size of the output capacitor. Input power sources that are current limited or sources that can not deliver these currents without getting loaded down, may not work correctly. Because of the relatively high startup currents required by the inverting topology, the delayed startup feature (C_1 , R_1 and R_2) shown in *Figure 25* is recommended. By delaying the regulator startup, the input capacitor is allowed to charge up to a higher voltage before the switcher begins operating. A portion of the high input current needed for startup is now supplied by the input capacitor (C_{IN}). For severe start up conditions, the input capacitor can be made much larger than normal.

INVERTING REGULATOR SHUTDOWN METHODS

To use the \overline{ON}/OFF pin in a standard buck configuration is simple, pull it below 1.3V (@25°C, referenced to ground) to turn regulator ON, pull it above 1.3V to shut the regulator OFF. With the inverting configuration, some level shifting is required, because the ground pin of the regulator is no longer at ground, but is now setting at the negative output voltage level. Two different shutdown methods for inverting regulators are shown in *Figure 27* and *Figure 28*.

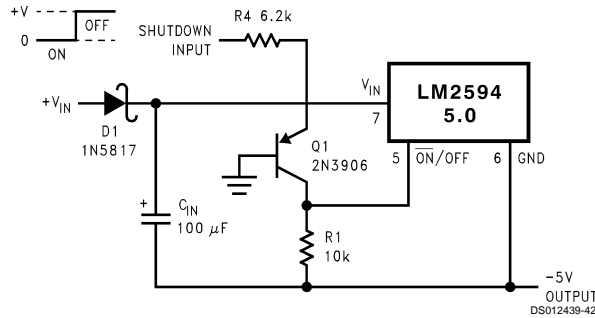

FIGURE 27. Inverting Regulator Ground Referenced Shutdown

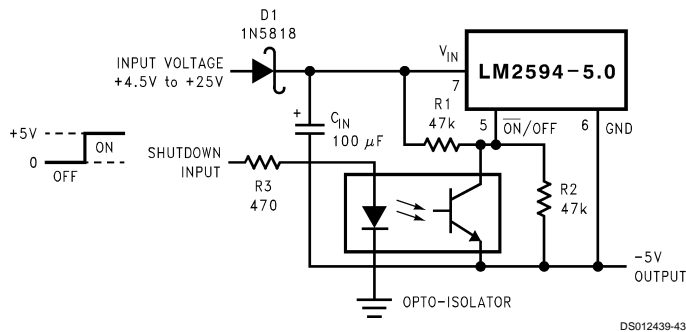
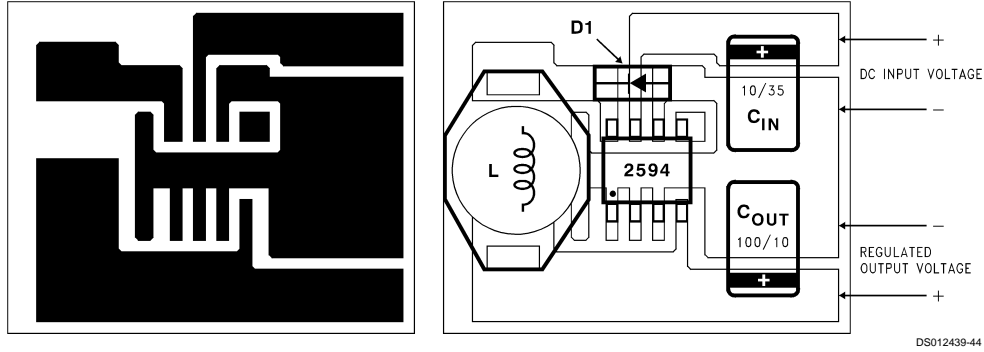

FIGURE 28. Inverting Regulator Ground Referenced Shutdown using Opto Device

Application Information (Continued)

TYPICAL SURFACE MOUNT PC BOARD LAYOUT, FIXED OUTPUT (2X SIZE)



- C_{IN} — 10 μF, 35V, Solid Tantalum AVX, "TPS series"
- C_{OUT} — 100 μF, 10V Solid Tantalum AVX, "TPS series"
- D1 — 1A, 40V Schottky Rectifier, surface mount
- L1 — 100 μH, L20, Coilcraft DO33

TYPICAL SURFACE MOUNT PC BOARD LAYOUT, ADJUSTABLE OUTPUT (2X SIZE)

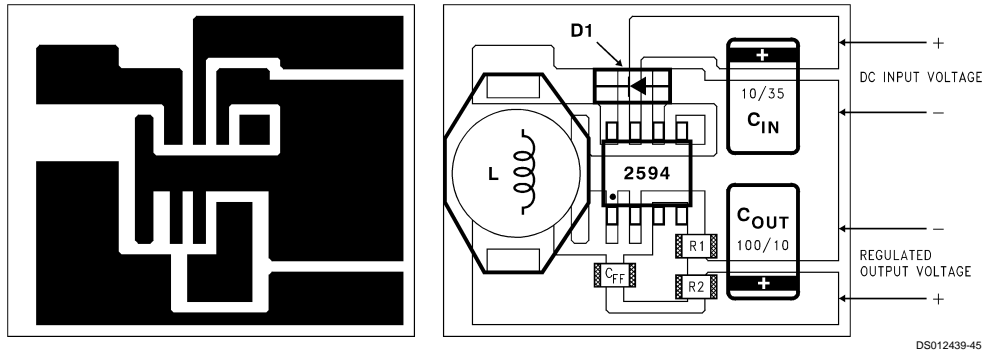

- C_{IN} — 10 μF, 35V, Solid Tantalum AVX, "TPS series"
- C_{OUT} — 100 μF, 10V Solid Tantalum AVX, "TPS series"
- D1 — 1A, 40V Schottky Rectifier, surface mount
- L1 — 100 μH, L20, Coilcraft DO33
- R1 — 1 kΩ, 1%
- R₂ — Use formula in Design Procedure
- C_{FF} — See Figure 3.

FIGURE 29. PC Board Layout

X-ON Electronics

Largest Supplier of Electrical and Electronic Components

Click to view similar products for [Isolated DC/DC Converters](#) category:

Click to view products by [HGSEMI](#) manufacturer:

Other Similar products are found below :

[FMD15.24G](#) [PSL486-7LR](#) [Q48T30020-NBB0](#) [18362](#) [JAHW100Y1](#) [SPB05C-12](#) [SQ24S15033-PS0S](#) [18952](#) [19-130041](#) [CE-1003](#) [CE-1004](#)
[RDS180245](#) [MAU228](#) [J80-0041NL](#) [DFC15U48D15](#) [XGS-1205](#) [NCT1000N040R050B](#) [SPB05B-15](#) [SPB05C-15](#) [L-DA20](#) [DCG40-5G](#)
[QME48T40033-PGB0](#) [AK1601-9RT](#) [DPA423R](#) [VI-R5022-EXWW](#) [PSC128-7iR](#) [RPS8-350ATX-XE](#) [DAS1004812](#) [PQA30-D24-S24-DH](#) [vi-](#)
[m13-cw-03](#) [VI-LN2-EW](#) [VI-PJW01-CZY](#) [CK2540-9ERT](#) [AK-1615-7R](#) [700DNC40-CON-KIT-8G](#) [350DNC40-CON-KIT-9G](#) [088-101348-G](#)
[VI-L52-EW](#) [VI-L53-CV](#) [PQA30-D48-S12-TH](#) [VI-L50-IY](#) [VI-LC63-EV](#) [AM2D-051212DZ](#) [24IBX15-50-0ZG](#) [HZZ01204-G](#) [SPU02L-09](#)
[SPU02M-09](#) [SPU02N-09](#) [UNO-PS/350-900DC/24DC/60W](#) [QUINT4-BUFFER/24DC/20](#)