

LM29152/29302/29502/29752 High-Current Low-Dropout Regulators

General Description

The LM29150/29300/29500/29750 are high current, high accuracy, low-dropout voltage regulators. Using proprietary Super β eta PNP[®] process with a PNP pass element, these regulators feature 350mV to 425mV (full load) typical dropout voltages and very low ground current. Designed for high current loads, these devices also find applications in lower current, extremely low dropout-critical systems, where their tiny dropout voltage and ground current values are important attributes.

The LM29150/29300/29500/29750 are fully protected against overcurrent faults, reversed input polarity, reversed lead insertion, overtemperature operation, and positive and negative transient voltage spikes. Five pin fixed voltage versions feature logic level ON/OFF control and an error flag which signals whenever the output falls out of regulation. Flagged states include low input voltage (dropout), output current limit, overtemperature shutdown, and extremely high voltage spikes on the input.

On the 29xx1 and 29xx2, the ENABLE pin may be tied to VIN if it is not required for ON/OFF control. The LM29150/29300/29500 are available in 3-pin and 5-pin TO-220 and surface mount TO-263 (D²Pak) packages. The 29750 7.5A regulators are available in 3-pin and 5-pin TO-247 packages. The 1.5A, adjustable output 29152 is available in a 5-pin power D-Pak (TO-252) package.

For applications with input voltage 6V or below, see HG37xxx LDOs.

Features

- High current capability
LM29150/29151/29152/29153..... 1.5A
LM29300/29301/29302/29303..... 3A
LM29500/29501/29502/29503..... 5A
- Low-dropout voltage
- Low ground current
- Accurate 1% guaranteed tolerance
- Extremely fast transient response
- Reverse-battery and “Load Dump” protection
- Zero-current shutdown mode (5-pin versions)
- Error flag signals output out-of-regulation (5-pin versions)
- Also characterized for smaller loads with industry-leading performance specifications
- Fixed voltage and adjustable versions

Applications

- Battery powered equipment
- High-efficiency “Green” computer systems
- Automotive electronics
- High-efficiency linear lower supplies
- High-efficiency lost-regulator for switching supply

Typical Application**

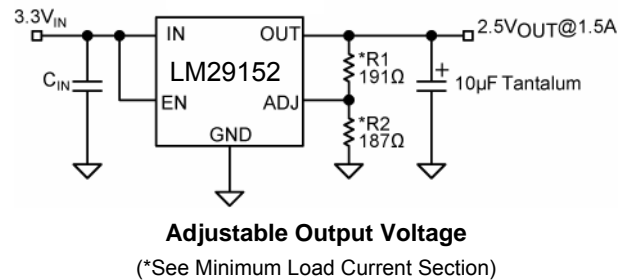
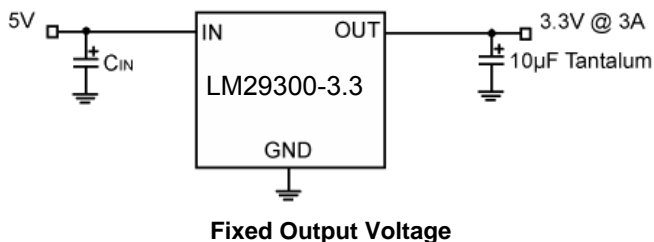

ORDERING INFORMATION

DEVICE	Package Type	MARKING	Packing	Packing Qty
LM29150T-XX	TO220-3L	LM29150-XX	TUBE	1000pcs/box
LM29300T-XX	TO220-3L	LM29300-XX	TUBE	1000pcs/box
LM29500T-XX	TO220-3L	LM29500-XX	TUBE	1000pcs/box
LM29150S-XX/TR	TO263-3L	LM29150-XX	REEL	500pcs/reel
LM29300S-XX/TR	TO263-3L	LM29300-XX	REEL	500pcs/reel
LM29152DT/TR	TO252-5L	LM29152	REEL	2000pcs/reel
LM29151T-XX	TO220-5L	LM29151-XX	TUBE	1000pcs/box
LM29301T-XX	TO220-5L	LM29301-XX	TUBE	1000pcs/box
LM29501T-XX	TO220-5L	LM29501-XX	TUBE	1000pcs/box
LM29751T-XX	TO220-5L	LM29751-XX	TUBE	1000pcs/box
LM29151S-XX/TR	TO263-5L	LM29151-XX	REEL	500pcs/reel
LM29301S-XX/TR	TO263-5L	LM29301-XX	REEL	500pcs/reel
LM29501S-XX/TR	TO263-5L	LM29501-XX	REEL	500pcs/reel
LM29751S-XX/TR	TO263-5L	LM29751-XX	REEL	500pcs/reel
LM29152T	TO220-5L	LM29152	TUBE	1000pcs/box
LM29302T	TO220-5L	LM29302	TUBE	1000pcs/box
LM29502T	TO220-5L	LM29502	TUBE	1000pcs/box
LM29152S/TR	TO263-5L	LM29152	REEL	500pcs/reel
LM29302S/TR	TO263-5L	LM29302	REEL	500pcs/reel
LM29502S/TR	TO263-5L	LM29502	REEL	500pcs/reel
LM29153T	TO220-5L	LM29153	TUBE	1000pcs/box
LM29303T	TO220-5L	LM29303	TUBE	1000pcs/box
LM29503T	TO220-5L	LM29503	TUBE	1000pcs/box
LM29153S/TR	TO263-5L	LM29153	REEL	500pcs/reel
LM29303S/TR	TO263-5L	LM29303	REEL	500pcs/reel
LM29503S/TR	TO263-5L	LM29503	REEL	500pcs/reel

Notes: " xx " may be 1.5V, 1.8V, 2.5V, 3.3V, 5.0V.

Pin Configuration

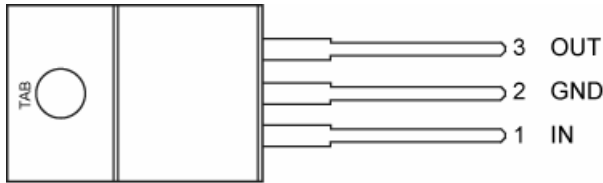

3-Pin TO-220 (T)
LM29150/29300/29500

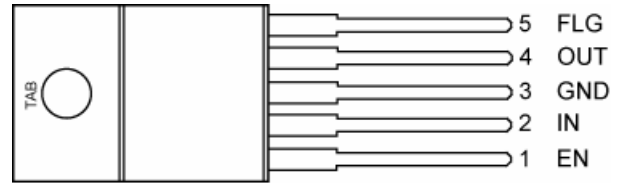

5-Pin TO-220 Fixed Voltage (T)
LM29151/29301/29501/29751

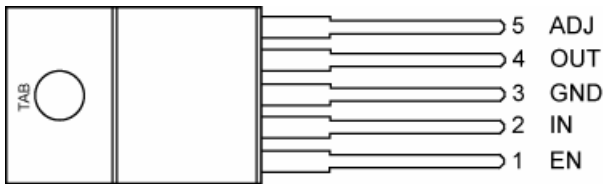

5-Pin TO-220 Adjustable Voltage (T)
LM29152/29302/29502

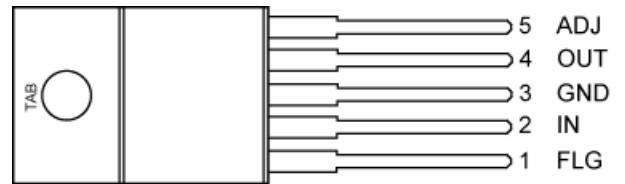

5-Pin TO-220 Adjustable with Flag (T)
LM29153/29303/29503

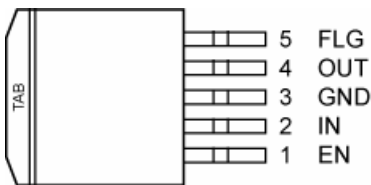

5-Pin TO-263 (D²Pak) Fixed Voltage (U)
LM29151/29301/29501

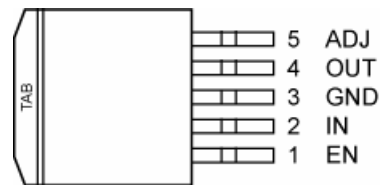

5-Pin TO-263 (D²Pak) Adjustable Voltage (U)
LM29302/29502

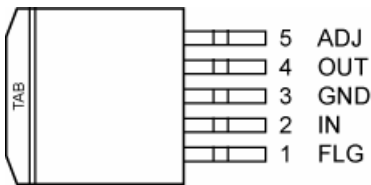

5-Pin TO-263 (D²Pak) Adjustable with Flag (U)
LM29153/29303/29503

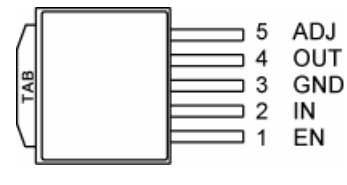

5-Pin TO-252 (D-Pak) Adjustable Voltage (D)
LM29152

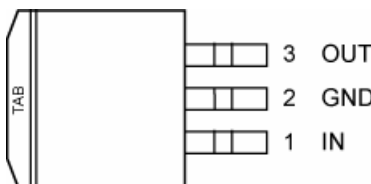

3-Pin TO-263 (D²Pak) (UT)
LM29150/29300

Pin Description

Pin Number TO-220 TO-263	Pin Name
1	INPUT: Supplies the current to the output power device
2	GND: TAB is also connected internally to the IC's ground on D-PAK.
3	OUTPUT: The regulator output voltage

Pin Description

Pin Number Fixed TO-220 TO-263	Pin Number Adjustable TO-220 TO-252 TO-263	Pin Number Adj. with Flag TO-220 TO-263	Pin Name
1	1	—	ENABLE: CMOS compatible control input. Logic high = enable, logic low = shutdown.
2	2	2	INPUT: Supplies the current to the output power device
3, TAB	3, TAB	3, TAB	GND: TAB is also connected internally to the IC's ground on D-PAK.
4	4	4	OUTPUT: The regulator output voltage
—	5	5	ADJUST: Adjustable regulator feedback input that connects to the resistor voltage divider that is placed from OUTPUT to GND in order to set the output voltage.
5	—	1	FLAG: Active low error flag output signal that indicates an output fault condition

Absolute Maximum Ratings⁽¹⁾

Input Supply Voltage (V_{IN}) ⁽¹⁾	7V to +26V
Enable Input Voltage (V_{EN}).....	-0.3V to V_{IN}
Lead Temperature (soldering, 5sec.).....	260°C
Power Dissipation	Internally Limited
Storage Temperature Range	-65°C to +150°C
ESD Rating.....	Note 3

Operating Ratings⁽²⁾

Operating Junction Temperature	-40°C to +125°C
Maximum Operating Input Voltage	26V
Package Thermal Resistance	
TO-220 (θ_{JC}).....	2°C/W
TO-263 (θ_{JC}).....	2°C/W
TO-252 (θ_{JC}).....	3°C/W
TO-252 (θ_{JA})	56°C/W

Electrical Characteristics^(4,13)

$V_{IN} = V_{OUT} + 1V$; $I_{OUT} = 10mA$; $T_J = 25^\circ C$, bold values indicate $-40^\circ C \leq T_J \leq +125^\circ C$, unless noted.

Parameter	Condition	Min	Typ	Max	Units		
Output Voltage	$I_{OUT} = 10mA$	-1		1	%		
	$10mA \leq I_{OUT} \leq I_{FL}$, $(V_{OUT} + 1V) \leq V_{IN} \leq 26V$ ⁽⁵⁾	-2		2	%		
Line Regulation	$I_{OUT} = 10mA$, $(V_{OUT} + 1V) \leq V_{IN} \leq 26V$		0.06	0.5	%		
Load Regulation	$V_{IN} = V_{OUT} + 5V$, $10mA \leq I_{OUT} \leq 1.5A$ ^(5,9)		0.2	1	%		
$\frac{\Delta V_O}{\Delta T}$	Output Voltage ⁽⁹⁾ Temperature Coefficient.		20	100	ppm/°C		
Dropout Voltage	$\Delta V_{OUT} = -1\%$ ⁽⁶⁾ LM29150	$I_{OUT} = 100mA$	80	200	mV		
		$I_{OUT} = 750mA$	220				
	LM29300	$I_{OUT} = 1.5A$	350	600			
		$I_{OUT} = 100mA$	80	175			
	LM29500	$I_{OUT} = 1.5A$	250				
		$I_{OUT} = 3A$	370	600			
	LM29750	$I_{OUT} = 250mA$	125	250			
		$I_{OUT} = 2.5A$	250				
		$I_{OUT} = 5A$	370	600			
		$I_{OUT} = 250mA$	80	200			
	Ground Current	LM29150	$I_{OUT} = 750mA$, $V_{IN} = V_{OUT} + 1V$	8		20	mA
			$I_{OUT} = 1.5A$	22			
LM29300		$I_{OUT} = 1.5A$, $V_{IN} = V_{OUT} + 1V$	10	35	mA		
		$I_{OUT} = 3A$	37				
LM29500		$I_{OUT} = 2.5A$, $V_{IN} = V_{OUT} + 1V$	15	50	mA		
		$I_{OUT} = 5A$	70				
LM29750		$I_{OUT} = 4A$, $V_{IN} = V_{OUT} + 1V$	35	75	mA		
		$I_{OUT} = 7.5A$	120				
I_{GRNDDO} Ground Pin Current at Droupout	$V_{IN} = 0.5V$ less than specified $V_{OUT} \times I_{OUT} = 10mA$ LM29150 LM29300 LM29500 LM29750		0.9		mA		
			1.7		mA		
			2.1		mA		
			3.1		mA		
Current Limit	LM29150	$V_{OUT} = 0V$ ⁽⁷⁾	2.1	3.5	A		
	LM29300	$V_{OUT} = 0V$ ⁽⁷⁾	4.5	5.0	A		
	LM29500	$V_{OUT} = 0V$ ⁽⁷⁾	7.5	10.0	A		
	LM29750	$V_{OUT} = 0V$ ⁽⁷⁾	9.5	15	A		

Parameter	Condition	Min	Typ	Max	Units
e _n , Output Noise Voltage (10Hz to 100kHz) I _L = 100mA	C _L = 10μF		400		μV (rms)
	C _L = 33μF		260		
Ground Current in Shutdown	29150/1/2/3 only V _{EN} = 0.4V		2	10 30	μA μA
Reference LM29xx2/29xx3					
Reference Voltage		1.228	1.240	1.252	V
		1.215		1.265	
Reference Voltage		1.203		1.277	V
Adjust Pin Bias Current			40	80 120	nA
Reference Voltage Temperature Coefficient	⁽¹⁰⁾		20		ppm°C
Adjust Pin Bias Current Temperature Coefficient			0.1		nA/°C
Flag Output (Error Comparator) LM29xx1/29xx3					
Output Leakage Current	V _{OH} = 26V		0.01	1.00 2.00	μA
Output Low Voltage	Device set for 5V, V _{IN} = 4.5V I _{OL} = 250μA		220	300 400	mV
Upper Threshold Voltage	Device set for 5V ⁽¹¹⁾	40 25	60		mV
Lower Threshold Voltage	Device set for 5V ⁽¹¹⁾		75	95 140	mV
Hysteresis	Device set for 5V ⁽¹¹⁾		15		mV
ENABLE Input LM29xx1/29xx2					
Input Logic Voltage Low (OFF) High (ON)		2.4		0.8	V
Enable Pin Input Current	V _{EN} = 26V		100	600 750	μA
	V _{EN} = 0.8V	0.7		2 4	μA
Regulator Output Current in Shutdown	⁽¹²⁾		10	500	μA

Notes:

1. Maximum positive supply voltage of 26V must be of limited duration (<100msec) and duty cycle ($\leq 1\%$). The maximum continuous supply voltage is 26V. Exceeding the absolute maximum rating may damage the device.
2. The device is not guaranteed to function outside its operating rating.
3. Devices are ESD sensitive. Handling precautions recommended.
4. Specification for packaged product only.
5. Full load current (I_{FL}) is defined as 1.5A for the LM29150, 3A for the LM29300, 5A for the LM29500, and 7.5A for the LM29750 families.
6. Dropout voltage is defined as the input-to-output differential when the output voltage drops to 99% of its normal value with $V_{OUT} + 1V$ applied to V_{IN} .
7. $V_{IN} = V_{OUT(nominal)} + 1V$. For example, use $V_{IN} = 4.3V$ for a 3.3V regulator or use 6V for a 5V regulator. Employ pulse-testing procedures to pin current.
8. Ground pin current is the regulator quiescent current. The total current drawn from the source is the sum of the load current plus the ground pin current.
9. Output voltage temperature coefficient is defined as the worst case voltage change divided by the total temperature range.
10. Thermal regulation is defined as the change in output voltage at a time T after a change in power dissipation is applied, excluding load or line regulation effects. Specifications are for a 200mA load pulse at $V_{IN} = 20V$ (a 4W pulse) for $T = 10ms$.
11. Comparator thresholds are expressed in terms of a voltage differential at the Adjust terminal below the nominal reference voltage measured at 6V input. To express these thresholds in terms of output voltage change, multiply by the error amplifier gain $= V_{OUT}/V_{REF} = (R1 + R2)/R2$. For example, at a programmed output voltage of 5V, the Error output is guaranteed to go low when the output drops by $95mV \times 5V/1.240V = 384mV$. Thresholds remain constant as a percent of V_{OUT} as V_{OUT} is varied, with the dropout warning occurring at typically 5% below nominal, 7.7% guaranteed.
12. $V_{EN} \leq 0.8V$ and $V_{IN} \leq 26V$, $V_{OUT} = 0$.
13. When used in dual supply systems where the regulator load is returned to a negative supply, the output voltage must be diode clamped to ground.

Typical Characteristics LM2915x

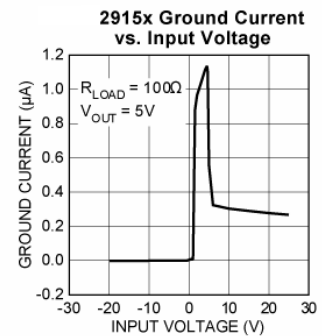
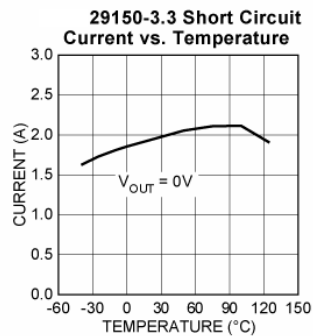
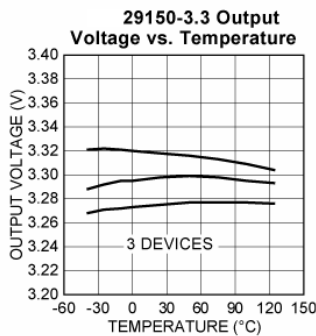
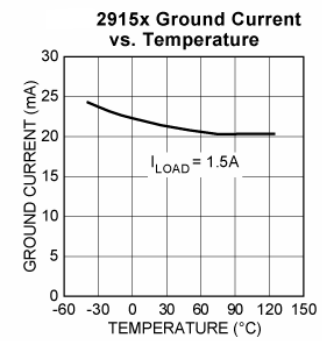
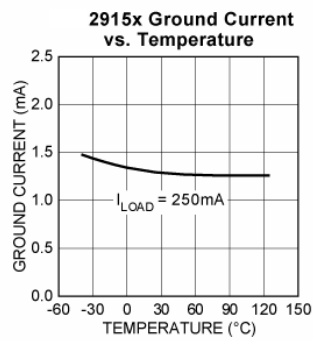
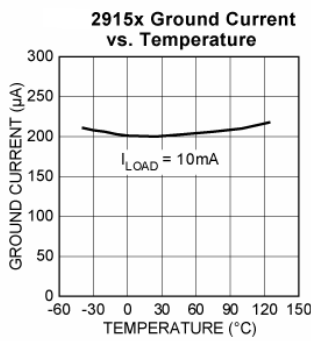
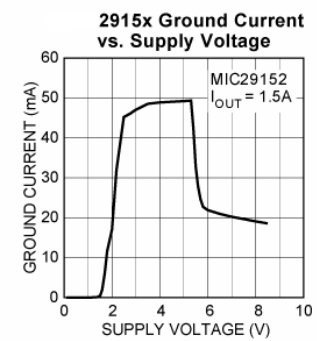
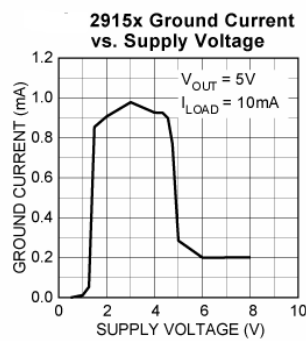
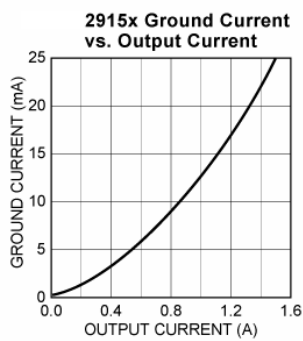
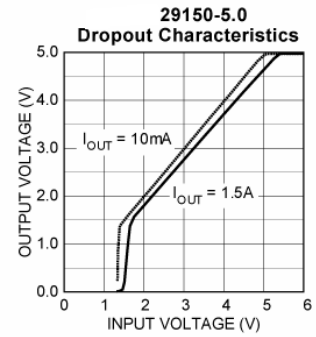
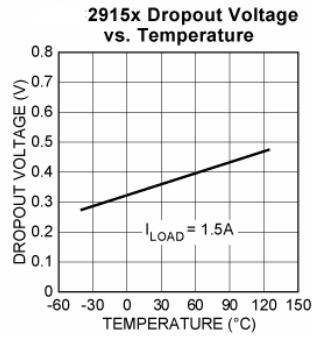
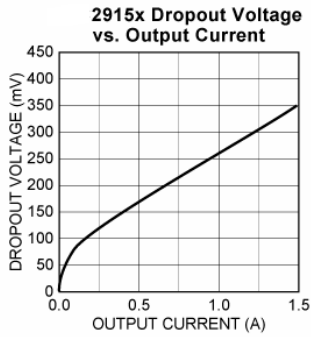

29151-xx/2 Enable Current vs. Temperature

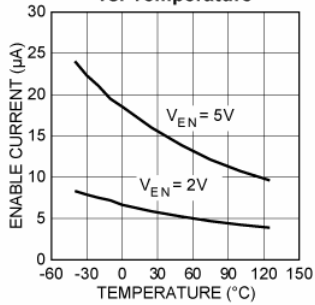

2915x Load Transient

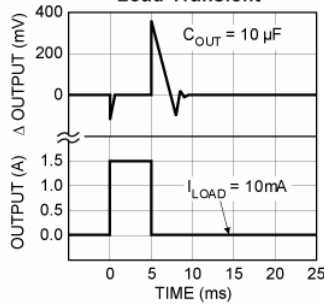

2915x Load Transient

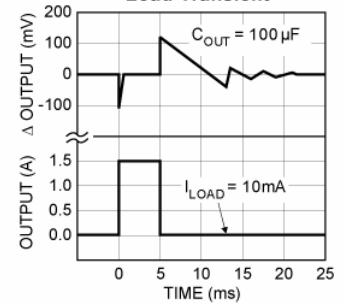

29152/3 Adjust Pin Current vs. Temperature

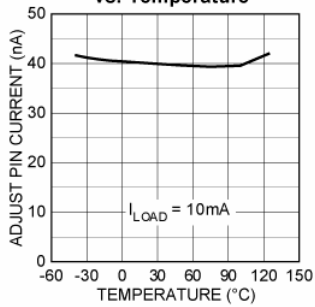

2915x Line Transient

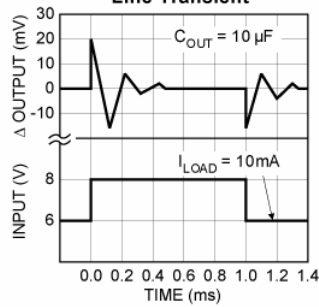

2915x Line Transient

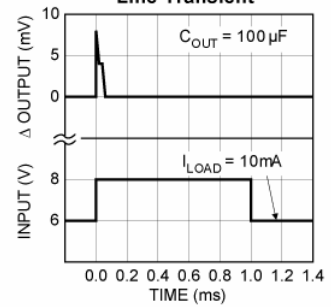

2915x Output Impedance vs. Frequency

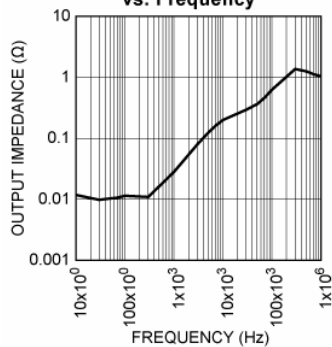

29152 Ground Current vs. Temperature

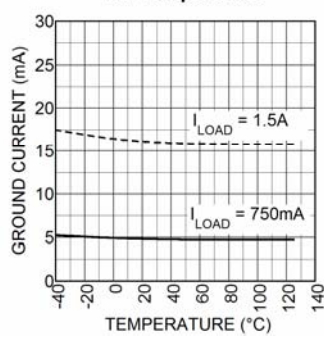

29152 Dropout Voltage vs. Output Current

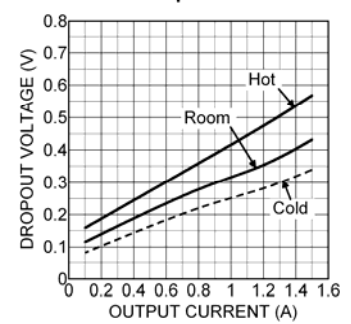

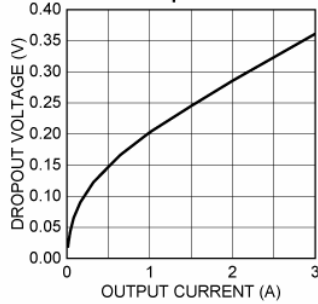
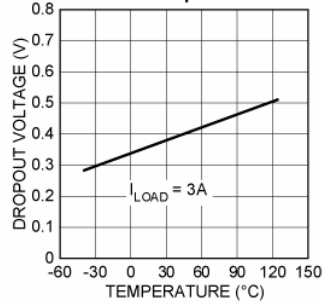
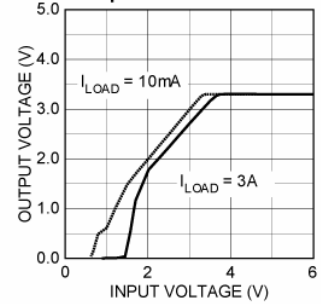
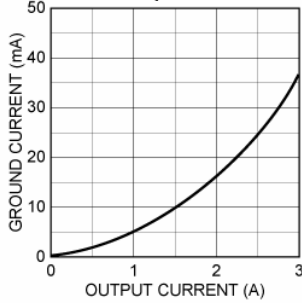
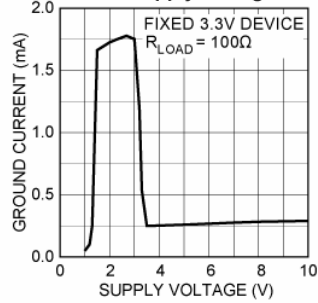
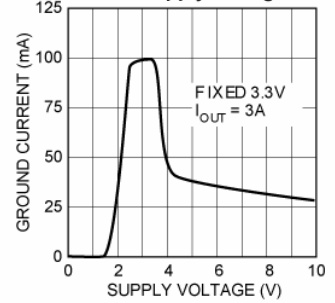
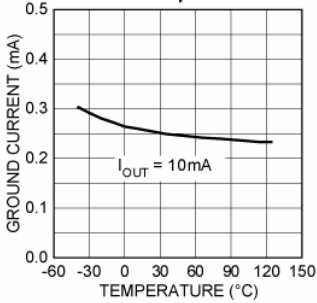
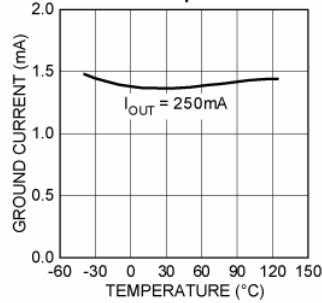
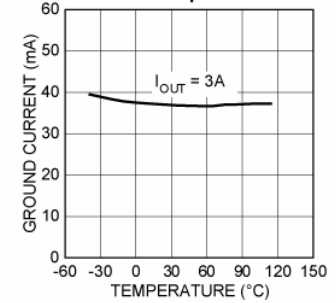
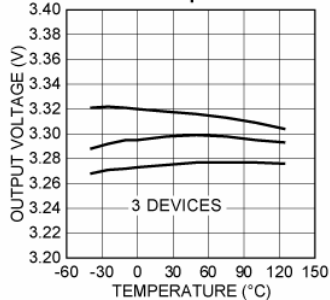
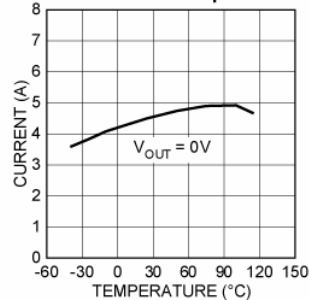
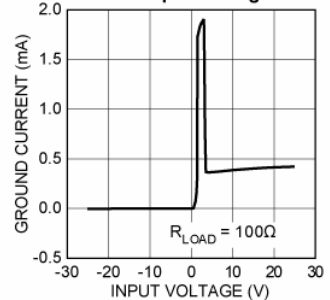
Typical Characteristics LM2930x
2930x Dropout Voltage vs. Output Current

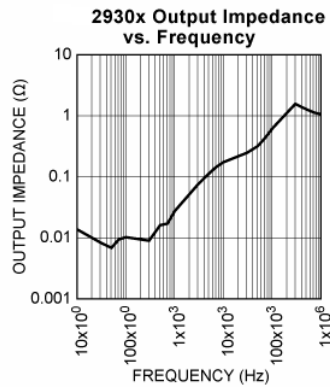
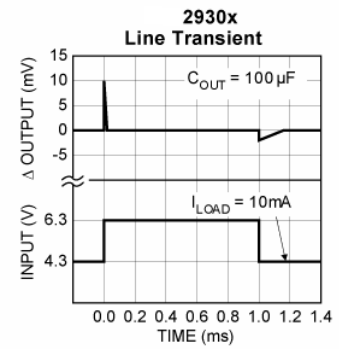
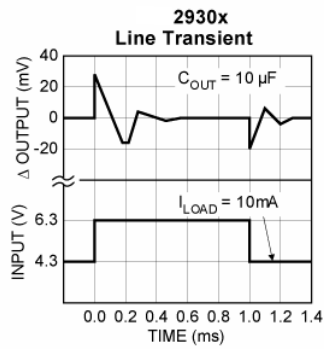
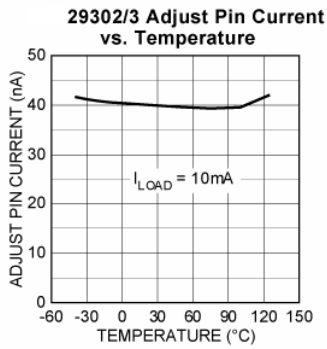
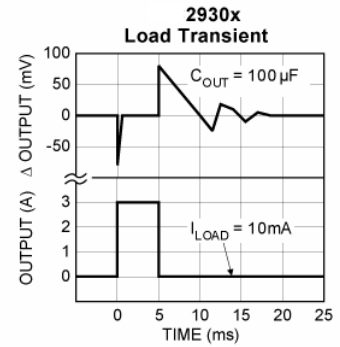
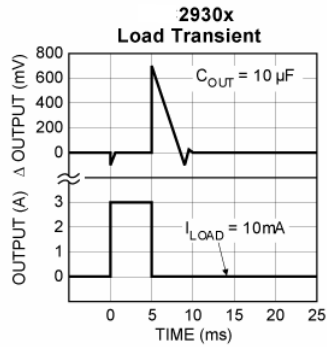
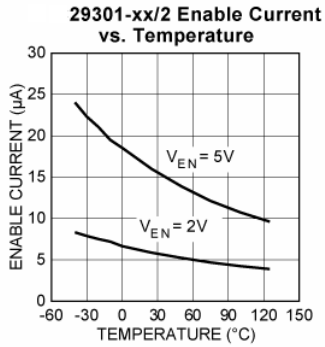
2930x Dropout Voltage vs. Temperature

29300-3.3 Dropout Characteristics

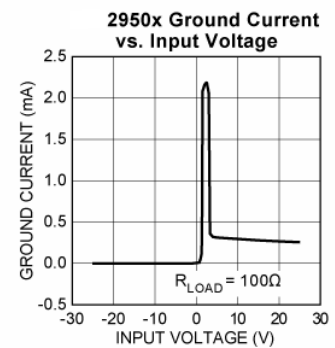
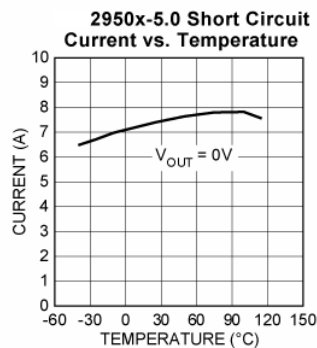
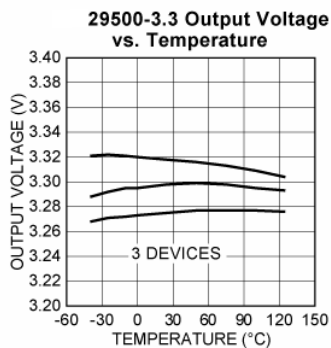
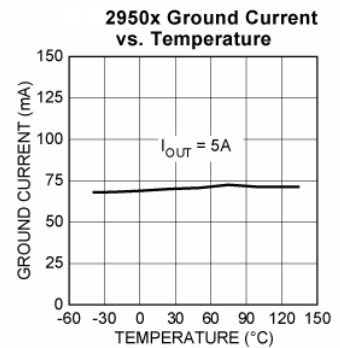
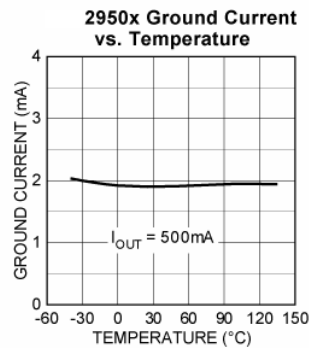
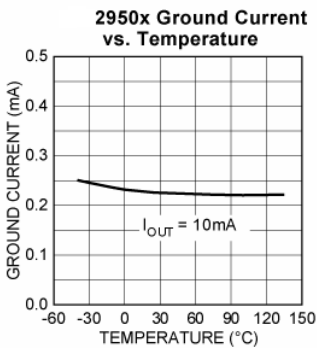
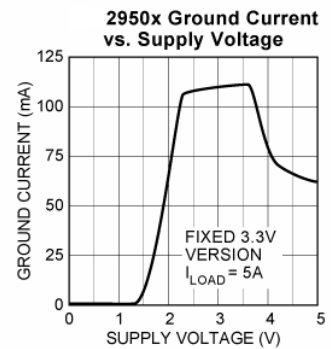
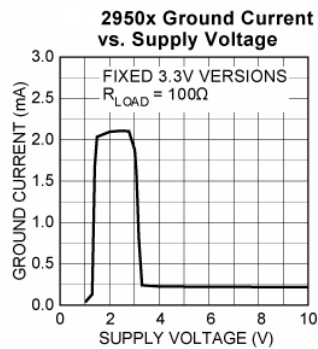
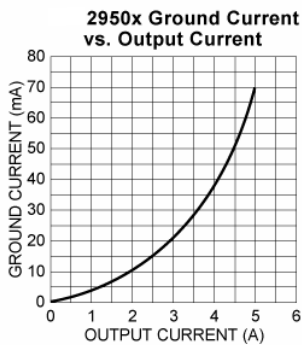
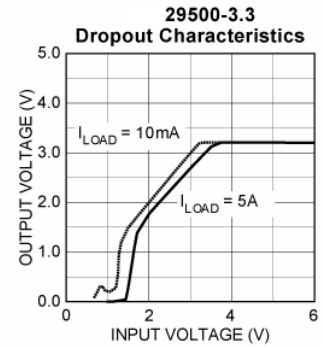
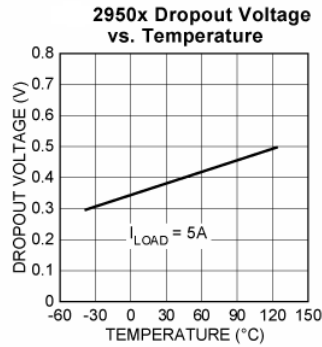
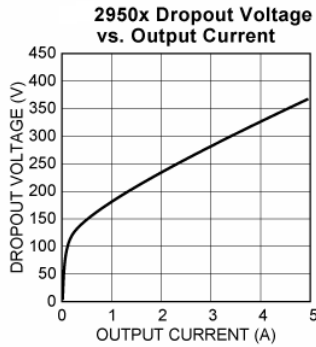
2930x Ground Current vs. Output Current

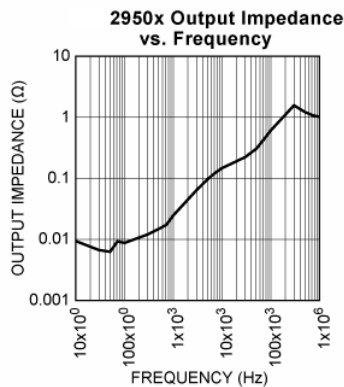
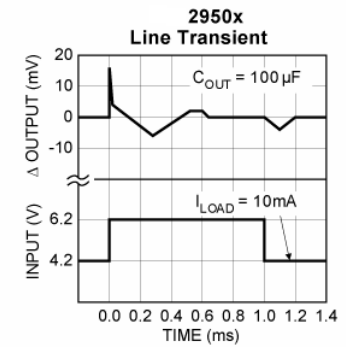
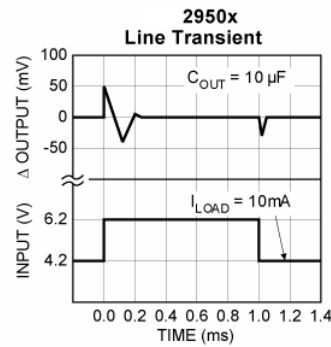
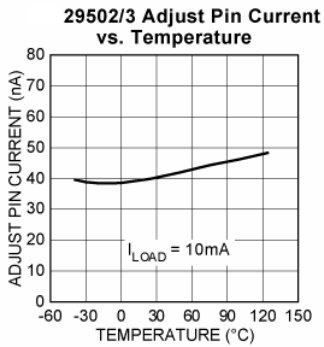
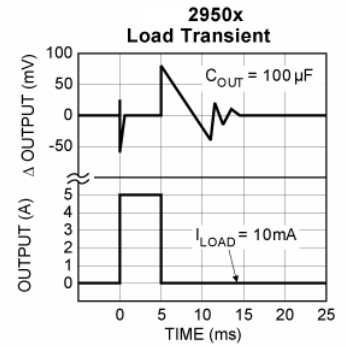
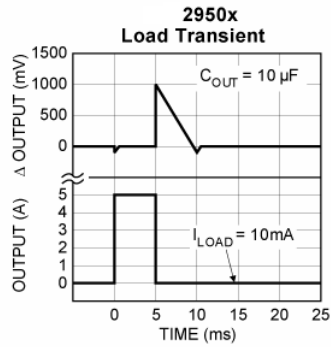
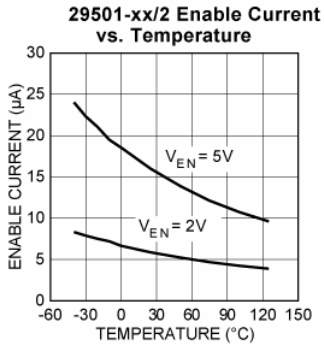
2930x Ground Current vs. Supply Voltage

2930x Ground Current vs. Supply Voltage

2930x Ground Current vs. Temperature

2930x Ground Current vs. Temperature

2930x Ground Current vs. Temperature

29300-3.3 Output Voltage vs. Temperature

29300-5.0 Short Circuit Current vs. Temperature

2930x Ground Current vs. Input Voltage



Typical Characteristics LM2950x





Typical Characteristics LM2975x

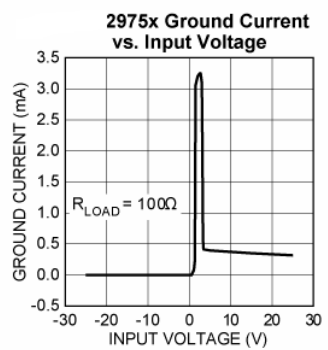
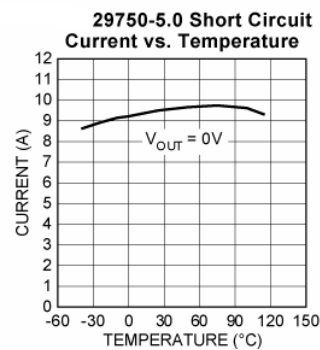
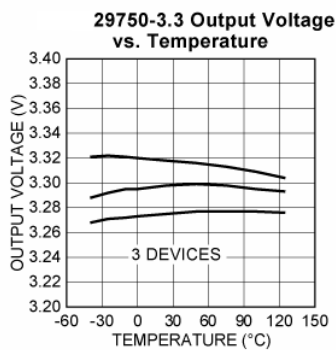
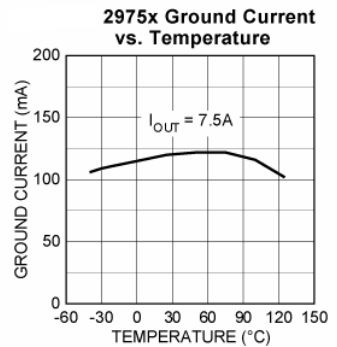
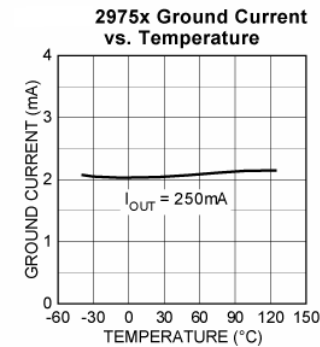
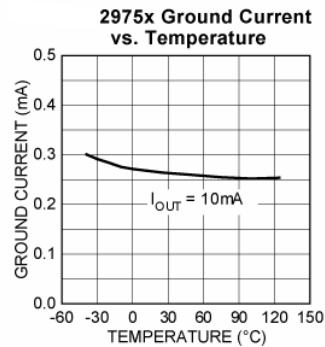
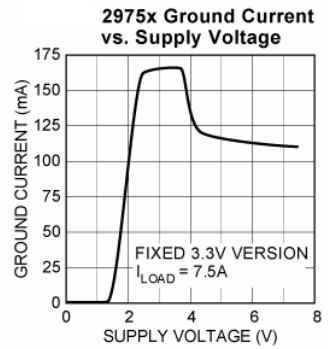
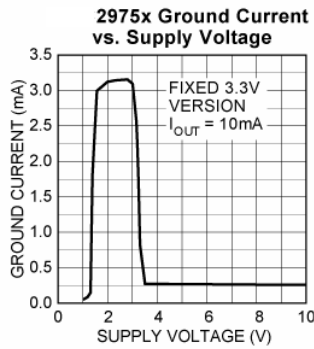
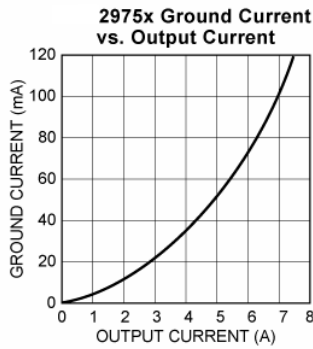
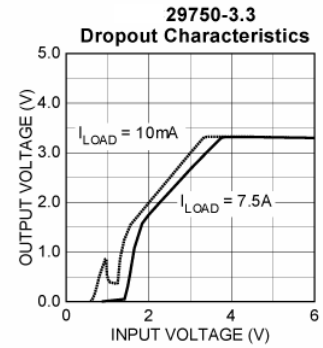
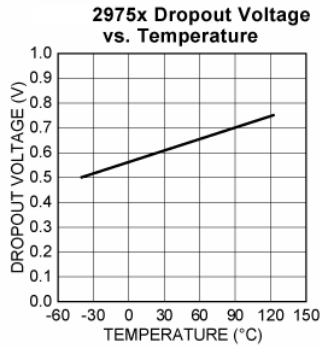
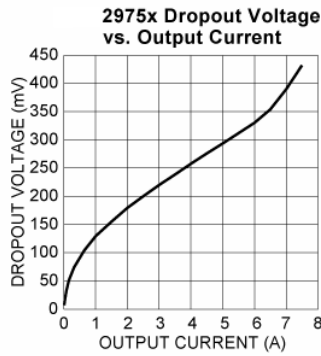

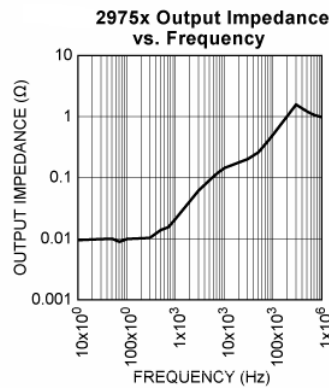
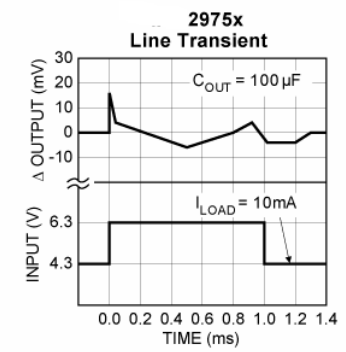
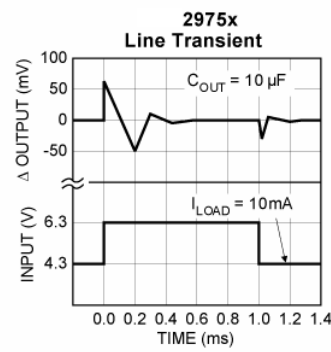
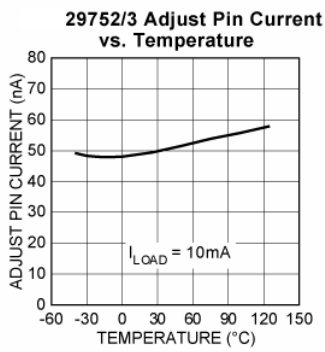
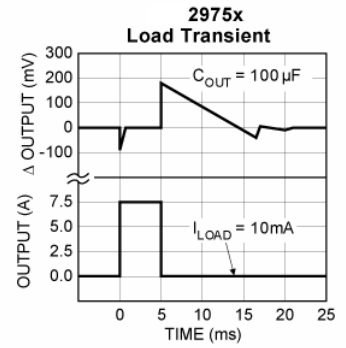
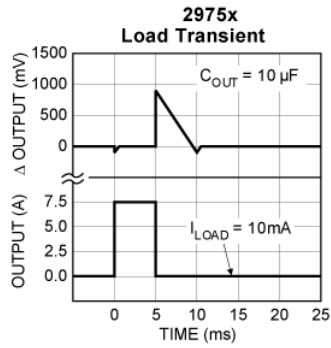
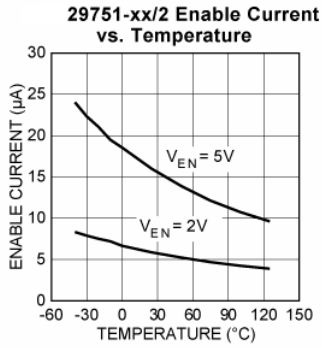

Functional Diagram

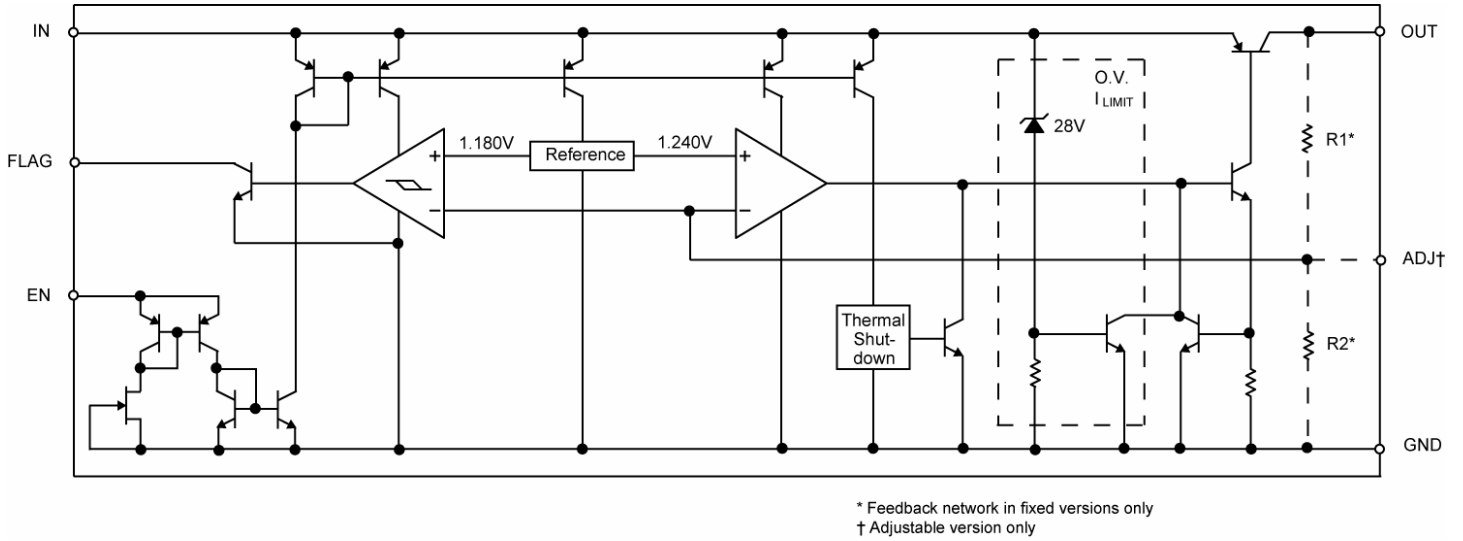

Application Information

The LM29150/29300/29500/29750 are high performance low-dropout voltage regulators suitable for all moderate to high-current voltage regulator applications. Their 350mV to 425mV typical dropout voltage at full load make them especially valuable in battery powered systems and as high efficiency noise filters in “post-regulator” applications. Unlike older NPN-pass transistor designs, where the minimum dropout voltage is limited by the base-emitter voltage drop and collector-emitter saturation voltage, dropout performance of the PNP output of these devices is limited merely by the low V_{CE} saturation voltage.

A trade-off for the low-dropout voltage is a varying base driver requirement. But Super β PNP[®] process reduces this drive requirement to merely 1% of the load current.

The LM29150/29300/29500/29750 family of regulators are fully protected from damage due to fault conditions. Current limiting is provided. This limiting is linear; output current under overload conditions is constant. Thermal shutdown disables the device when the die temperature exceeds the 125°C maximum safe operating temperature. Transient protection allows device (and load) survival even when the input voltage spikes between +7V and +26V. When the input voltage exceeds about 20V to 26V, the over voltage sensor temporarily disables the regulator. The output structure of these regulators allows voltages in excess of the desired output voltage to be applied without reverse current flow. LM29xx1 and LM29xx2 versions offer a logic level ON/OFF control: when disabled, the devices draw nearly zero current.

An additional feature of this regulator family is a common pinout: a design’s current requirement may change up or down yet use the same board layout, as all of these regulators have identical pinouts.

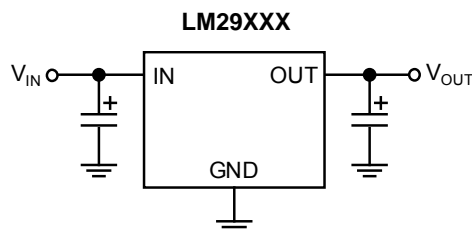

Figure 3. Linear regulators require only two capacitors for operation.

Thermal Design

Linear regulators are simple to use. The most complicated design parameters to consider are thermal characteristics. Thermal design requires the following application-specific parameters:

- Maximum ambient temperature, T_A

- Output Current, I_{OUT}
- Output Voltage, V_{OUT}
- Input Voltage, V_{IN}

First, we calculate the power dissipation of the regulator from these numbers and the device parameters from this datasheet.

$$P_D = I_{OUT}(1.01 V_{IN} - V_{OUT})$$

Where the ground current is approximated by 1% of I_{OUT} . Then the heat sink thermal resistance is determined with this formula:

$$\theta_{SA} = \frac{T_{JMAX} - T_A}{P_D} - (\theta_{JC} + \theta_{CS})$$

Where $T_{JMAX} \leq 125^\circ\text{C}$ and θ_{CS} is between 0 and 2°C/W .

The heat sink may be significantly reduced in applications where the minimum input voltage is known and is large compared with the dropout voltage. Use a series input resistor to drop excessive voltage and distribute the heat between this resistor and the regulator. The low-dropout properties of Super β PNP[®] regulators allow very significant reductions in regulator power dissipation and the associated heat sink without compromising performance. When this technique is employed, a capacitor of at least 0.1 μF is needed directly between the input and regulator ground.

Please refer to Application Note 9 and Application Hint 17 for further details and examples on thermal design and heat sink specification.

With no heat sink in the application, calculate the junction temperature to determine the maximum power dissipation that will be allowed before exceeding the maximum junction temperature of the 29152. The maximum power allowed can be calculated using the thermal resistance (θ_{JA}) of the D-Pak adhering to the following criteria for the PCB design: 2 oz. copper and 100mm² copper area for the 29152.

For example, given an expected maximum ambient temperature (T_A) of 75°C with $V_{IN} = 3.3\text{V}$, $V_{OUT} = 2.5\text{V}$, and $I_{OUT} = 1.5\text{A}$, first calculate the expected P_D using Equation (1);

$$P_D = (3.3\text{V} - 2.5\text{V})1.5\text{A} - (3.3\text{V})(0.016\text{A}) = 1.1472\text{W}$$

Next, calculate the junction temperature for the expected power dissipation.

$$T_J = (\theta_{JA} \times P_D) + T_A = (56^\circ\text{C/W} \times 1.1472\text{W}) + 75^\circ\text{C} = 139.24^\circ\text{C}$$

Now determine the maximum power dissipation allowed that would not exceed the IC’s maximum junction temperature (125°C) without the use of a heat sink by

$$P_{D(MAX)} = (T_{J(MAX)} - T_A) / \theta_{JA} = (125^\circ\text{C} - 75^\circ\text{C}) / (56^\circ\text{C/W}) = 0.893\text{W}$$

Capacitor Requirements

For stability and minimum output noise, a capacitor on the regulator output is necessary. The value of this capacitor is dependent upon the output current; lower currents allow smaller capacitors.

This capacitor need not be an expensive low ESR type: aluminum electrolytics are adequate. In fact, extremely low ESR capacitors may contribute to instability. Tantalum capacitors are recommended for systems where fast load transient response is important.

Where the regulator is powered from a source with a high AC impedance, a 0.1μF capacitor connected between Input and GND is recommended. This capacitor should have good characteristics to above 250kHz.

Minimum Load Current

The LM29150–29750 regulators are specified between finite loads. If the output current is too small, leakage currents dominate and the output voltage rises. The following minimum load current swamps any expected leakage current across the operating temperature range:

Device	Minimum Load
29150.....	5mA
29300.....	7mA
29500.....	10mA
29750.....	10mA

Adjustable Regulator Design

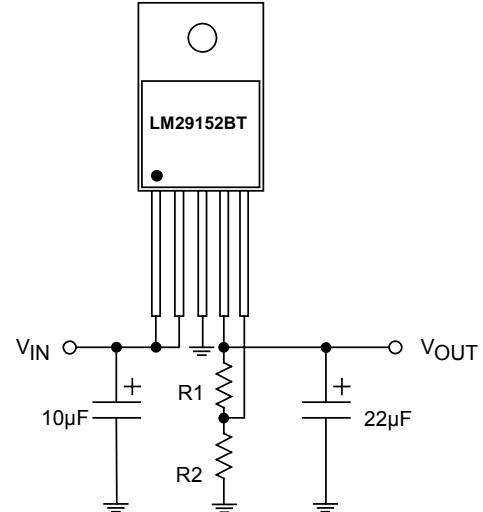

Figure 4. Adjustable Regulator with Resistors

The adjustable regulator versions, LM29xx2 and LM29xx3, allow programming the output voltage anywhere between 1.25V and the 25V. Two resistors are used. The resistor values are calculated by:

$$R_1 = R_2 \times \left(\frac{V_{OUT}}{1.240} - 1 \right)$$

where V_{OUT} is the desired output voltage. Figure 4 shows component definition. Applications with widely varying load currents may scale the resistors to draw the minimum load current required for proper operation (see “Minimum Load Current” section).

Error Flag

LM29xx1 and LM29xx3 versions feature an Error Flag, which looks at the output voltage and signals an error condition when this voltage drops 5% below its expected value. The error flag is an open-collector output that pulls low under fault conditions. It may sink 10mA. Low output voltage signifies a number of possible problems, including an overcurrent fault (the device is in current limit) and low input voltage. The flag output is inoperative during overtemperature shutdown conditions.

Enable Input

LM29xx1 and LM29xx2 versions feature an enable (EN) input that allows ON/OFF control of the device. Special design allows “zero” current drain when the device is disabled—only microamperes of leakage current flows. The EN input has TTL/CMOS compatible thresholds for simple interfacing with logic, or may be directly tied to $\leq 26V$. Enabling the regulator requires approximately 20μA of current.

PACKAGE

T0263-5-A2

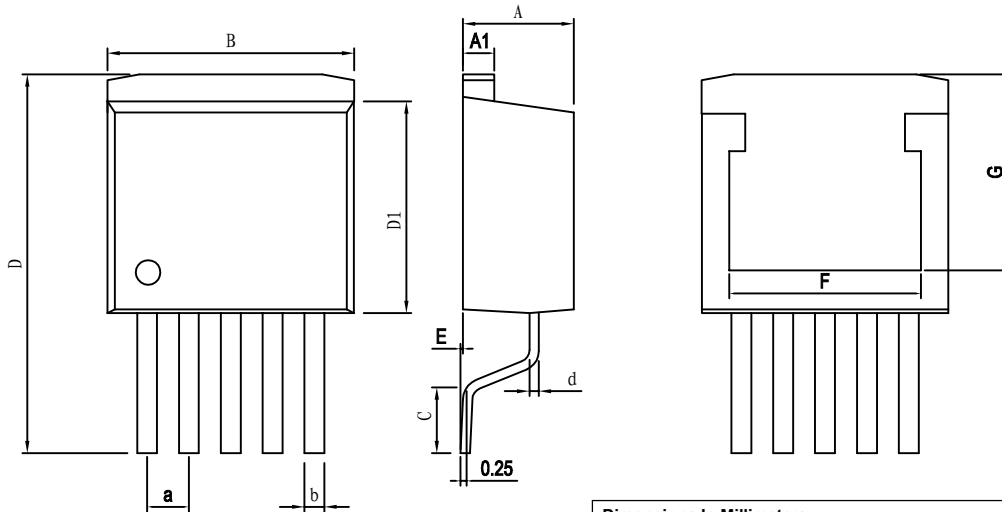

Dimensions In Millimeters					
Symbol :	Min :	Max :	Symbol :	Min :	Max :
A	4.400	4.600	E	0	0.305
A1	1.250	1.300	F	7.80 TYP	
B	9.800	10.41	G	7.97 TYP	
C	2.100	2.600	a	1.680	1.720
D	14.750	15.650	b	0.710	0.910
D1	8.450	8.950			

T0220-5-A2

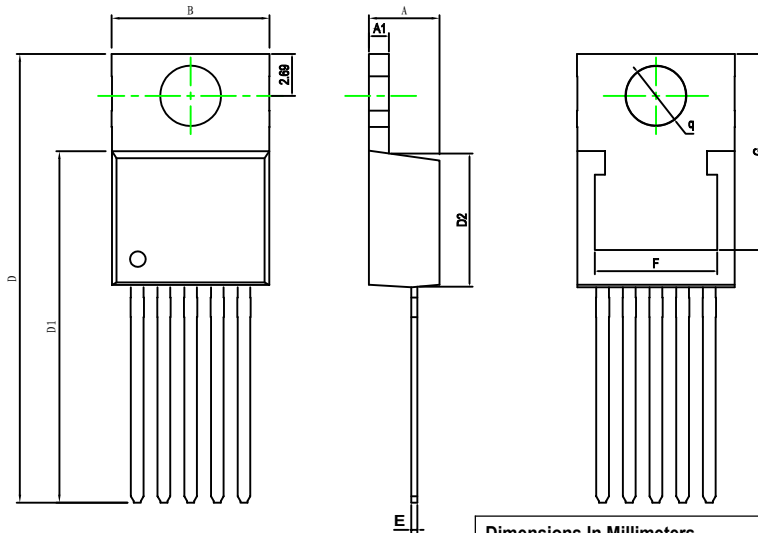

Dimensions In Millimeters					
Symbol :	Min :	Max :	Symbol :	Min :	Max :
A	4.400	4.600	D1	8.450	8.950
A1	1.250	1.300	E	0.330	0.430
B	9.850	10.41	F	7.80 TYP	
D	28.60	28.85	G	12.62 TYP	
D1	22.45	22.75	q	3.84 TYP	

PACKAGE

T0252-5

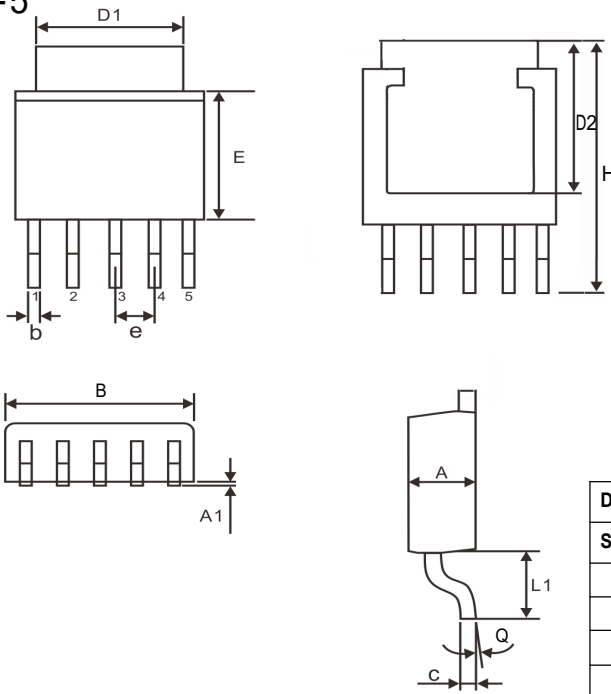

Dimensions In Millimeters					
Symbol :	Min :	Max :	Symbol :	Min :	Max :
A	2.100	2.500	L1	3.100	3.200
A1	0.000	0.300	Q	0°	8°
B	6.400	6.600	b	0.550	0.660
C	0.490	0.560	e	1.143	1.379
E	5.800	6.200	D1	5.300 TYP	
H	9.200	10.200	D2	5.415 TYP	

Important statement:

Huaguan Semiconductor Co,Ltd. reserves the right to change the products and services provided without notice. Customers should obtain the latest relevant information before ordering, and verify the timeliness and accuracy of this information.

Customers are responsible for complying with safety standards and taking safety measures when using our products for system design and machine manufacturing to avoid potential risks that may result in personal injury or property damage.

Our products are not licensed for applications in life support, military, aerospace, etc., so we do not bear the consequences of the application of these products in these fields.

Our documentation is only permitted to be copied without any tampering with the content, so we do not accept any responsibility or liability for the altered documents.

X-ON Electronics

Largest Supplier of Electrical and Electronic Components

Click to view similar products for [LDO Voltage Regulators](#) category:

Click to view products by [HGSEMI](#) manufacturer:

Other Similar products are found below :

[AP7363-SP-13](#) [L79M05TL-E](#) [AP7362-HA-7](#) [PT7M8202B12TA5EX](#) [TCR3DF185,LM\(CT](#) [TCR3DF45,LM\(CT](#) [TLE4473G V52](#) [059985X](#)
[NCP4687DH15T1G](#) [701326R](#) [NCV8170AXV250T2G](#) [AP7315-25W5-7](#) [AP2111H-1.2TRG1](#) [ZLDO1117QK50TC](#) [AZ1117ID-ADJTRG1](#)
[TCR3DG12,LF](#) [MIC5514-3.3YMT-T5](#) [SCD7912BTG](#) [NCP154MX180270TAG](#) [SCD33269T-5.0G](#) [NCV8170BXV330T2G](#)
[NCV8170BMX330TCG](#) [NCV8170AMX120TCG](#) [NCP706ABMX300TAG](#) [NCP153MX330180TCG](#) [NCP114BMX075TCG](#) [MC33269T-3.5G](#)
[TCR3DG33,LF](#) [TCR4DG35,LF](#) [TAR5S15U\(TE85L,F\)](#) [TAR5S18U\(TE85L,F\)](#) [TCR3UG19A,LF](#) [TCR4DG105,LF](#) [MPQ2013AGG-5-P](#)
[NCV8170AMX360TCG](#) [TLE4268GSXUMA2](#) [NCP715SQ15T2G](#) [MIC5317-3.0YD5-T5](#) [NCV563SQ18T1G](#) [NCP715MX30TBG](#)
[NCV8702MX25TCG](#) [NCV8170BXV120T2G](#) [MIC5317-1.2YD5-T5](#) [NCV8170AMX150TCG](#) [NCV8170BMX150TCG](#) [AP2213D-3.3TRG1](#)
[NCV8170BMX120TCG](#) [NCV8170BMX310TCG](#) [NCV8170BMX360TCG](#) [MIC5514-1.2YMT-T5](#)