

## 500mA Low Dropout Regulator

### Features

- Fully Specified for Operation Over  $-40^{\circ}\text{C}$  to  $125^{\circ}\text{C}$  .
- Output Current in Excess of 500 mA.
- Output Trimmed for 5% Tolerance Under all Operating Conditions.
- Typical Dropout Voltage of 0.5 V at Full Rated Load Current.
- Wide Output Capacitor ESR Range, up to  $3\Omega$ .
- Internal Short Circuit and Thermal Overload Protection.
- Reverse Battery Protection.
- 60-V Input Transient Protection.
- Mirror Image Insertion Protection .

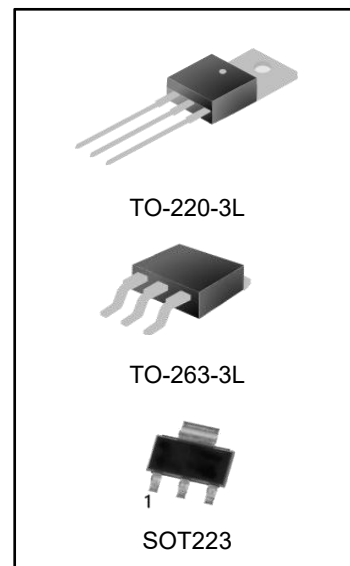

### Ordering Information

DEVICE	Package Type	MARKING	Packing	Packing Qty
LM2937ET-5.0	TO220-3	LM2937E-5.0	TUBE	1000pcs/Box
LM2937ET-8.0	TO220-3	LM2937E-8.0	TUBE	1000pcs/Box
LM2937ET-10	TO220-3	LM2937E-10	TUBE	1000pcs/Box
LM2937ET-12	TO220-3	LM2937E-12	TUBE	1000pcs/Box
LM2937ET-15	TO220-3	LM2937E-15	TUBE	1000pcs/Box
LM2937ES-5.0/TR	TO263-3	LM2937E-5.0	REEL	500pcs/Reel
LM2937ES-8.0/TR	TO263-3	LM2937E-8.0	REEL	500pcs/Reel
LM2937ES-10/TR	TO263-3	LM2937E-10	REEL	500pcs/Reel
LM2937ES-12/TR	TO263-3	LM2937E-12	REEL	500pcs/Reel
LM2937ES-15/TR	TO263-3	LM2937E-15	REEL	500pcs/Reel
LM2937EMP-5.0/TR	SOT223	L71B	REEL	2500pcs/Reel
LM2937EMP-8.0/TR	SOT223	L72B	REEL	2500pcs/Reel
LM2937EMP-10/TR	SOT223	L73B	REEL	2500pcs/Reel
LM2937EMP-12/TR	SOT223	L74B	REEL	2500pcs/Reel
LM2937EMP-15/TR	SOT223	L75B	REEL	2500pcs/Reel

## Description

The LM2937 is a positive voltage regulator capable of supplying up to 500 mA of load current. The use of a PNP power transistor provides a low dropout voltage characteristic. With a load current of 500 mA the minimum input to output voltage differential required for the output to remain in regulation is typically 0.5 V (1-V ensured maximum over the full operating temperature range). Special circuitry has been incorporated to minimize the quiescent current to typically only 10 mA with a full 500-mA load current when the input to output voltage differential is greater than 3 V.

The LM2937 requires an output bypass capacitor for stability. As with most low dropout regulators, the ESR of this capacitor remains a critical design parameter, but the LM2937 includes special compensation circuitry that relaxes ESR requirements. The device is stable for all ESR below 3  $\Omega$ . This allows the use of low ESR chip capacitors. Ideally suited for automotive applications, the LM2937 will protect itself and any load circuitry from reverse battery connections, two-battery jumps, and up to 60-V/-50-V load dump transients. Familiar regulator features such as short circuit and thermal shutdown protection are also built in.

## Applications

- Automotive
- Industrial Control
- Point-of-Load regulation

## Simplified Schematic

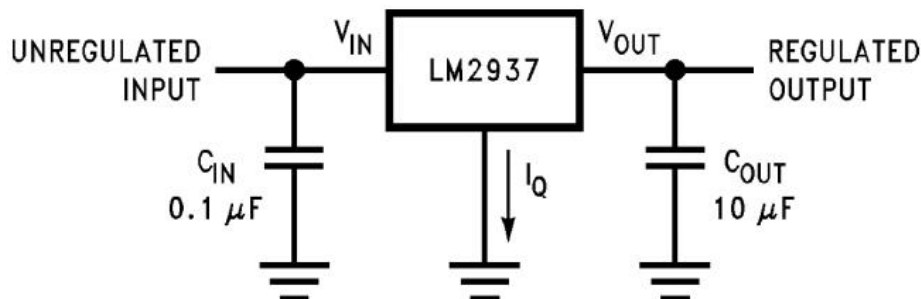

## Pin Configuration and Functions

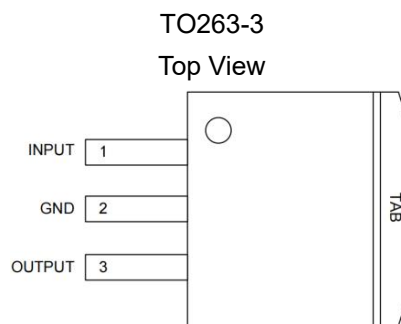
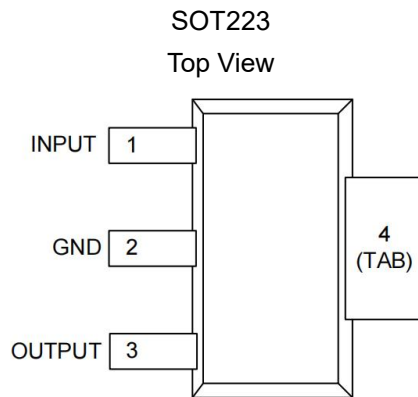
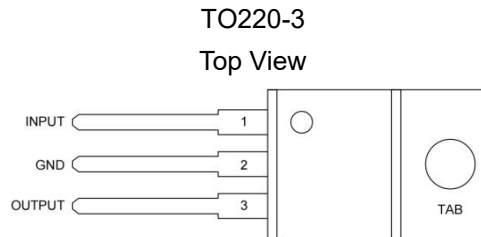

## Pin Functions

NAME	PIN			I/O	DESCRIPTION
	TO263	TO220	SOT223		
INPUT	1	1	1	I	Unregulated voltage input
GND	2	2	2	—	Ground
OUTPUT	3	3	3	O	Regulated voltage output. This pin requires an output capacitor to maintain stability. See the <i>Detailed Design Procedure</i> section for output capacitor details.
GND	TAB	TAB	4	—	Thermal and ground connection. Connect the TAB to a large copper area to remove heat from the device. The TAB is internally connected to device pin 2 (GND). Connect the TAB to GND or leave floating. Do not connect the TAB to any potential other than GND at device pin 2.

## Absolute Maximum Ratings<sup>(1)</sup>

over operating free-air temperature range (unless otherwise noted)

		MIN	MAX	UNIT
Input voltage ( $V_{IN}$ )	Continuous	26		V
	Transient ( $t \leq 100$ ms)	60		
Internal power dissipation <sup>(2)</sup>		Internally limited		
Maximum junction temperature		150		°C

- Stresses beyond those listed under Absolute Maximum Ratings may cause permanent damage to the device. These are stress ratings only, which do not imply functional operation of the device at these or any other conditions beyond those indicated under Recommended Operating Conditions. Exposure to absolute-maximum-rated conditions for extended periods may affect device reliability.
- The maximum allowable power dissipation at any ambient temperature is  $P_{MAX} = (125^{\circ}\text{C} - T_A)/R_{\theta JA}$ , where 125 is the maximum junction temperature for operation,  $T_A$  is the ambient temperature, and  $R_{\theta JA}$  is the junction-to-ambient thermal resistance. If this dissipation is exceeded, the die temperature will rise above 125°C and the electrical specifications do not apply. If the die temperature rises above 150°C, the LM2937 will go into thermal shutdown

## Handling Ratings

		MIN	MAX	UNIT
$T_{stg}$	Storage temperature range	-65	150	°C
$V_{(ESD)}$	Electrostatic discharge	Human body model (HBM), per ANSI/ESDA/JEDEC JS-001, allpins <sup>(1)</sup>		V

(1) JEDEC document JEP155 states that 500-V HBM allows safe manufacturing with a standard ESD control process.

## Recommended Operating Conditions<sup>(1)</sup>

over operating free-air temperature range (unless otherwise noted)

	MIN	NOM	MAX	UNIT
Junction temperature ( $T_J$ ) <sup>(2)</sup>	-40		85	°C
Input voltage ( $V_{IN}$ )	$V_{OUT} + 1V$		26	V

- Stresses beyond those listed under Absolute Maximum Ratings may cause permanent damage to the device. These are stress ratings only, which do not imply functional operation of the device at these or any other conditions beyond those indicated under Recommended Operating Conditions. Exposure to absolute-maximum-rated conditions for extended periods may affect device reliability.
- The maximum allowable power dissipation at any ambient temperature is  $P_{MAX} = (125^{\circ}\text{C} - T_A)/R_{\theta JA}$ , where 125°C is the maximum junction temperature for operation,  $T_A$  is the ambient temperature, and  $R_{\theta JA}$  is the junction-to-ambient thermal resistance. If this dissipation is exceeded, the die temperature will rise above 125°C and the electrical specifications do not apply. If the die temperature rises above 150°C, the LM2937 will go into thermal shutdown.

## Electrical Characteristics: LM2937-5.0

Unless otherwise specified:  $V_{IN} = V_{OUT(NOM)} + 5\text{ V}$ ;  $I_{OUT(MAX)} = 500\text{ mA}$  for the TO-220 and DDPAK/TO-263 packages;  $I_{OUT(MAX)} = 400\text{ mA}$  for the SOT-223 package; and  $C_{OUT} = 10\text{ }\mu\text{F}$ . Conditions and the associated minimum and maximum limits apply over the Recommended Operating temperature range for the specific package, unless otherwise noted.

PARAMETER	CONDITIONS	MIN	TYP	MAX	UNIT
Output voltage	$T_A = T_J = 25^\circ\text{C}$ , $5\text{ mA} \leq I_{OUT} \leq I_{OUT(MAX)}$	4.85	5	5.15	V
	$5\text{ mA} \leq I_{OUT} \leq I_{OUT(MAX)}$	4.75	5	5.25	V
Line regulation	$(V_{OUT} + 2\text{ V}) \leq V_{IN} \leq 26\text{ V}$ , $I_{OUT} = 5\text{ mA}$		15	50	mV
Load regulation	$5\text{ mA} \leq I_{OUT} \leq I_{OUT(MAX)}$		5	50	mV
Quiescent Current	$(V_{OUT} + 2\text{ V}) \leq V_{IN} \leq 26\text{ V}$ , $I_{OUT} = 5\text{ mA}$		2	10	mA
	$V_{IN} = (V_{OUT} + 5\text{ V})$ , $I_{OUT} = I_{OUT(MAX)}$		10	20	mA
Output noise voltage	10 Hz to 100 kHz, $I_{OUT} = 5\text{ mA}$		150		$\mu\text{Vrms}$
Long-term stability	1000 Hrs.		20		mV
Dropout voltage	$I_{OUT} = I_{OUT(MAX)}$	0.5			V
	$I_{OUT} = 50\text{ mA}$		110	250	mV
Short-circuit current		0.6		1	A
Peak line transient voltage	$t_f < 100\text{ ms}$ , $R_L = 100\text{ }\Omega$	60	75		V
Maximum operational input voltage			26		V
Reverse DC input voltage	$V_{OUT} \geq -0.6\text{ V}$ , $R_L = 100\text{ }\Omega$	-15	-30		V
Reverse transient input voltage	$t_r < 1\text{ ms}$ , $R_L = 100\text{ }\Omega$	-50	-75		V

## Electrical Characteristics: LM2937-8.0

Unless otherwise specified:  $V_{IN} = V_{OUT(NOM)} + 5\text{ V}$ ;  $I_{OUT(MAX)} = 500\text{ mA}$  for the TO-220 and DDPAK/TO-263 packages;  $I_{OUT(MAX)} = 400\text{ mA}$  for the SOT-223 package; and  $C = 10\text{ }\mu\text{F}$ . Conditions and the associated Minimum and Maximum limits apply over the Recommended Operating temperature range for the specific package, unless otherwise noted.

PARAMETER	CONDITIONS	MIN	TYP	MAX	UNIT
Output voltage	$T_A = T_J = 25^\circ\text{C}$ , $5\text{ mA} \leq I_{OUT} \leq I_{OUT(MAX)}$	7.76	8	8.24	V
	$5\text{ mA} \leq I_{OUT} \leq I_{OUT(MAX)}$	7.6	8	8.4	V
Line regulation	$(V_{OUT} + 2\text{ V}) \leq V_{IN} \leq 26\text{ V}$ , $I_{OUT} = 5\text{ mA}$		24	80	mV
Load regulation	$5\text{ mA} \leq I_{OUT} \leq I_{OUT(MAX)}$		8	80	mV
Quiescent Current	$(V_{OUT} + 2\text{ V}) \leq V_{IN} \leq 26\text{ V}$ , $I_{OUT} = 5\text{ mA}$		2	10	mA
	$V_{IN} = (V_{OUT} + 5\text{ V})$ , $I_{OUT} = I_{OUT(MAX)}$		10	20	mA
Output noise voltage	10 Hz to 100 kHz, $I_{OUT} = 5\text{ mA}$		240		$\mu\text{Vrms}$
Long-term stability	1000 Hrs.		32		mV
Dropout voltage	$I_{OUT} = I_{OUT(MAX)}$	0.5			V
	$I_{OUT} = 50\text{ mA}$		110	250	mV
Short-circuit current		0.6		1	A
Peak line transient voltage	$t_f < 100\text{ ms}$ , $R_L = 100\text{ }\Omega$	60	75		V
Maximum operational input voltage			26		V
Reverse DC input voltage	$V_{OUT} \geq -0.6\text{ V}$ , $R_L = 100\text{ }\Omega$	-15	-30		V
Reverse transient input voltage	$t_r < 1\text{ ms}$ , $R_L = 100\text{ }\Omega$	-50	-75		V

## Electrical Characteristics: LM2937-10

Unless otherwise specified:  $V_{IN} = V_{OUT(NOM)} + 5\text{ V}$ ;  $I_{OUT(MAX)} = 500\text{ mA}$  for the TO-220 and DDPAK/TO-263 packages;  $I_{OUT(MAX)} = 400\text{ mA}$  for the SOT-223 package; and  $C_{OUT} = 10\text{ }\mu\text{F}$ . Conditions and the associated Minimum and Maximum limits apply over the Recommended Operating temperature range for the specific package, unless otherwise noted.

PARAMETER	CONDITIONS	MIN	TYP	MAX	UNIT
Output voltage	$T_A = T_J = 25^\circ\text{C}$ , $5\text{ mA} \leq I_{OUT} \leq I_{OUT(MAX)}$	9.7	10	10.3	V
	$5\text{ mA} \leq I_{OUT} \leq I_{OUT(MAX)}$	9.5	10	10.5	V
Line regulation	$(V_{OUT} + 2\text{V}) \leq V_{IN} \leq 26\text{V}$ , $I_{OUT} = 5\text{ mA}$		30	100	mV
Load regulation	$5\text{ mA} \leq I_{OUT} \leq I_{OUT(MAX)}$		10	100	mV
Quiescent Current	$(V_{OUT} + 2\text{V}) \leq V_{IN} \leq 26\text{V}$ , $I_{OUT} = 5\text{ mA}$		2	10	mA
	$V_{IN} = (V_{OUT} + 5\text{V})$ , $I_{OUT} = I_{OUT(MAX)}$		10	20	mA
Output noise voltage	10 Hz to 100 kHz, $I_{OUT} = 5\text{ mA}$		300		$\mu\text{Vrms}$
Long-term stability	1000 Hrs.		40		mV
Dropout voltage	$I_{OUT} = I_{OUT(MAX)}$	0.5			V
	$I_{OUT} = 50\text{ mA}$		110	250	mV
Short-circuit current		0.6		1	A
Peak line transient voltage	$t_f < 100\text{ ms}$ , $R_L = 100\text{ }\Omega$	60	75		V
Maximum operational input voltage			26		V
Reverse DC input voltage	$V_{OUT} \geq -0.6\text{ V}$ , $R_L = 100\text{ }\Omega$	-15	-30		V
Reverse transient input voltage	$t_r < 1\text{ ms}$ , $R_L = 100\text{ }\Omega$	-50	-75		V

## Electrical Characteristics: LM2937-12

Unless otherwise specified:  $V_{IN} = V_{OUT(NOM)} + 5\text{ V}$ ;  $I_{OUT(MAX)} = 500\text{ mA}$  for the TO-220 and DDPAK/TO-263 packages;  $I_{OUT(MAX)} = 400\text{ mA}$  for the SOT-223 package; and  $C_{OUT} = 10\text{ }\mu\text{F}$ . Conditions and the associated Minimum and Maximum limits apply over the Recommended Operating temperature range for the specific package, unless otherwise noted.

PARAMETER	CONDITIONS	MIN	TYP	MAX	UNIT
Output voltage	$T_A = T_J = 25^\circ\text{C}$ , $5\text{ mA} \leq I_{OUT} \leq I_{OUT(MAX)}$	11.64	12	12.36	V
	$5\text{ mA} \leq I_{OUT} \leq I_{OUT(MAX)}$	11.4	12	12.6	V
Line regulation	$(V_{OUT} + 2\text{V}) \leq V_{IN} \leq 26\text{V}$ , $I_{OUT} = 5\text{ mA}$		36	120	mV
Load regulation	$5\text{ mA} \leq I_{OUT} \leq I_{OUT(MAX)}$		12	120	mV
Quiescent Current	$(V_{OUT} + 2\text{V}) \leq V_{IN} \leq 26\text{V}$ , $I_{OUT} = 5\text{ mA}$		2	10	mA
	$V_{IN} = (V_{OUT} + 5\text{V})$ , $I_{OUT} = I_{OUT(MAX)}$		10	20	mA
Output noise voltage	10 Hz to 100 kHz, $I_{OUT} = 5\text{ mA}$		360		$\mu\text{Vrms}$
Long-term stability	1000 Hrs.		44		mV
Dropout voltage	$I_{OUT} = I_{OUT(MAX)}$		0.5 1		V
	$I_{OUT} = 50\text{ mA}$		110	250	mV
Short-circuit current		0.6		1	A
Peak line transient voltage	$t_f < 100\text{ ms}$ , $R_L = 100\text{ }\Omega$	60	75		V
Maximum operational input voltage			26		V
Reverse DC input voltage	$V_{OUT} \geq -0.6\text{ V}$ , $R_L = 100\text{ }\Omega$	-15	-30		V
Reverse transient input voltage	$t_r < 1\text{ ms}$ , $R_L = 100\text{ }\Omega$	-50	-75		V

**Electrical Characteristics: LM2937-15**

Unless otherwise specified:  $V_{IN} = V_{OUT(NOM)} + 5\text{ V}$ ;  $I_{OUT(MAX)} = 500\text{ mA}$  for the TO-220 and DDPAK/TO-263 packages;  $I_{OUT(MAX)} = 400\text{ mA}$  for the SOT-223 package; and  $C_{OUT} = 10\text{ }\mu\text{F}$ . Conditions and the associated Minimum and Maximum limits apply over the Recommended Operating temperature range for the specific package, unless otherwise noted.

PARAMETER	CONDITIONS	MIN	TYP	MAX	UNIT
Output voltage	$T_A = T_J = 25^\circ\text{C}$ , $5\text{ mA} \leq I_{OUT} \leq I_{OUT(MAX)}$	14.55	15	15.45	V
	$5\text{ mA} \leq I_{OUT} \leq I_{OUT(MAX)}$	14.25	15	15.75	V
Line regulation	$(V_{OUT} + 2\text{V}) \leq V_{IN} \leq 26\text{V}$ , $I_{OUT} = 5\text{ mA}$		45	150	mV
Load regulation	$5\text{ mA} \leq I_{OUT} \leq I_{OUT(MAX)}$		15	150	mV
Quiescent Current	$(V_{OUT} + 2\text{V}) \leq V_{IN} \leq 26\text{V}$ , $I_{OUT} = 5\text{ mA}$		2	10	mA
	$V_{IN} = (V_{OUT} + 5\text{V})$ , $I_{OUT} = I_{OUT(MAX)}$		10	20	mA
Output noise voltage	10 Hz to 100 kHz, $I_{OUT} = 5\text{ mA}$		450		$\mu\text{Vrms}$
Long-term stability	1000 Hrs.		56		mV
Dropout voltage	$I_{OUT} = I_{OUT(MAX)}$	0.5			V
	$I_{OUT} = 50\text{ mA}$		110	250	mV
Short-circuit current		0.6		1	A
Peak line transient voltage	$t_f < 100\text{ ms}$ , $R_L = 100\text{ }\Omega$	60	75		V
Maximum operational input voltage			26		V
Reverse DC input voltage	$V_{OUT} \geq -0.6\text{ V}$ , $R_L = 100\text{ }\Omega$	-15	-30		V
Reverse transient input voltage	$t_r < 1\text{ ms}$ , $R_L = 100\text{ }\Omega$	-50	-75		V

**Typical Characteristics**

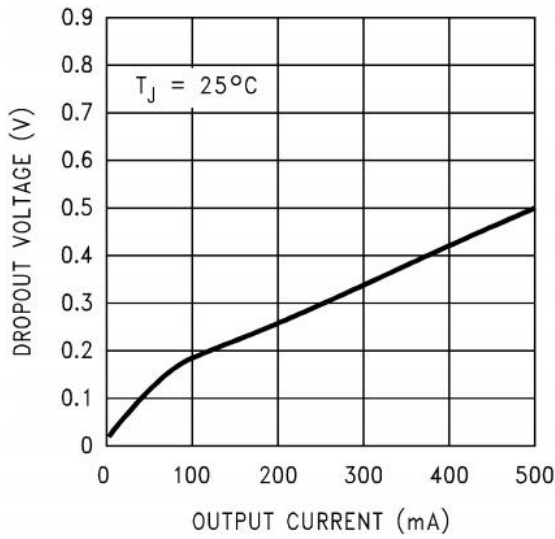

Figure 1. Dropout Voltage vs. Output Current

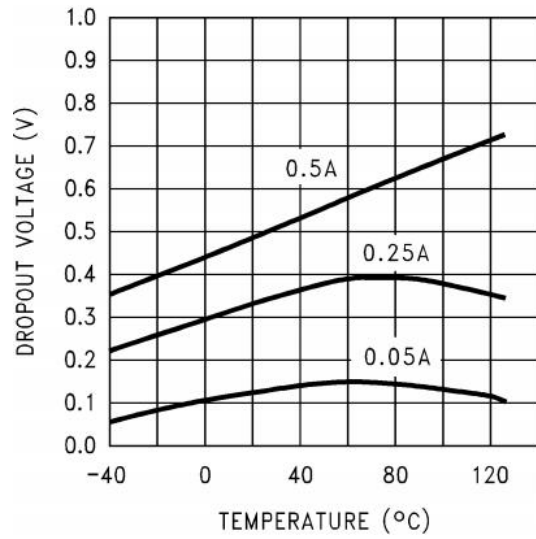

Figure 2. Dropout Voltage vs. Temperature

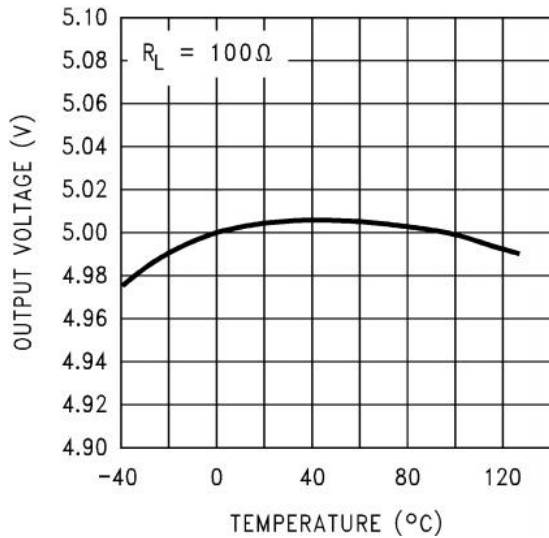

Figure 3. Output Voltage vs. Temperature

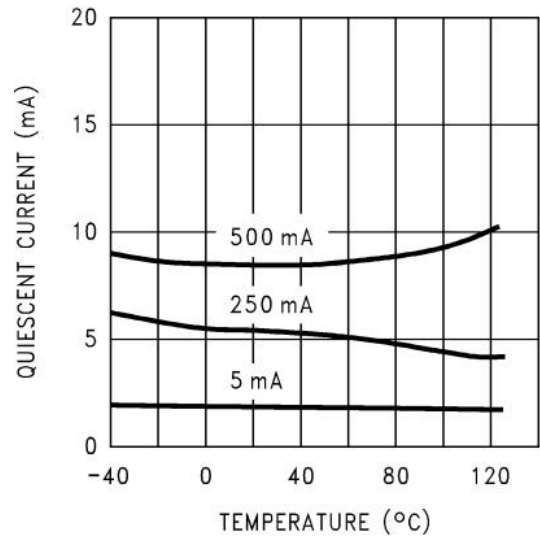

Figure 4. Quiescent Current vs. Temperature

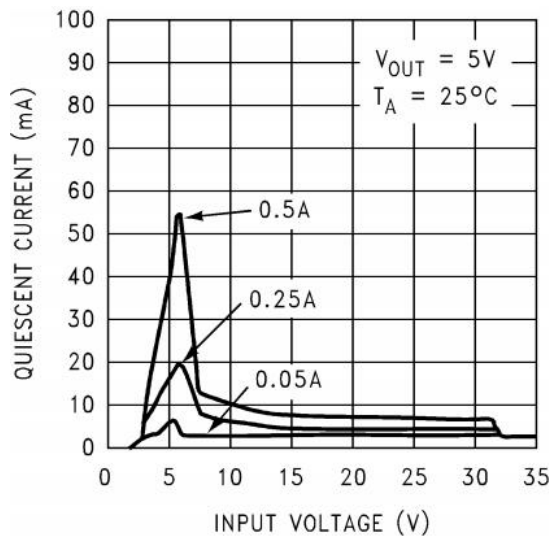

Figure 5. Quiescent Current vs. Input Voltage

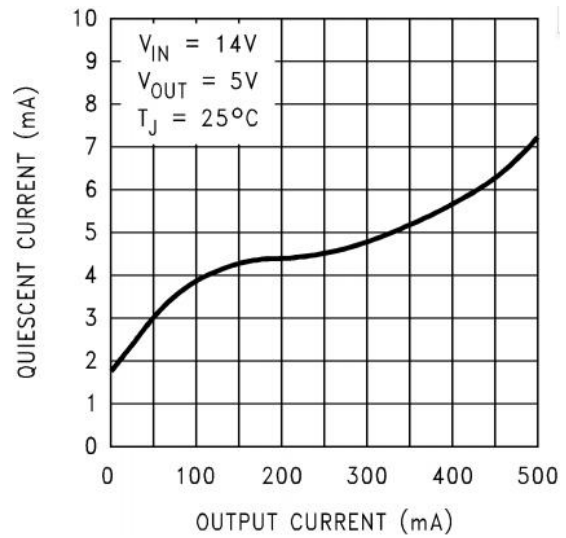

Figure 6. Quiescent Current vs. Output Current



Typical Characteristics (continued)

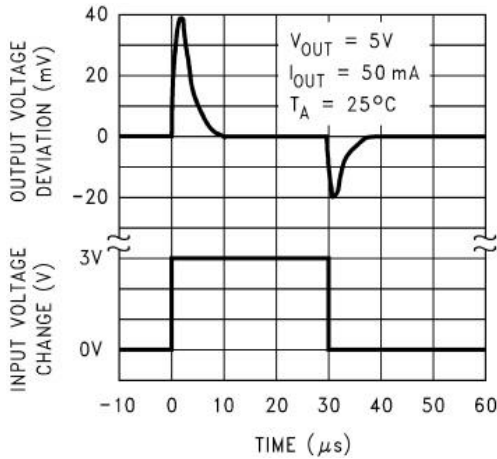

Figure 7. Line Transient Response

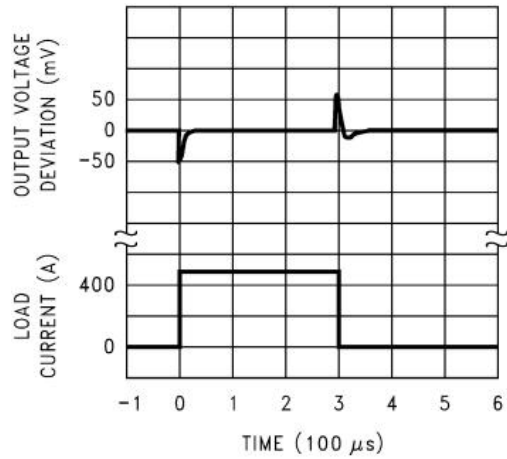

Figure 8. Load Transient Response

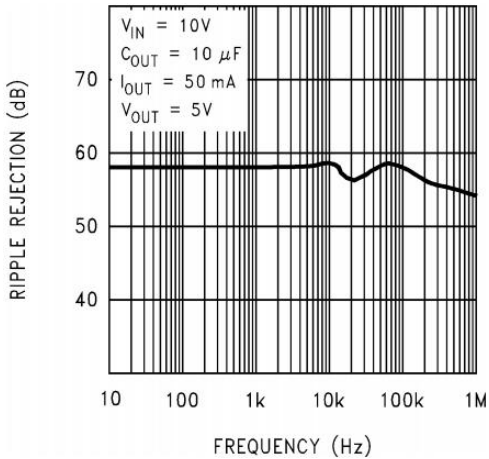

Figure 9. Ripple Rejection

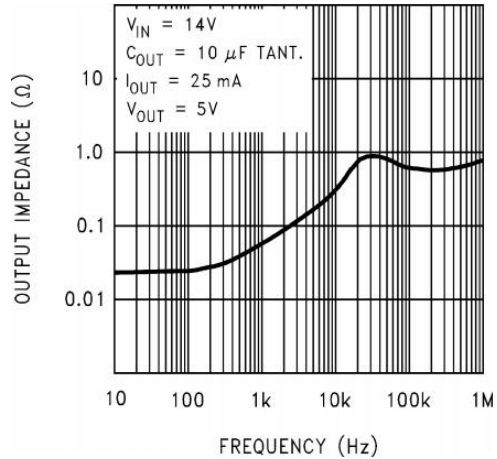

Figure 10. Output Impedance

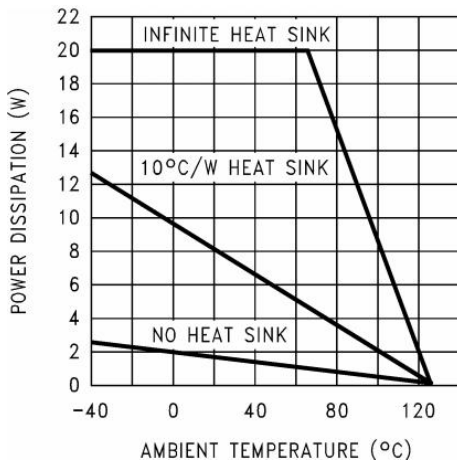

Figure 11. Maximum Power Dissipation (TO-220)<sup>1</sup>

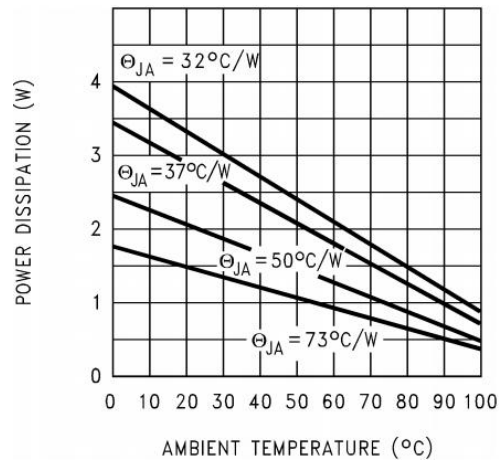

Figure 12. Maximum Power Dissipation (TO-263)

1. The maximum allowable power dissipation at any ambient temperature is  $P_{MAX} = (125^{\circ}C - T_A)/R_{\theta JA}$ , where 125 is the maximum junction temperature for operation,  $T_A$  is the ambient temperature, and  $R_{\theta JA}$  is the junction-to-ambient thermal resistance. If this dissipation is exceeded, the die temperature will rise above  $125^{\circ}C$  and the electrical specifications do not apply. If the die temperature rises above  $150^{\circ}C$ , the LM2937 will go into thermal shutdown.

Typical Characteristics (continued)

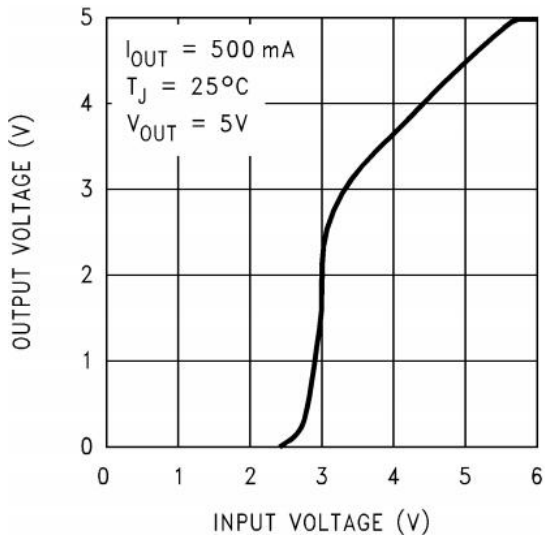

Figure 13. Low-Voltage Behavior

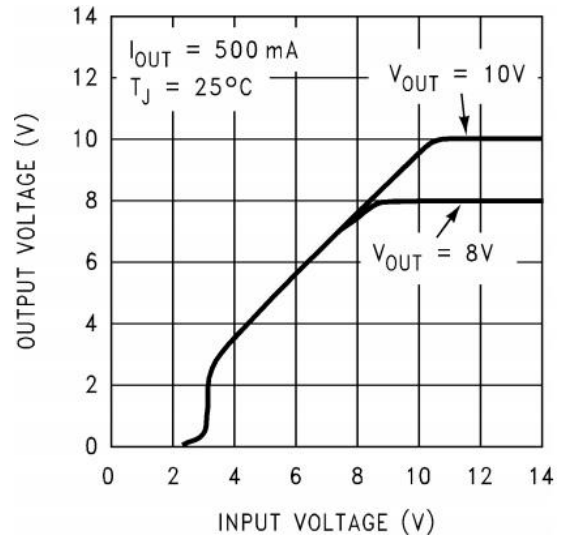

Figure 14. Low-Voltage Behavior

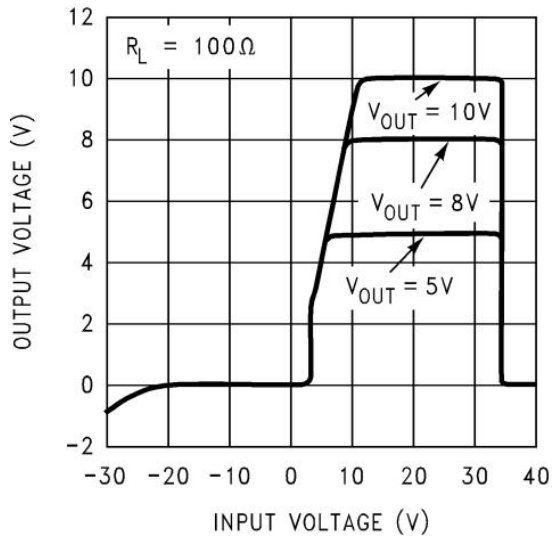

Figure 15. Output at Voltage Extremes

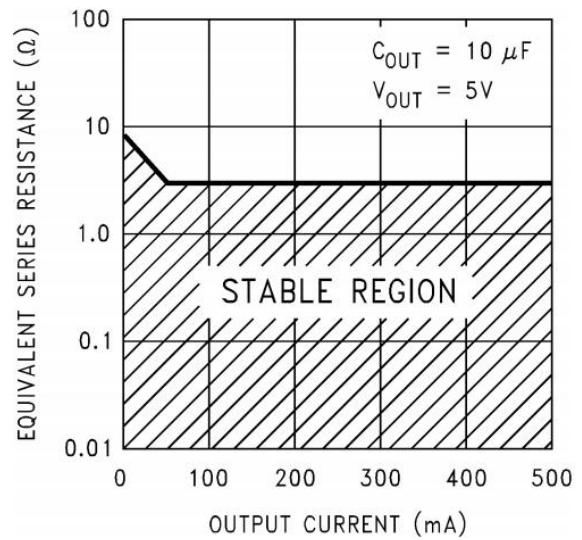

Figure 16. Output Capacitor ESR

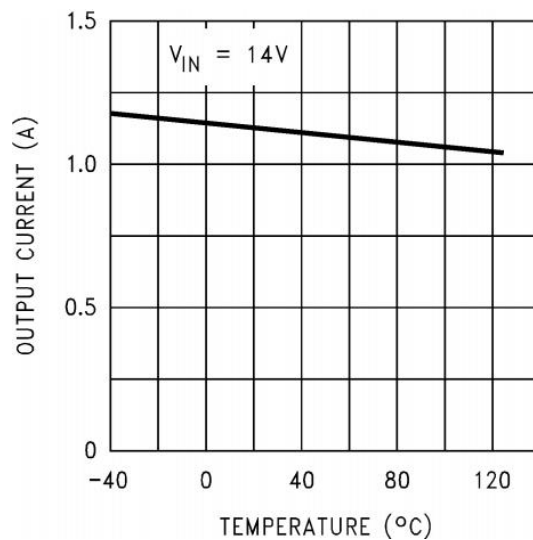
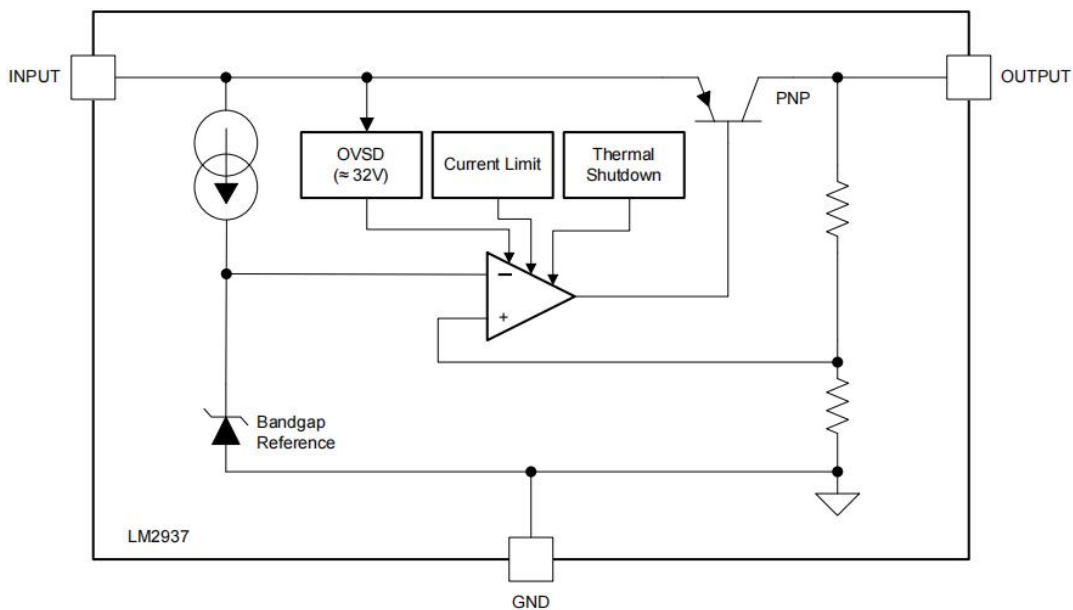

Figure 17. Peak Output Current

## Overview

The LM2937 is a positive voltage regulator capable of supplying up to 500 mA of load current. The use of a PNP power transistor provides a low dropout voltage characteristic. With a load current of 500 mA the minimum input to output voltage differential required for the output to remain in regulation is typically 0.5 V (1 V ensured maximum over the full operating temperature range). Special circuitry has been incorporated to minimize the quiescent current to typically only 10 mA with a full 500-mA load current when the input to output voltage differential is greater than 3 V.

## Functional Block Diagram



## Thermal Shutdown (TSD)

The Thermal Shutdown circuitry of the LM2937 has been designed to protect the device against temporary thermal overload conditions. The TSD circuitry is not intended to replace proper heat-sinking. Continuously running the LM2937 device at thermal shutdown may degrade device reliability as the junction temperature will be exceeding the absolute maximum junction temperature rating.

## Short Circuit Current Limit

The output current limiting circuitry of the LM2937 has been designed to limit the output current in cases where the load impedance is unusually low. This includes situations where the output may be shorted directly to ground. Continuous operation of the LM2937 at the current limit will typically result in the LM2937 transitioning into Thermal Shutdown mode.

## Overvoltage Shutdown (OVSD)

Input voltages greater than typically 32 V will cause the LM2937 output to be disabled. When operating with the input voltage greater than the maximum recommended input voltage of 26 V the device performance is not ensured. Continuous operation with the input voltage greater than the maximum recommended input voltage is discouraged.

## Device Functional Modes

The LM2937 design does not include any undervoltage lock-out (UVLO), or enable functions. Generally, the output voltage will track the input voltage until the input voltage is greater than  $V_{OUT} + 1V$ . When the input voltage is greater than  $V_{OUT} + 1V$  the LM2937 will be in linear operation, and the output voltage will be regulated; however, the device will be sensitive to any small perturbation of the input voltage. Device dynamic performance is improved when the input voltage is at least 2 V greater than the output voltage.

## Typical Application

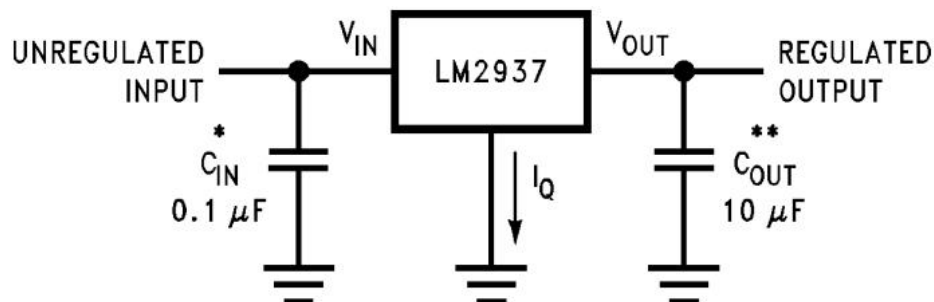

\*Required if the regulator is located more than 3 inches from the power-supply-filter capacitors.

\*\*Required for stability.  $C_{OUT}$  must be at least 10  $\mu F$  (over full expected operating temperature range) and located as close as possible to the regulator. The equivalent series resistance, ESR, of this capacitor may be as high as 3  $\Omega$ .

## Physical Dimensions

### TO263-3

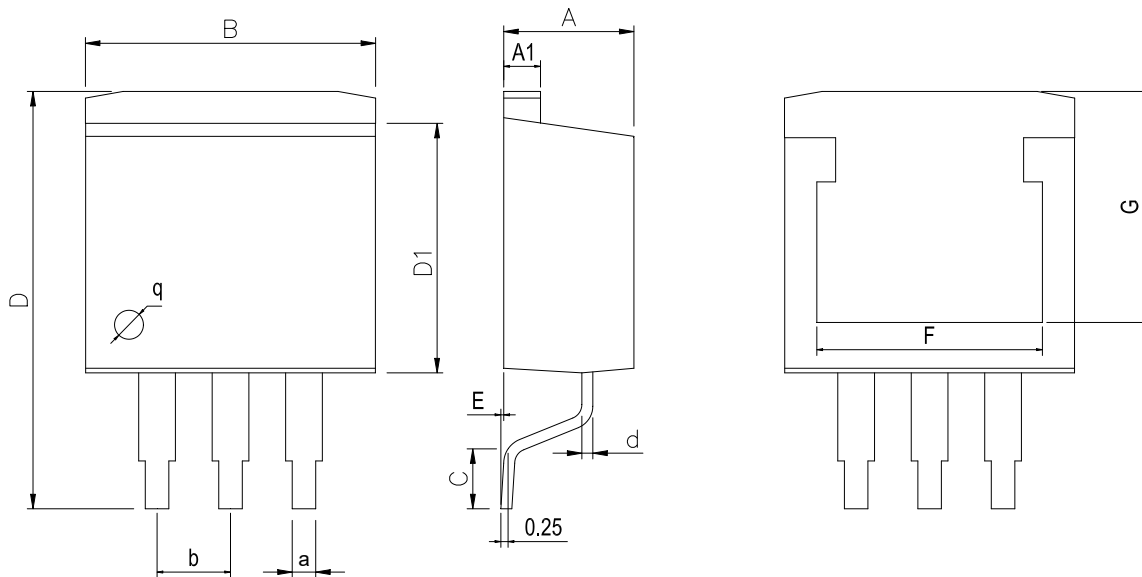

**Dimensions In Millimeters(TO263-3)**

Symbol:	A	A1	B	C	D	D1	E	F	G	a	b
Min:	4.45	1.22	10	1.89	13.7	8.38	0	8.332	7.70	0.71	2.54BSC
Max:	4.62	1.32	10.4	2.19	14.6	8.89	0.305	8.552	8.10	0.97	

### TO220-3

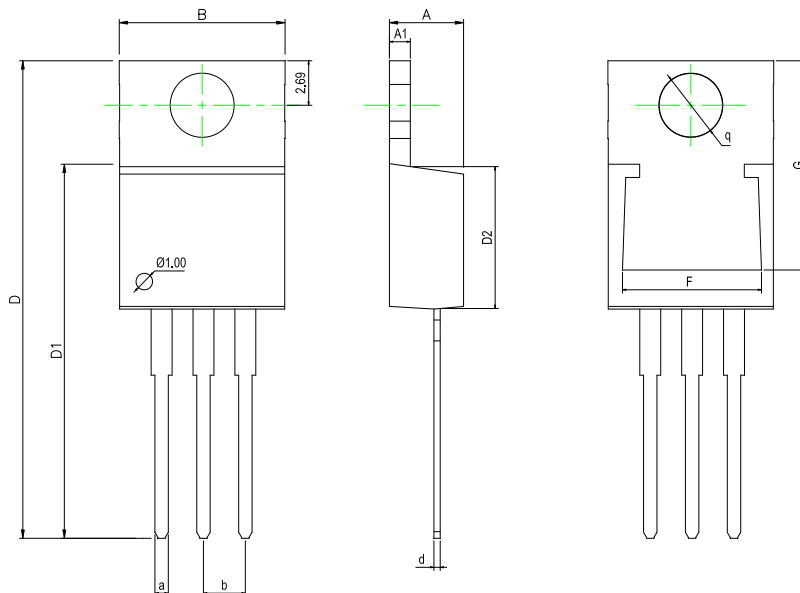

**Dimensions In Millimeters(TO220-3)**

Symbol:	A	A1	B	D	D1	D2	F	G	a	d	b	q
Min:	4.45	1.22	10	28.2	22.22	8.50	8.30	12.55	0.71	0.33	2.54BS	3.80TYP
Max:	4.62	1.32	10.4	28.9	22.62	9.10	8.55	12.75	0.97	0.42	C	

**Physical Dimensions**

SOT223

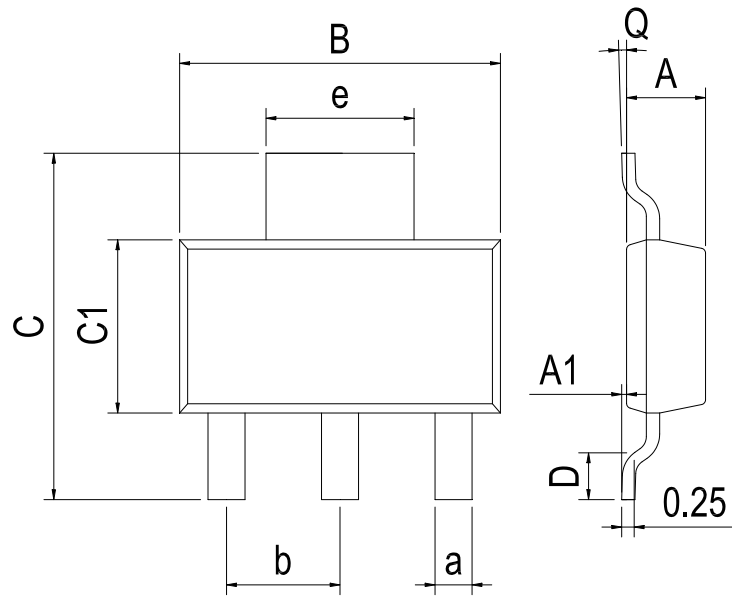

Dimensions In Millimeters(SOT223)										
Symbol:	A	A1	B	C	C1	D	Q	a	b	e
Min:	1.50	0.05	6.30	6.70	3.30	0.65	0°	0.66	2.30 BSC	3.00 BSC
Max:	1.70	0.20	6.70	7.30	3.70	1.10	8°	0.84		

**IMPORTANT STATEMENT:**

Huaguan Semiconductor reserves the right to change its products and services without notice. Before ordering, the customer shall obtain the latest relevant information and verify whether the information is up to date and complete. Huaguan Semiconductor does not assume any responsibility or obligation for the altered documents.

Customers are responsible for complying with safety standards and taking safety measures when using Huaguan Semiconductor products for system design and machine manufacturing. You will bear all the following responsibilities: select the appropriate Huaguan Semiconductor products for your application; Design, validate and test your application; Ensure that your application meets the appropriate standards and any other safety, security or other requirements. To avoid the occurrence of potential risks that may lead to personal injury or property loss.

Huaguan Semiconductor products have not been approved for applications in life support, military, aerospace and other fields, and Huaguan Semiconductor will not bear the consequences caused by the application of products in these fields.

The technical and reliability data (including data sheets), design resources (including reference designs), application or other design suggestions, network tools, safety information and other resources provided for the performance of semiconductor products produced by Huaguan Semiconductor are not guaranteed to be free from defects and no warranty, express or implied, is made. The use of testing and other quality control technologies is limited to the quality assurance scope of Huaguan Semiconductor. Not all parameters of each device need to be tested.

The documentation of Huaguan Semiconductor authorizes you to use these resources only for developing the application of the product described in this document. You have no right to use any other Huaguan Semiconductor intellectual property rights or any third party intellectual property rights. It is strictly forbidden to make other copies or displays of these resources. You should fully compensate Huaguan Semiconductor and its agents for any claims, damages, costs, losses and debts caused by the use of these resources. Huaguan Semiconductor accepts no liability for any loss or damage caused by infringement.

## X-ON Electronics

Largest Supplier of Electrical and Electronic Components

*Click to view similar products for [Linear Voltage Regulators](#) category:*

*Click to view products by [HGSEMI](#) manufacturer:*

Other Similar products are found below :

[LV56831P-E](#) [LV5684PVD-XH](#) [MCDTSA6-2R](#) [L7815ACV-DG](#) [PQ3DZ53U](#) [LV56801P-E](#) [TLE42794G](#) [L78L05CZ/1SX](#) [L78LR05DL-MA-E](#) [636416C](#) [714954EB](#) [BA033LBSG2-TR](#) [LV5680P-E](#) [L78M15CV-DG](#) [TLS202B1MBV33HTSA1](#) [L79M05T-E](#) [TLS202A1MBVHTSA1](#) [L78LR05D-MA-E](#) [NCV317MBTG](#) [NTE7227](#) [LV5680NPVC-XH](#) [LT1054CN8](#) [MP2018GZD-5-Z](#) [MP2018GZD-33-Z](#) [MIC5281-3.3YMM](#) [MC78L06BP-AP](#) [TA48LS05F\(TE85L,F\)](#) [TA78L12F\(TE12L,F\)](#) [TC47BR5003ECT](#) [TCR2LN12,LF\(S](#) [TCR2LN28,LF\(S](#) [TCR2LN30,LF\(S](#) [TCR3DF295,LM\(CT](#) [TCR3DF40,LM\(CT](#) [BA178M20CP-E2](#) [L78M12ABDT](#) [LM7812SX/NOPB](#) [LR645N3-G-P003](#) [LR645N3-G-P013](#) [ZXTR2005P5-13](#) [SCD7812BTG](#) [TCR3DF335,LM\(CT](#) [ZXTR2012K-13](#) [TLE42994E V33](#) [ZXTR2008K-13](#) [ZXTR2005K-13](#) [L88R05DL-E](#) [ADP3300ARTZ-2.7RL7](#) [LM120K-15/883](#) [IFX54441LDVXUMA1](#)