

QUAD DIFFERENTIAL COMPARATORS

FEATURES

- **Wide Supply Ranges**
 - **Single Supply: 2 V to 36 V**
(Tested to 30 V for Non-V Devices and 32 V for V-Suffix Devices)
 - **Dual Supplies: ± 1 V to ± 18 V**
(Tested to ± 15 V for Non-V Devices and ± 16 V for V-Suffix Devices)
- **Low Supply-Current Drain Independent of Supply Voltage: 0.8 mA (Typ)**
- **Low Input Bias Current: 25 nA (Typ)**
- **Low Input Offset Current: 3 nA (Typ) (LM139)**
- **Low Input Offset Voltage: 2 mV (Typ)**
- **Common-Mode Input Voltage Range Includes Ground**
- **Differential Input Voltage Range Equal to Maximum-Rated Supply Voltage: ± 36 V**
- **Low Output Saturation Voltage**
- **Output Compatible With TTL, MOS, and CMOS**

LM139, LM139A . . . D, J, OR W PACKAGE

LM239 . . . D, N, OR PW PACKAGE

LM239A . . . D PACKAGE

LM339, LM339A . . . D, DB, N, NS, OR PW PACKAGE

LM2901 . . . D, N, NS, OR PW PACKAGE

(TOP VIEW)

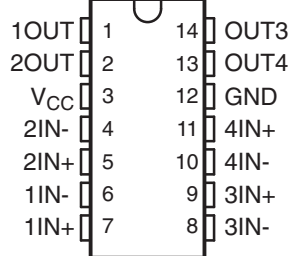

SYMBOL (EACH COMPARATOR)

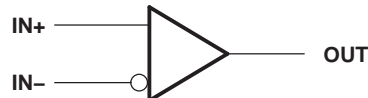

SCHEMATIC (EACH COMPARATOR)

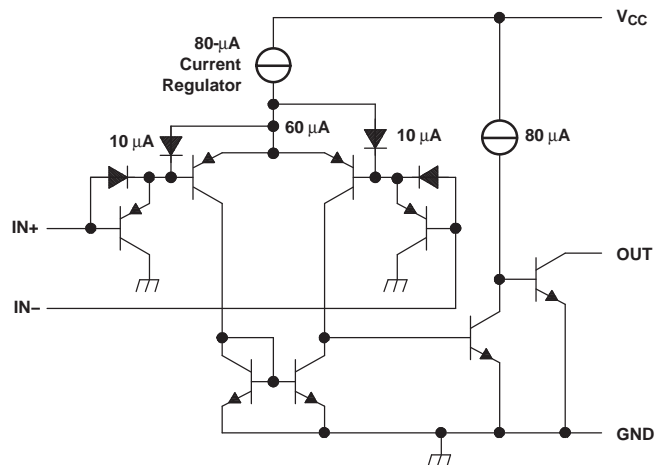

All current values shown are nominal.

ELECTRICAL CHARACTERISTICS

 at specified free-air temperature, $V_{CC} = 5\text{ V}$ (unless otherwise noted)

PARAMETER	TEST CONDITIONS ⁽¹⁾	T_A ⁽²⁾	LM139			LM139A			UNIT
			MIN	TYP	MAX	MIN	TYP	MAX	
V_{IO} Input offset voltage	$V_{CC} = 5\text{ V to } 30\text{ V}$, $V_{IC} = V_{ICR\text{ min}}$, $V_O = 1.4\text{ V}$	25°C		2	5		1	2	mV
		Full range			9			4	
I_{IO} Input offset current	$V_O = 1.4\text{ V}$	25°C		3	25		3	25	nA
		Full range			100			100	
I_{IB} Input bias current	$V_O = 1.4\text{ V}$	25°C		-25	-100		-25	-100	nA
		Full range			-300			-300	
V_{ICR} Common-mode input-voltage range ⁽³⁾		25°C		0 to $V_{CC} - 1.5$		0 to $V_{CC} - 1.5$			V
		Full range		0 to $V_{CC} - 2$		0 to $V_{CC} - 2$			
A_{VD} Large-signal differential-voltage amplification	$V_{CC+} = \pm 7.5\text{ V}$, $V_O = -5\text{ V to } 5\text{ V}$	25°C		200		50	200	V/mV	
I_{OH} High-level output current	$V_{ID} = 1\text{ V}$	$V_{OH} = 5\text{ V}$	25°C		0.1		0.1	nA	
		$V_{OH} = 30\text{ V}$	Full range			1		1	μA
V_{OL} Low-level output voltage	$V_{ID} = -1\text{ V}$, $I_{OL} = 4\text{ mA}$	25°C		150	400		150	400	mV
		Full range			700			700	
I_{OL} Low-level output current	$V_{ID} = -1\text{ V}$, $V_{OL} = 1.5\text{ V}$	25°C		6	16		6	16	mA
I_{CC} Supply current (four comparators)	$V_O = 2.5\text{ V}$, No load	25°C		0.8	2		0.8	2	mA

- (1) All characteristics are measured with zero common-mode input voltage, unless otherwise specified.
 (2) Full range (MIN to MAX) for LM139 and LM139A is -55°C to 125°C . All characteristics are measured with zero common-mode input voltage, unless otherwise specified.
 (3) The voltage at either input or common-mode should not be allowed to go negative by more than 0.3 V. The upper end of the common-mode voltage range is $V_{CC+} - 1.5\text{ V}$; however, one input can exceed V_{CC} , and the comparator will provide a proper output state as long as the other input remains in the common-mode range. Either or both inputs can go to 30 V without damage.

SWITCHING CHARACTERISTICS

 $V_{CC} = 5\text{ V}$, $T_A = 25^\circ\text{C}$

PARAMETER	TEST CONDITIONS	LM139 LM139A	UNIT	
		TYP		
Response time	R_L connected to 5 V through 5.1 k Ω , $C_L = 15\text{ pF}$ ^{(1) (2)}	100-mV input step with 5-mV overdrive	1.3	μs
		TTL-level input step	0.3	

- (1) C_L includes probe and jig capacitance.
 (2) The response time specified is the interval between the input step function and the instant when the output crosses 1.4 V.

ELECTRICAL CHARACTERISTICS

 at specified free-air temperature, $V_{CC} = 5\text{ V}$ (unless otherwise noted)

PARAMETER	TEST CONDITIONS ⁽¹⁾	T_A ⁽²⁾	LM239 LM339			LM239A LM339A			UNIT		
			MIN	TYP	MAX	MIN	TYP	MAX			
V_{IO} Input offset voltage	$V_{CC} = 5\text{ V to } 30\text{ V}$, $V_{IC} = V_{ICR\text{ min}}$, $V_O = 1.4\text{ V}$	25°C	2		5	1		3	mV		
		Full range	9			4					
I_{IO} Input offset current	$V_O = 1.4\text{ V}$	25°C	5		50	5		50	nA		
		Full range	150			150					
I_{IB} Input bias current	$V_O = 1.4\text{ V}$	25°C	-25		-250	-25		-250	nA		
		Full range	-400			-400					
V_{ICR} Common-mode input-voltage range ⁽³⁾		25°C	0 to $V_{CC} - 1.5$			0 to $V_{CC} - 1.5$			V		
		Full range	0 to $V_{CC} - 2$			0 to $V_{CC} - 2$					
A_{VD} Large-signal differential-voltage amplification	$V_{CC} = 15\text{ V}$, $V_O = 1.4\text{ V to } 11.4\text{ V}$, $R_L \geq 15\text{ k}\Omega\text{ to } V_{CC}$	25°C	50		200	50		200	V/mV		
I_{OH} High-level output current	$V_{ID} = 1\text{ V}$	$V_{OH} = 5\text{ V}$	25°C		0.1		50	0.1		50	nA
		$V_{OH} = 30\text{ V}$	Full range			1		1		μA	
V_{OL} Low-level output voltage	$V_{ID} = -1\text{ V}$, $I_{OL} = 4\text{ mA}$	25°C	150		400	150		400	mV		
		Full range	700			700					
I_{OL} Low-level output current	$V_{ID} = -1\text{ V}$, $V_{OL} = 1.5\text{ V}$	25°C	6		16	6		16	mA		
I_{CC} Supply current (four comparators)	$V_O = 2.5\text{ V}$, No load	25°C	0.8		2	0.8		2	mA		

- (1) All characteristics are measured with zero common-mode input voltage, unless otherwise specified.
 (2) Full range (MIN to MAX) for LM239/LM239A is -25°C to 85°C , and for LM339/LM339A is 0°C to 70°C . All characteristics are measured with zero common-mode input voltage, unless otherwise specified.
 (3) The voltage at either input or common-mode should not be allowed to go negative by more than 0.3 V. The upper end of the common-mode voltage range is $V_{CC+} - 1.5\text{ V}$; however, one input can exceed V_{CC-} and the comparator will provide a proper output state as long as the other input remains in the common-mode range. Either or both inputs can go to 30 V without damage.

SWITCHING CHARACTERISTICS
 $V_{CC} = 5\text{ V}$, $T_A = 25^\circ\text{C}$

PARAMETER	TEST CONDITIONS	LM239 LM239A LM339 LM339A	UNIT	
		TYP		
Response time	R_L connected to 5 V through 5.1 k Ω , $C_L = 15\text{ pF}$ ⁽¹⁾ ⁽²⁾	100-mV input step with 5-mV overdrive	1.3	μs
		TTL-level input step	0.3	

- (1) C_L includes probe and jig capacitance.
 (2) The response time specified is the interval between the input step function and the instant when the output crosses 1.4 V.

ELECTRICAL CHARACTERISTICS

 at specified free-air temperature, $V_{CC} = 5\text{ V}$ (unless otherwise noted)

PARAMETER	TEST CONDITIONS ⁽¹⁾		T_A ⁽²⁾	LM2901			UNIT
				MIN	TYP	MAX	
V_{IO} Input offset voltage	$V_{IC} = V_{ICR} \text{ min,}$ $V_O = 1.4\text{ V,}$ $V_{CC} = 5\text{ V to MAX}^{(3)}$	Non-A devices	25°C	2	7	mV	
			Full range		15		
		A-suffix devices	25°C		1		2
			Full range				4
I_{IO} Input offset current	$V_O = 1.4\text{ V}$		25°C	5	50	nA	
			Full range		200		
I_{IB} Input bias current	$V_O = 1.4\text{ V}$		25°C	-25	-250	nA	
			Full range		-500		
V_{ICR} Common-mode input-voltage range ⁽⁴⁾			25°C	0 to $V_{CC} - 1.5$		V	
			Full range	0 to $V_{CC} - 2$			
A_{VD} Large-signal differential-voltage amplification	$V_{CC} = 15\text{ V, } V_O = 1.4\text{ V to } 11.4\text{ V,}$ $R_L \geq 15\text{ k}\Omega \text{ to } V_{CC}$		25°C	25	100	V/mV	
I_{OH} High-level output current	$V_{ID} = 1\text{ V}$		25°C	0.1	50	nA	
			Full range		1	μA	
V_{OL} Low-level output voltage	$V_{ID} = -1\text{ V,}$ $I_{OL} = 4\text{ mA}$	Non-V devices	25°C	150	500	mV	
		V-suffix devices		150	400		
		All devices	Full range		700		
I_{OL} Low-level output current	$V_{ID} = -1\text{ V,}$	$V_{OL} = 1.5\text{ V}$	25°C	6	16	mA	
I_{CC} Supply current (four comparators)	$V_O = 2.5\text{ V,}$ No load		25°C	0.8	2	mA	
			Full range		1		2.5

- (1) All characteristics are measured with zero common-mode input voltage, unless otherwise specified.
 (2) Full range (MIN to MAX) for LM2901 is -40°C to 125°C . All characteristics are measured with zero common-mode input voltage, unless otherwise specified.
 (3) $V_{CC} \text{ MAX} = 30\text{ V}$ for non-V devices, and 32 V for V-suffix devices
 (4) The voltage at either input or common-mode should not be allowed to go negative by more than 0.3 V . The upper end of the common-mode voltage range is $V_{CC+} - 1.5\text{ V}$; however, one input can exceed V_{CC} , and the comparator will provide a proper output state as long as the other input remains in the common-mode range. Either or both inputs can go to $V_{CC} \text{ MAX}$ without damage.

SWITCHING CHARACTERISTICS

 $V_{CC} = 5\text{ V, } T_A = 25^\circ\text{C}$

PARAMETER	TEST CONDITIONS		LM2901	UNIT
			TYP	
Response time	R_L connected to 5 V through $5.1\text{ k}\Omega,$ $C_L = 15\text{ pF}^{(1) (2)}$	100-mV input step with 5-mV overdrive	1.3	μs
		TTL-level input step	0.3	

- (1) C_L includes probe and jig capacitance.
 (2) The response time specified is the interval between the input step function and the instant when the output crosses 1.4 V .

TYPICAL CHARACTERISTICS

**SUPPLY CURRENT
vs
SUPPLY VOLTAGE**

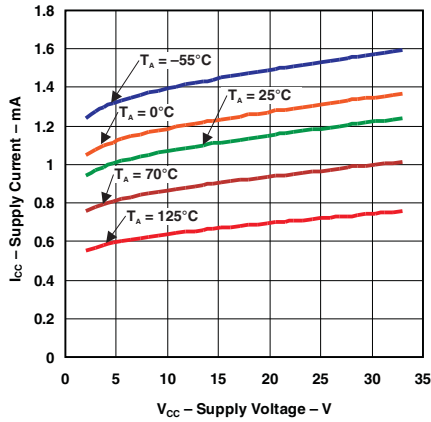

**INPUT BIAS CURRENT
vs
SUPPLY VOLTAGE**

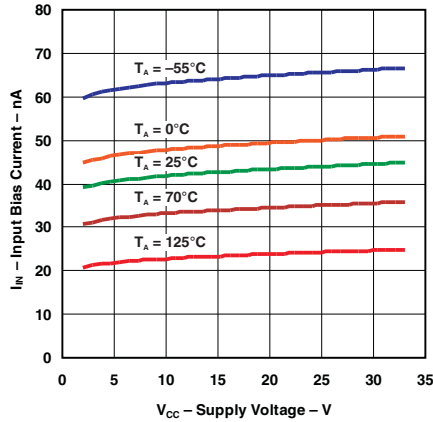

OUTPUT SATURATION VOLTAGE

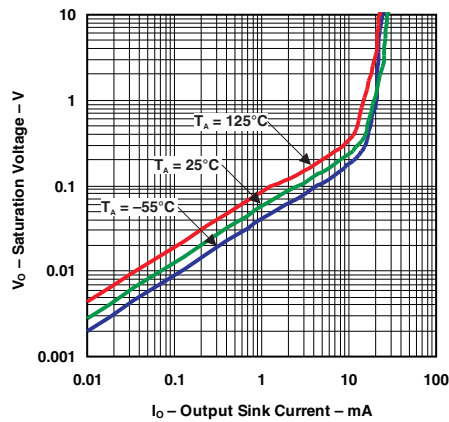

TYPICAL CHARACTERISTICS (continued)

**RESPONSE TIME FOR VARIOUS OVERDRIVES
NEGATIVE TRANSITION**

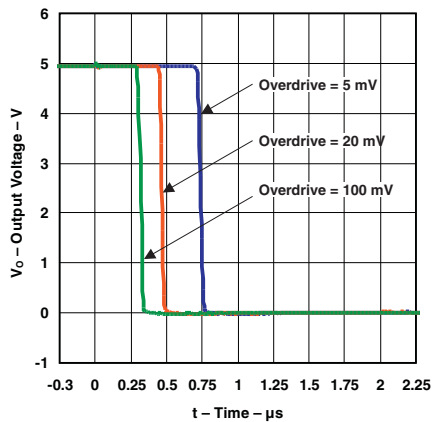

**RESPONSE TIME FOR VARIOUS OVERDRIVES
POSITIVE TRANSITION**

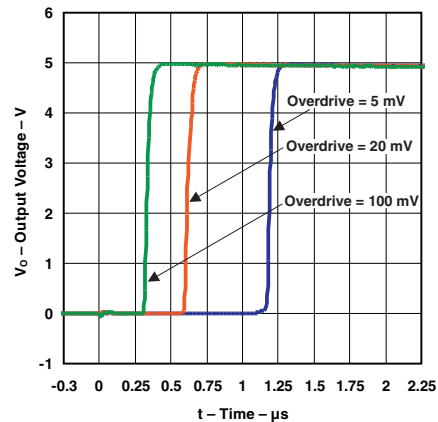

Important statement:

Huaguan Semiconductor Co,Ltd. reserves the right to change the products and services provided without notice. Customers should obtain the latest relevant information before ordering, and verify the timeliness and accuracy of this information.

Customers are responsible for complying with safety standards and taking safety measures when using our products for system design and machine manufacturing to avoid potential risks that may result in personal injury or property damage.

Our products are not licensed for applications in life support, military, aerospace, etc., so we do not bear the consequences of the application of these products in these fields.

Our documentation is only permitted to be copied without any tampering with the content, so we do not accept any responsibility or liability for the altered documents.

X-ON Electronics

Largest Supplier of Electrical and Electronic Components

Click to view similar products for [Analog Comparators](#) category:

Click to view products by [HGSEMI](#) manufacturer:

Other Similar products are found below :

[633740E](#) [ADCMP396ARZ-RL7](#) [NCV2200SN2T1G](#) [NCV2200SQ2T2G](#) [SC339DR2G](#) [LM2901SNG](#) [LM339SNG](#) [AP393AM8G-13](#)
[418524AB](#) [TS393CD C3](#) [LM393SNG](#) [55122](#) [5962-8757203IA](#) [MAX971ESA+T](#) [MAX961ESAT](#) [MAX944ESD+T](#) [MAX931ESAT](#)
[MAX984CPE](#) [MAX9062EBSTG45](#) [MAX9041AEUTT](#) [MAX9022ASAT](#) [RT2902YDT](#) [M38510/11201B2A](#) [NTE911](#) [5962-8751601DA](#)
[5962-8751601CA](#) [MAX961EUA+T](#) [MAX9065EBS+TG45](#) [NCV2202SN2T1G](#) [MAX919ESA+T](#) [LT6700HS6-2#TRMPBF](#) [MAX19005CCS+](#)
[LM339EDR2G](#) [LT6700HS6-2#TRM](#) [NTE919](#) [NTE922](#) [TS883IQ2T](#) [LT6700HVCS6-3#TRMPBF](#) [LT6700HVHS6-3#TRMPBF](#)
[MAX978EEE+T](#) [MAX975ESA+T](#) [MAX9602EUG+T](#) [MAX997EUA+T](#) [MIC841NYC5-T5](#) [LM393WDT](#) [MCP6564T-E/STVAO](#)
[MAX983ESA+T](#) [NCX2200GMAZ](#) [LTC1540CMS8#PBF](#) [MC10E1651FNG](#)