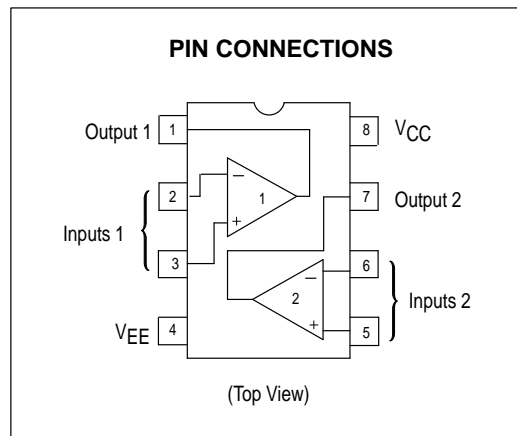
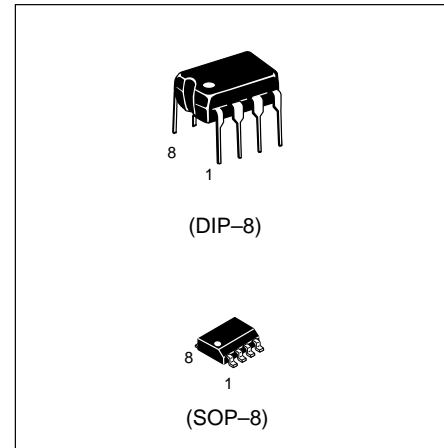


## Dual Low Noise, Audio Amplifier

The LM833 is a standard low-cost monolithic dual general-purpose operational amplifier employing Bipolar technology with innovative high-performance concepts for audio systems applications. With high frequency PNP transistors, the LM833 offers low voltage noise ( $4.5 \text{ nV}/\sqrt{\text{Hz}}$ ), 15 MHz gain bandwidth product,  $7.0 \text{ V}/\mu\text{s}$  slew rate, 0.3 mV input offset voltage with  $2.0 \mu\text{V}/^\circ\text{C}$  temperature coefficient of input offset voltage. The LM833 output stage exhibits no deadband crossover distortion, large output voltage swing, excellent phase and gain margins, low open loop high frequency output impedance and symmetrical source/sink AC frequency response.

The LM833 is specified over the automotive temperature range and is available in the plastic DIP and SOP-8 packages (M and N suffixes).

- Low Voltage Noise:  $4.5 \text{ nV}/\sqrt{\text{Hz}}$
- High Gain Bandwidth Product: 15 MHz
- High Slew Rate:  $7.0 \text{ V}/\mu\text{s}$
- Low Input Offset Voltage: 0.3 mV
- Low T.C. of Input Offset Voltage:  $2.0 \mu\text{V}/^\circ\text{C}$
- Low Distortion: 0.002%
- Excellent Frequency Stability
- Dual Supply Operation



### MAXIMUM RATINGS

Rating	Symbol	Value	Unit
Supply Voltage (V <sub>CC</sub> to V <sub>EE</sub> )	V <sub>S</sub>	+36	V
Input Differential Voltage Range (Note 1)	V <sub>IDR</sub>	30	V
Input Voltage Range (Note 1)	V <sub>IR</sub>	±15	V
Output Short Circuit Duration (Note 2)	t <sub>SC</sub>	Indefinite	
Operating Ambient Temperature Range	T <sub>A</sub>	-40 to +85	°C
Operating Junction Temperature	T <sub>J</sub>	+150	°C
Storage Temperature	T <sub>stg</sub>	-60 to +150	°C
Maximum Power Dissipation (Notes 2 and 3)	P <sub>D</sub>	500	mW

- NOTES:**
1. Either or both input voltages must not exceed the magnitude of V<sub>CC</sub> or V<sub>EE</sub>.
  2. Power dissipation must be considered to ensure maximum junction temperature (T<sub>J</sub>) is not exceeded (see power dissipation performance characteristic).
  3. Maximum value at T<sub>A</sub> ≤ 85°C.

### ORDERING INFORMATION

DEVICE	Package Type	MARKING	Packing	Packing Qty
LM833N	DIP8	LM833	TUBE	2000/box
LM833M/TR	SOP8	LM833	REEL	2500/reel

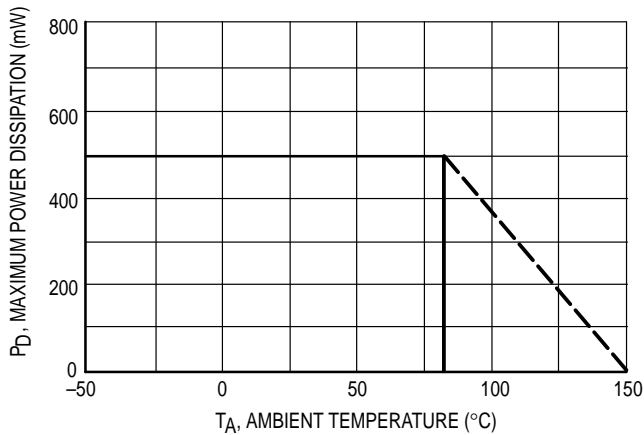
**ELECTRICAL CHARACTERISTICS** ( $V_{CC} = +15\text{ V}$ ,  $V_{EE} = -15\text{ V}$ ,  $T_A = 25^\circ\text{C}$ , unless otherwise noted.)

Characteristic	Symbol	Min	Typ	Max	Unit
Input Offset Voltage ( $R_S = 10\ \Omega$ , $V_O = 0\text{ V}$ )	$V_{IO}$	–	0.3	5.0	mV
Average Temperature Coefficient of Input Offset Voltage $R_S = 10\ \Omega$ , $V_O = 0\text{ V}$ , $T_A = T_{low}$ to $T_{high}$	$\Delta V_{IO}/\Delta T$	–	2.0	–	$\mu\text{V}/^\circ\text{C}$
Input Offset Current ( $V_{CM} = 0\text{ V}$ , $V_O = 0\text{ V}$ )	$I_{IO}$	–	10	200	nA
Input Bias Current ( $V_{CM} = 0\text{ V}$ , $V_O = 0\text{ V}$ )	$I_{IB}$	–	300	1000	nA
Common Mode Input Voltage Range	$V_{ICR}$	– –12	+14 –14	+12 –	V
Large Signal Voltage Gain ( $R_L = 2.0\text{ k}\Omega$ , $V_O = \pm 10\text{ V}$ )	$A_{VOL}$	90	110	–	dB
Output Voltage Swing: $R_L = 2.0\text{ k}\Omega$ , $V_{ID} = 1.0\text{ V}$ $R_L = 2.0\text{ k}\Omega$ , $V_{ID} = 1.0\text{ V}$ $R_L = 10\text{ k}\Omega$ , $V_{ID} = 1.0\text{ V}$ $R_L = 10\text{ k}\Omega$ , $V_{ID} = 1.0\text{ V}$	$V_{O+}$ $V_{O-}$ $V_{O+}$ $V_{O-}$	10 – 12 –	13.7 –14.1 13.9 –14.7	– –10 – –12	V
Common Mode Rejection ( $V_{in} = \pm 12\text{ V}$ )	CMR	80	100	–	dB
Power Supply Rejection ( $V_S = 15\text{ V}$ to $5.0\text{ V}$ , $-15\text{ V}$ to $-5.0\text{ V}$ )	PSR	80	115	–	dB
Power Supply Current ( $V_O = 0\text{ V}$ , Both Amplifiers)	$I_D$	–	4.0	8.0	mA

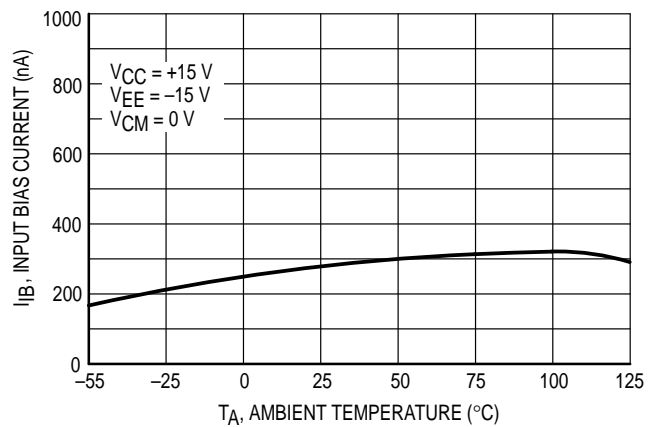
**AC ELECTRICAL CHARACTERISTICS** ( $V_{CC} = +15\text{ V}$ ,  $V_{EE} = -15\text{ V}$ ,  $T_A = 25^\circ\text{C}$ , unless otherwise noted.)

Characteristic	Symbol	Min	Typ	Max	Unit
Slew Rate ( $V_{in} = -10\text{ V}$ to $+10\text{ V}$ , $R_L = 2.0\text{ k}\Omega$ , $A_V = +1.0$ )	SR	5.0	7.0	–	$\text{V}/\mu\text{s}$
Gain Bandwidth Product ( $f = 100\text{ kHz}$ )	GBW	10	15	–	MHz
Unity Gain Frequency (Open Loop)	$f_U$	–	9.0	–	MHz
Unity Gain Phase Margin (Open Loop)	$\theta_m$	–	60	–	Deg
Equivalent Input Noise Voltage ( $R_S = 100\ \Omega$ , $f = 1.0\text{ kHz}$ )	$e_n$	–	4.5	–	$\text{nV}/\sqrt{\text{Hz}}$
Equivalent Input Noise Current ( $f = 1.0\text{ kHz}$ )	$i_n$	–	0.5	–	$\text{pA}/\sqrt{\text{Hz}}$
Power Bandwidth ( $V_O = 27\text{ V}_{pp}$ , $R_L = 2.0\text{ k}\Omega$ , $\text{THD} \leq 1.0\%$ )	BWP	–	120	–	kHz
Distortion ( $R_L = 2.0\text{ k}\Omega$ , $f = 20\text{ Hz}$ to $20\text{ kHz}$ , $V_O = 3.0\text{ V}_{rms}$ , $A_V = +1.0$ )	THD	–	0.002	–	%
Channel Separation ( $f = 20\text{ Hz}$ to $20\text{ kHz}$ )	$C_S$	–	–120	–	dB

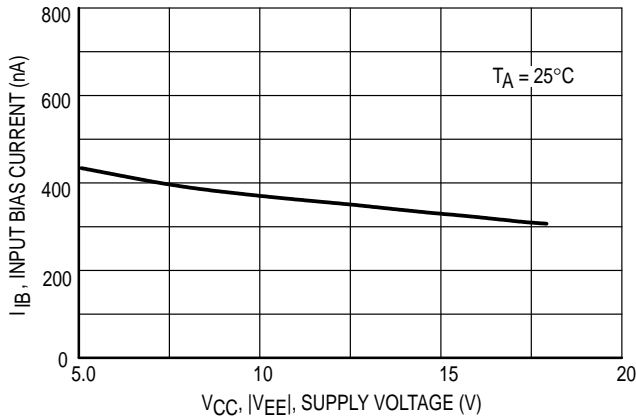
**Figure 1. Maximum Power Dissipation versus Temperature**



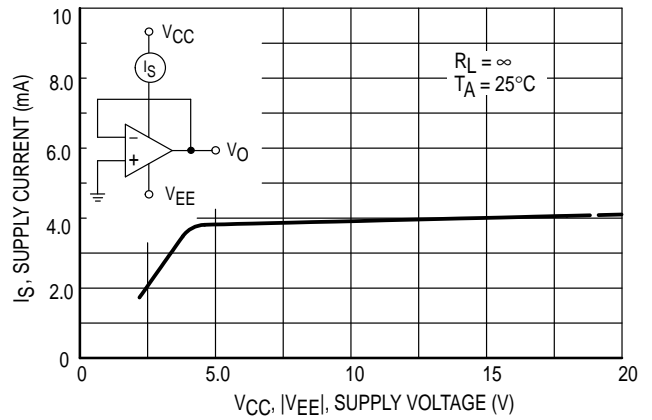
**Figure 2. Input Bias Current versus Temperature**



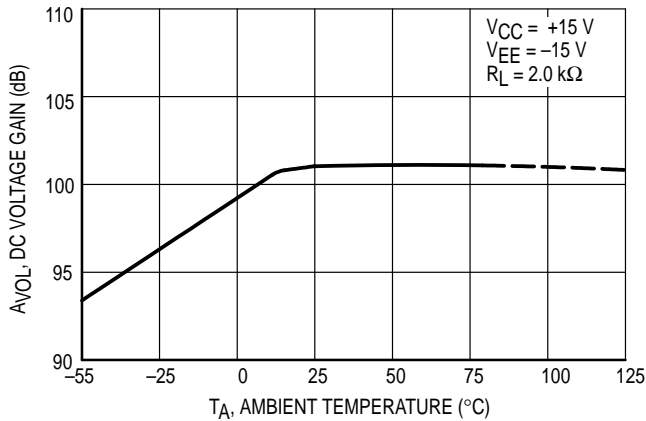
**Figure 3. Input Bias Current versus Supply Voltage**



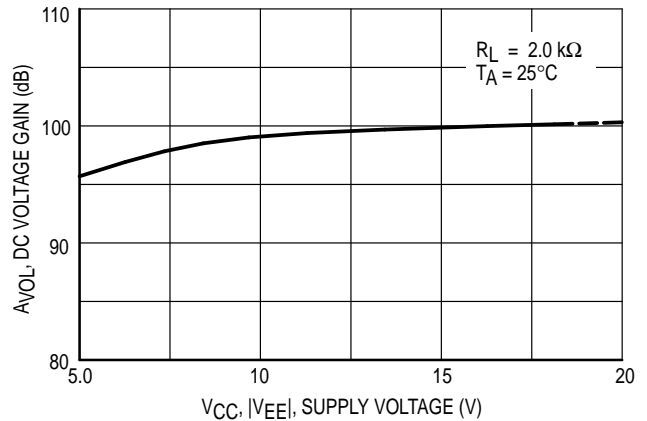
**Figure 4. Supply Current versus Supply Voltage**



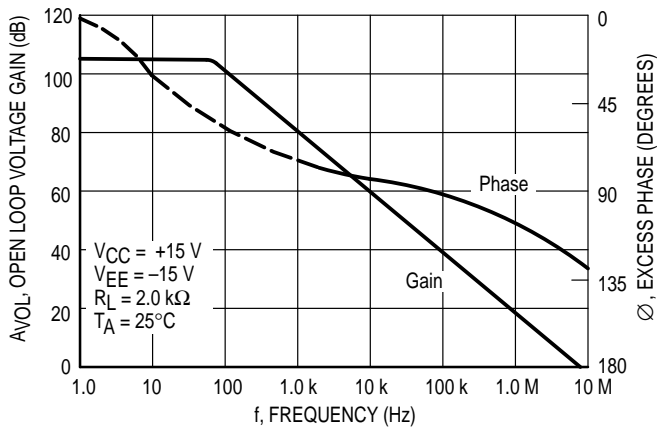
**Figure 5. DC Voltage Gain versus Temperature**



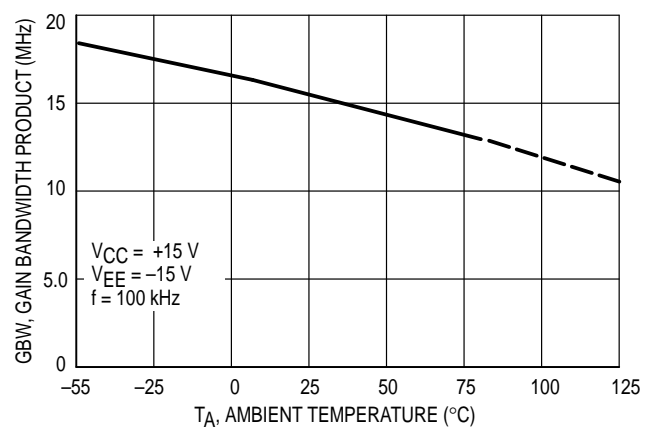
**Figure 6. DC Voltage Gain versus Supply Voltage**



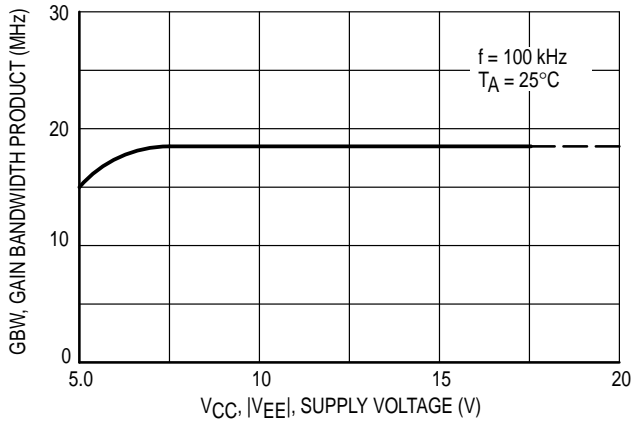
**Figure 7. Open Loop Voltage Gain and Phase versus Frequency**



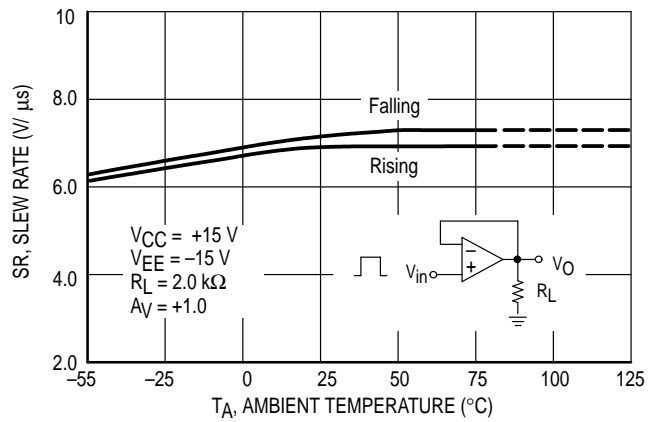
**Figure 8. Gain Bandwidth Product versus Temperature**



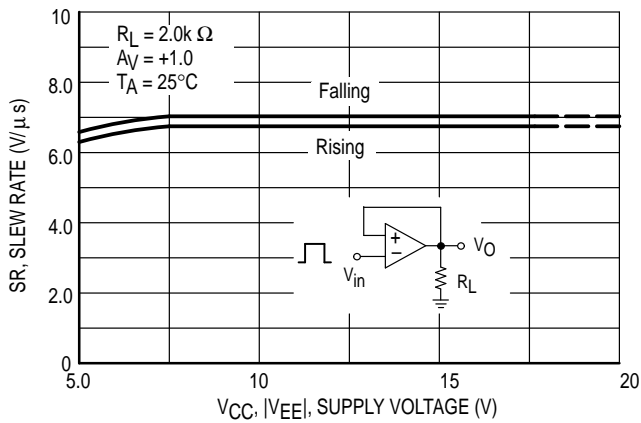
**Figure 9. Gain Bandwidth Product versus Supply Voltage**



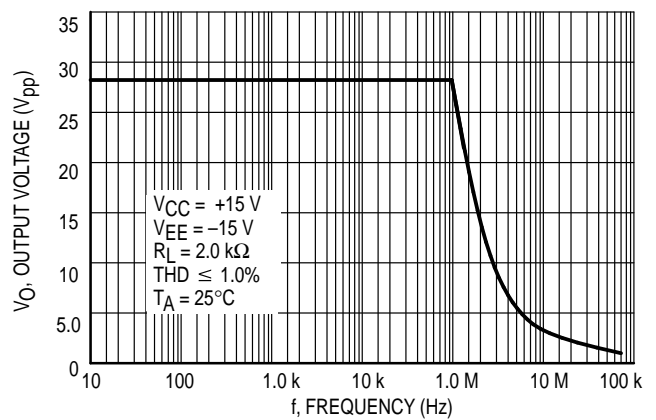
**Figure 10. Slew Rate versus Temperature**



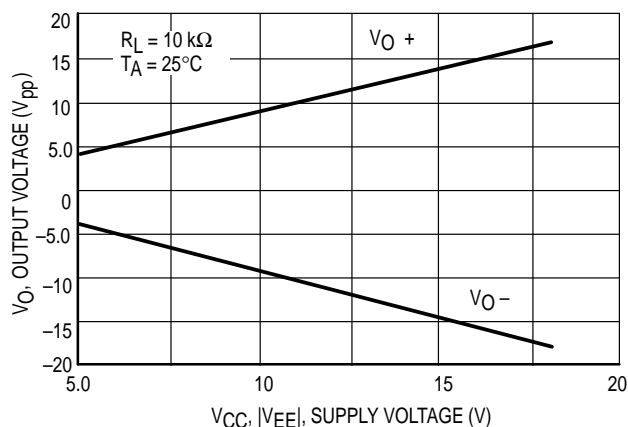
**Figure 11. Slew Rate versus Supply Voltage**



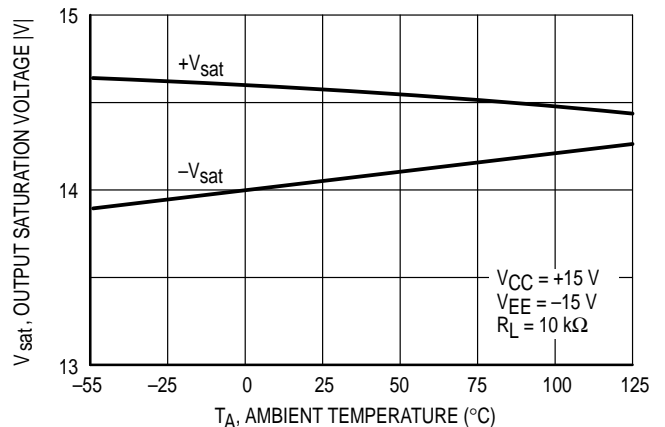
**Figure 12. Output Voltage versus Frequency**



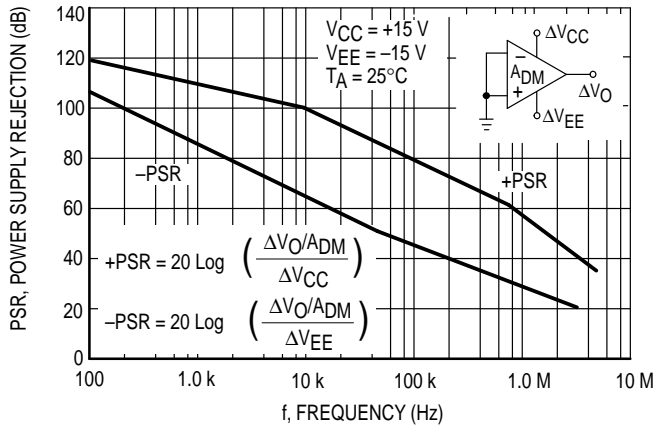
**Figure 13. Maximum Output Voltage versus Supply Voltage**



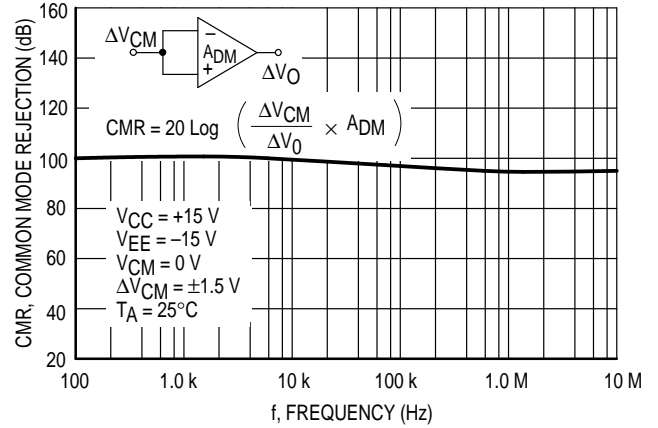
**Figure 14. Output Saturation Voltage versus Temperature**



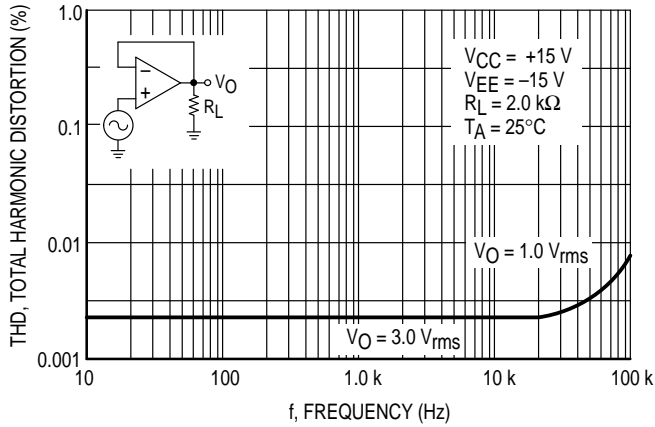
**Figure 15. Power Supply Rejection versus Frequency**



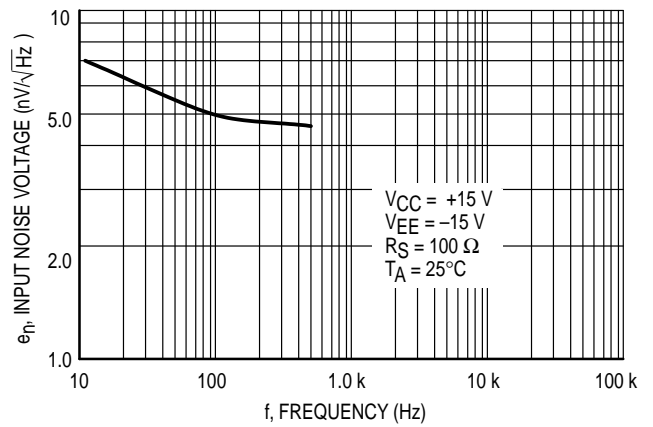
**Figure 16. Common Mode Rejection versus Frequency**



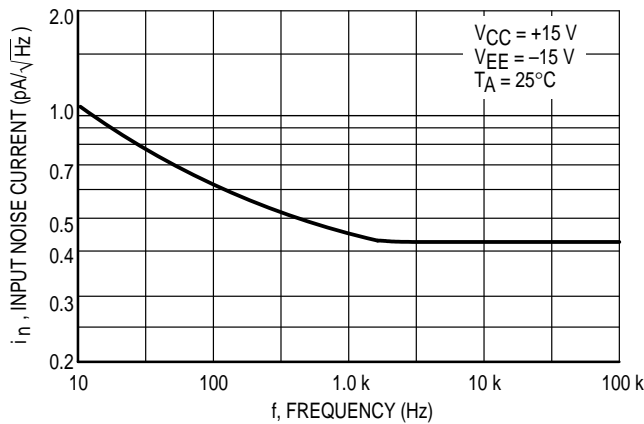
**Figure 17. Total Harmonic Distortion versus Frequency**



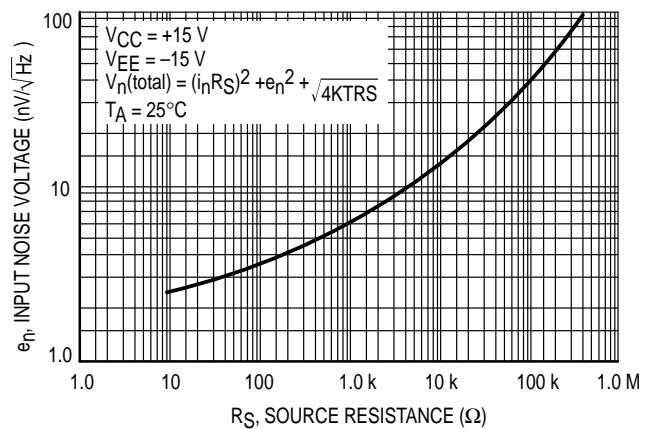
**Figure 18. Input Referred Noise Voltage versus Frequency**



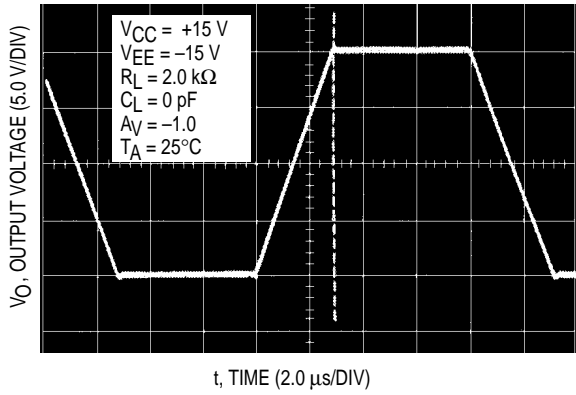
**Figure 19. Input Referred Noise Current versus Frequency**



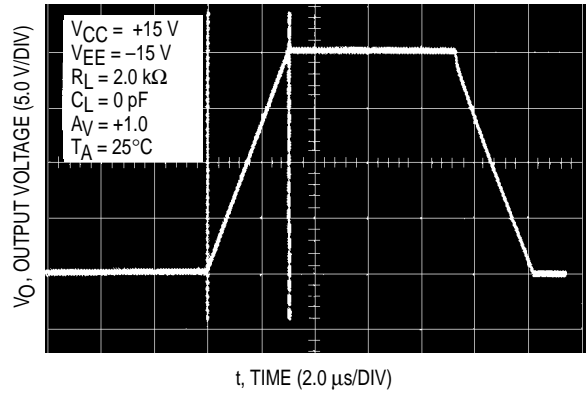
**Figure 20. Input Referred Noise Voltage versus Source Resistance**



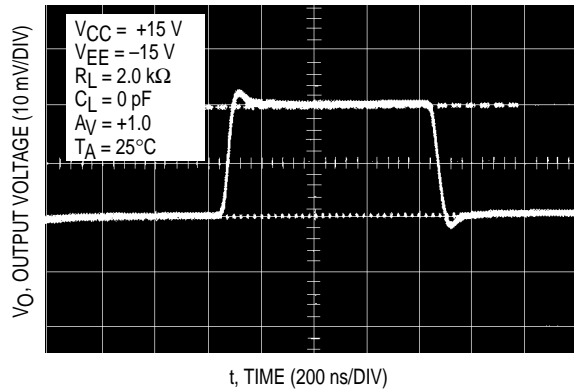
**Figure 21. Inverting Amplifier**



**Figure 22. Noninverting Amplifier Slew Rate**

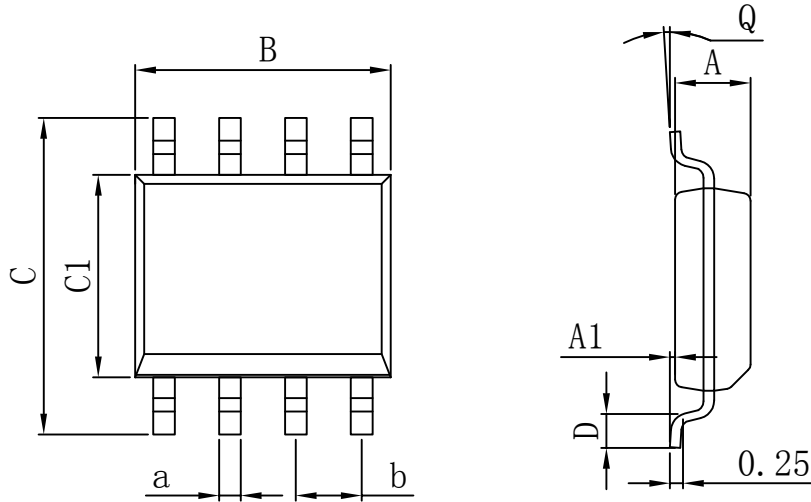


**Figure 23. Noninverting Amplifier Overshoot**



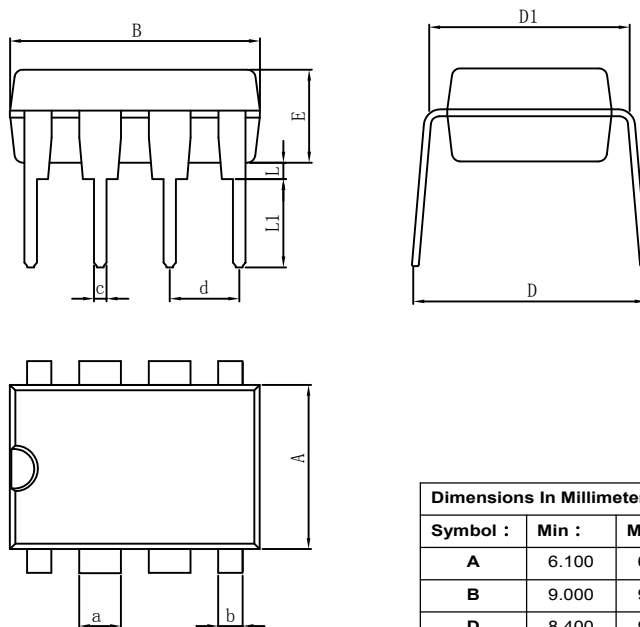
PACKAGE

SOP8



Dimensions In Millimeters					
Symbol :	Min :	Max :	Symbol :	Min :	Max :
A	1.250	1.570	D	0.400	0.950
A1	0.100	0.250	Q	0°	8°
B	4.800	5.100	a	0.420 TYP	
C	5.800	6.250	b	1.270 TYP	
C1	3.800	4.000			

DIP8



Dimensions In Millimeters					
Symbol :	Min :	Max :	Symbol :	Min :	Max :
A	6.100	6.680	L1	3.000	3.600
B	9.000	9.500	a	1.524 TYP	
D	8.400	9.000	b	0.889 TYP	
D1	7.420	7.820	c	0.457 TYP	
E	3.100	3.550	d	2.540 TYP	
L	0.500	0.700			

Important statement:

Huaguan Semiconductor Co,Ltd. reserves the right to change the products and services provided without notice. Customers should obtain the latest relevant information before ordering, and verify the timeliness and accuracy of this information.

Customers are responsible for complying with safety standards and taking safety measures when using our products for system design and machine manufacturing to avoid potential risks that may result in personal injury or property damage.

Our products are not licensed for applications in life support, military, aerospace, etc., so we do not bear the consequences of the application of these products in these fields.

Huaguan Semiconductor Co,Ltd. the performance of the semiconductor products produced by the company can reach the performance indicators that can be applied at the time of sales. the use of testing and other quality control technologies is limited to the quality assurance scope of Huaguan semiconductor. Not all parameters of each device need to be tested. The above documents are for reference only, and all are subject to the physical parameters.

Our documentation is only permitted to be copied without any tampering with the content, so we do not accept any responsibility or liability for the altered documents.



## X-ON Electronics

Largest Supplier of Electrical and Electronic Components

*Click to view similar products for [Operational Amplifiers - Op Amps](#) category:*

*Click to view products by [HGSEMI](#) manufacturer:*

Other Similar products are found below :

[430227FB](#) [LT1678IS8](#) [NCV33202DMR2G](#) [NJM324E](#) [M38510/13101BPA](#) [NTE925](#) [AZV358MTR-G1](#) [AP4310AUMTR-AG1](#)  
[AZV358MMTR-G1](#) [SCY33178DR2G](#) [NCV20034DR2G](#) [NTE778S](#) [NTE871](#) [NTE937](#) [NJU7057RB1-TE2](#) [SCY6358ADR2G](#)  
[NJM2904CRB1-TE1](#) [UPC4570G2-E1-A](#) [UPC4741G2-E1-A](#) [NJM8532RB1-TE1](#) [EL2250CS](#) [EL5100IS](#) [EL5104IS](#) [EL5127CY](#) [EL5127CYZ](#)  
[EL5133IW](#) [EL5152IS](#) [EL5156IS](#) [EL5162IS](#) [EL5202IY](#) [EL5203IY](#) [EL5204IY](#) [EL5210CS](#) [EL5210CYZ](#) [EL5211IYE](#) [EL5220CY](#)  
[EL5223CLZ](#) [EL5223CR](#) [EL5224ILZ](#) [EL5227CLZ](#) [EL5227CRZ](#) [EL5244CS](#) [EL5246CS](#) [EL5246CSZ](#) [EL5250IY](#) [EL5251IS](#) [EL5257IS](#)  
[EL5260IY](#) [EL5261IS](#) [EL5300IU](#)