

3A Fast-Response LDO Regulator

Features

- High-current capability
- 3A over full temperature range
- Low-dropout voltage of 450mV at full load
- Low ground current
- Accurate 1% guaranteed tolerance
- Extremely-fast transient response
- Zero-current shutdown mode
- Error flag signals output out-of-regulation
- Adjustable output voltage
- Packages: TO-263-5、TO-220-5 and TO-252-4

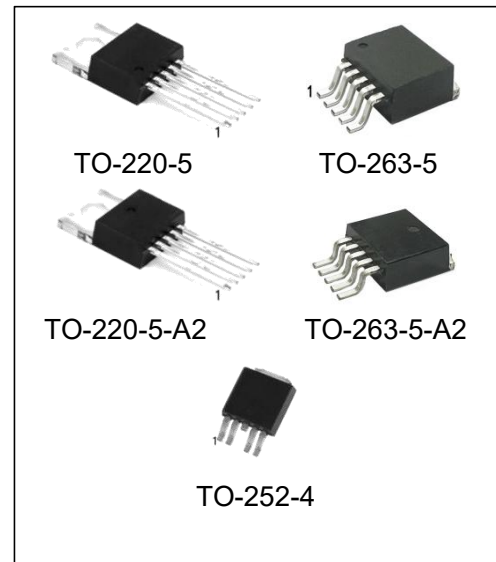

Ordering Information

| DEVICE | Package Type | MARKING | Packing | Packing Qty |
|------------------|----------------------|------------|---------|--------------|
| LP3966T-ADJ | TO-220-5/TO-220-5-A2 | LP3966-ADJ | TUBE | 1000pcs/box |
| LP3966S-ADJ/TR | TO-263-5/TO-263-5-A2 | LP3966-ADJ | REEL | 500pcs/reel |
| LP3966MDT-ADJ/TR | TO-252-4 | LP3966-ADJ | REEL | 2500pcs/reel |

General Description

The LP3966-ADJ is a high-current, low-cost, low-dropout voltage regulator which uses Micrel's proprietary Super β PNP[®] process with a PNP pass element. The 3A LDO regulator features 450mV (full load) dropout voltage and very low ground current. Designed for high-current loads, these devices also find applications in lower current, low dropout-critical systems, where their dropout voltage and ground current values are important attributes.

Along with a total accuracy of $\pm 2\%$ (over temperature, line and load regulation) the regulator features very-fast transient recovery from input voltage surges and output load current changes.

The LP3966-ADJ has an adjustable output which can be set by two external resistors to a voltage between 1.24V to 15V. In addition, the device is fully protected against over current faults, reversed input polarity, reversed lead insertion, and overtemperature operation. A TTL logic enable (EN) pin is available in the LP3966-ADJ to shutdown the regulator. When not used, the device can be set to continuous operation by connecting EN to the input (IN). The LP3966-ADJ is available in the standard and 5-pin TO-263 and TO-252 packages with an operating junction temperature range of -40°C to $+125^{\circ}\text{C}$.

Applications

- Processor peripheral and I/O supplies
- High-efficiency "Green" computer systems
- Automotive electronics
- High-efficiency linear lower supplies
- Battery-powered equipment
- PC add-in cards
- High-efficiency lost-regulator for switching supply

Typical Application

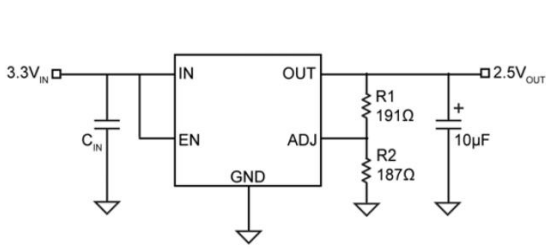

$$V_{OUT} = 1.242 \times \left(\frac{R1}{R2} + 1 \right)$$

LP3966-Adjustable Output Regulator

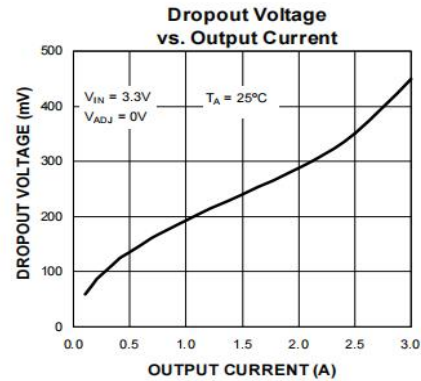

Pin Configuration

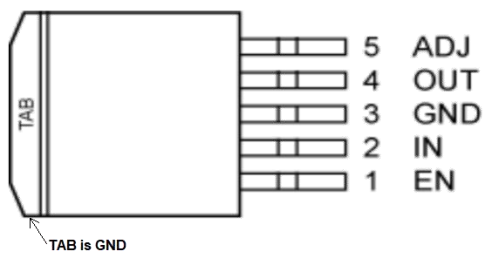

TO-263-5

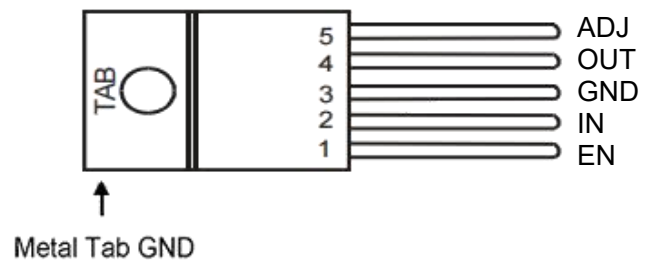

TO-220-5

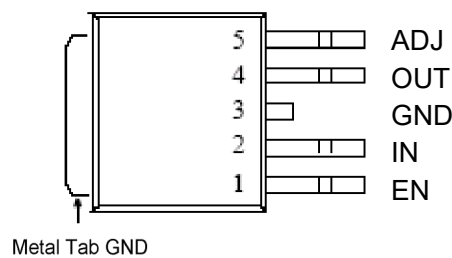

TO-252-4

Pin Description

| Pin Number | Pin Name | Pin Name |
|------------|----------|--|
| 1 | EN | Enable (Input): Active-high CMOS compatible control input. Do not float. |
| 2 | IN | INPUT: Unregulated input, +2.8V to +8V maximum |
| 3, TAB | GND | GND: TAB is also connected internally to the IC's ground on both packages. |
| 4 | OUT | OUTPUT: The regulator output voltage |
| 5 | ADJ | Feedback Voltage: 1.24V feedback from external resistor divider. |

Absolute Maximum Ratings⁽¹⁾

| Condition | | Min | Max |
|---|--------------------------------|--------------------|----------|
| Input Supply Voltage(V_{IN}) ⁽¹⁾ | | 3V | +8V |
| Enable Input Voltage(V_{EN}) | | -0.3V | V_{IN} |
| Lead Temperature (soldering 10sec.) | | - | 245°C |
| Power Dissipation | | Internally Limited | |
| Storage Temperature Range | | -65°C | +150°C |
| ESD Rating ping ⁽³⁾ | | - | - |
| Operating Ratings ⁽²⁾ | Operating Junction Temperature | -40 | +125°C |
| | Operating Input Voltage | 3.3V | 8V |
| Package Thermal Resistance | TO-263 (θJC) | - | 3°C/W |

Electrical Characteristics⁽⁴⁾

$V_{IN} = 4.2V$; $I_{OUT} = 100mA$; $T_A = 25°C$, bold values indicate $-40°C \leq T_J \leq +125°C$, unless noted.

| Parameter | Condition | Min. | Typ. | Max. | Units |
|---|---|------|------|------|---------------|
| Output Voltage | | | | | |
| Output Voltage Accuracy | $100mA \leq I_{OUT} \leq 3A$, $(V_{OUT} + 1V) \leq V_{IN} \leq 8V$ | -2 | | 2 | % |
| Line Regulation | $I_{OUT} = 100mA$, $(V_{OUT} + 1V) \leq V_{IN} \leq 8V$ | | 0.1 | 0.5 | % |
| Load Regulation | $V_{IN} = V_{OUT} + 1V$, $100mA \leq I_{OUT} \leq 3A$ | | 0.2 | 1 | % |
| Dropout Voltage | $\Delta V_{OUT} = -1\%$ ⁽⁶⁾ | | | | mV |
| | $I_{OUT} = 100mA$ | | 80 | 200 | |
| | $I_{OUT} = 750mA$ | | 220 | | |
| | $I_{OUT} = 1.5A$ | | 275 | | |
| | $I_{OUT} = 3A$ | | 450 | 800 | |
| Ground Current | | | | | |
| Ground Current | $I_{OUT} = 750mA$, $V_{IN} = V_{OUT} + 1V$ | | 5 | 20 | mA |
| | $I_{OUT} = 1.5A$ | | 15 | | |
| | $I_{OUT} = 3A$ | | 60 | 150 | |
| IGRNDDO Ground Pin Current @ Dropout | $V_{IN} = 0.5V$ less than specified $V_{OUT} \times I_{OUT} = 10mA$ | | 2 | | |
| Current Limit | $V_{OUT} = 0V$ ⁽⁷⁾ | 3 | 4 | | A |
| e_n , Output Noise Voltage (10Hz to 100kHz) | $C_L = 10\mu F$ | | 400 | | μV (rms) |
| | $I_L = 100mA$ | | 260 | | |
| Ground Pin Current in Shutdown | Input Voltage $V_{IN} = 8V$ | | 32 | | μA |

Electrical Characteristics⁽⁴⁾ (Continued)
 $V_{IN} = 4.2V$; $I_{OUT} = 100mA$; $T_A = 25^{\circ}C$, bold values indicate $-40^{\circ}C \leq T_J \leq +125^{\circ}C$, unless noted.

| Reference | | | | | |
|--------------------------------------|-----------------|-------|----|-------|---------|
| Reference Voltage | (8) | 1.215 | | 1.267 | V |
| Adjust Pin Bias Current | | | 40 | | nA |
| | | | | 120 | |
| ENABLE Input | | | | | |
| Input Logic Voltage | Low (OFF) | | | 0.8 | V |
| | High (ON) | 2.4 | | | |
| Enable Pin Input Current | $V_{EN} = 8V$ | | 15 | 30 | μA |
| | | | | 75 | |
| | $V_{EN} = 0.8V$ | | | 2 | |
| | | | | 4 | |
| Regulator Output Current in Shutdown | (10) | | 10 | | μA |
| | | | | 20 | |

Notes:

- Exceeding the absolute maximum rating may damage the device.
- The device is not guaranteed to function outside its operating rating.
- Devices are ESD sensitive. Handling precautions recommended. Human body model, 1.5k in series with 100pF.
- Specification for packaged product only
- Output voltage temperature coefficient is defined as the worst case voltage change divided by the total temperature change.
- Dropout voltage is defined as the input-to-output differential when output voltage drops to 99% of its normal value with $V_{OUT} + 1V$ applied to V_{IN} .
- $V_{IN} = V_{OUT} \text{ (nominal)} + 1V$. For example, use $V_{IN} = 4.3V$ for a 3.3V regulator or use 6V for a 5V regulator. Employ pulse testing procedure for current limit.
- $V_{REF} \leq V_{OUT} \leq V_{IN} - 1$, $3V \leq V_{OUT} \leq 8V$, $10mA \leq I_L \leq I_{FL}$, $T_J \leq T_{Jmax}$.
- Thermal regulation is defined as the change in the output voltage at a time T after a change in power dissipation is applied, excluding load or line regulation effects. Specifications are for a 250mA load pulse at $V_{IN} = 8V$ (a 4W pulse) for $T = 10ms$.
- $V_{EN} \leq 0.8V$, $V_{IN} \leq 8V$ and $V_{OUT} = 0V$.

Typical Characteristics

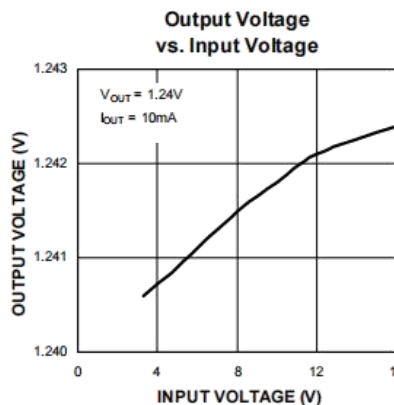
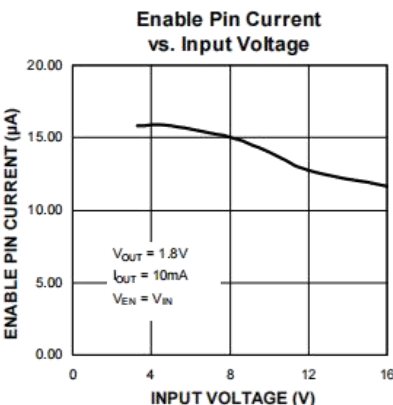
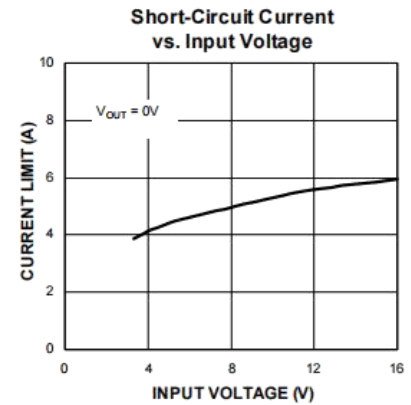
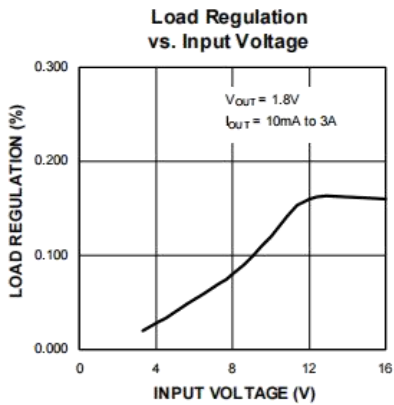
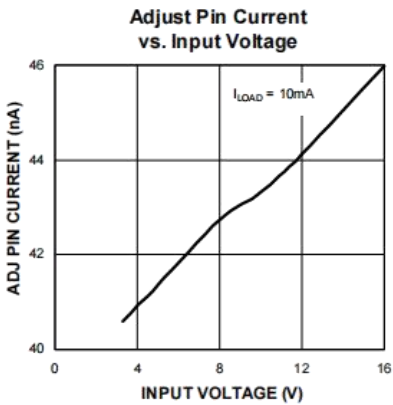
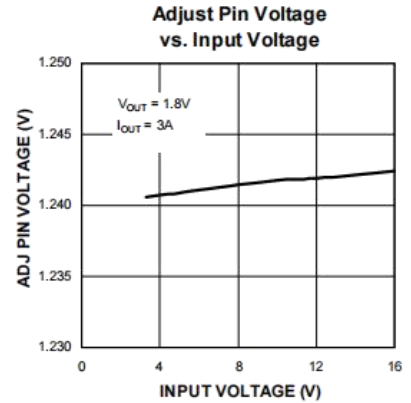
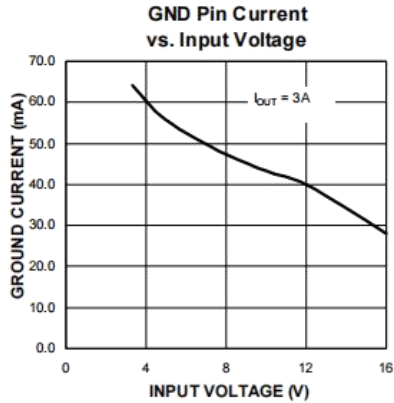
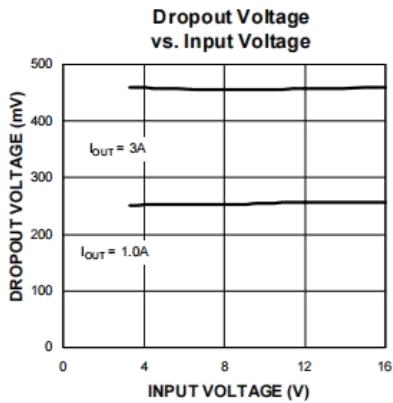

Typical Characteristics (Continued)

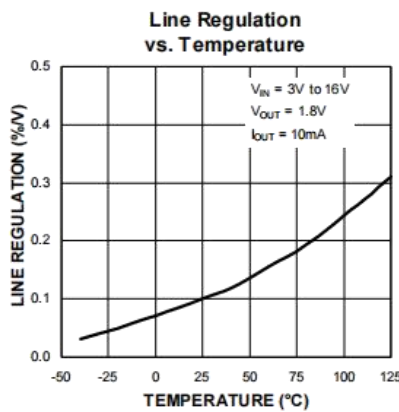
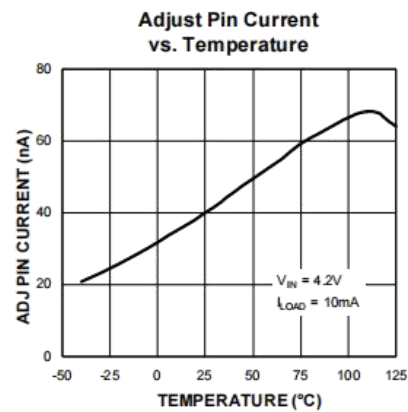
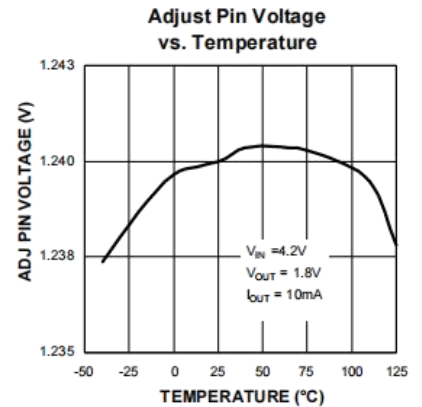
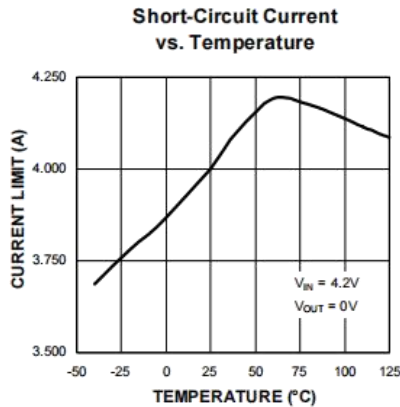
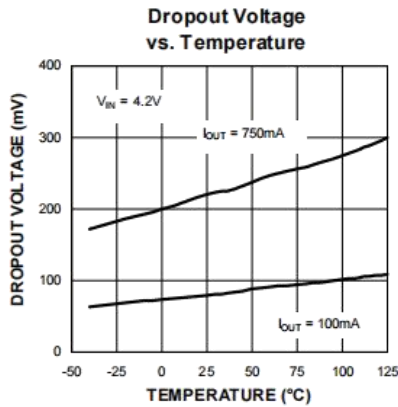
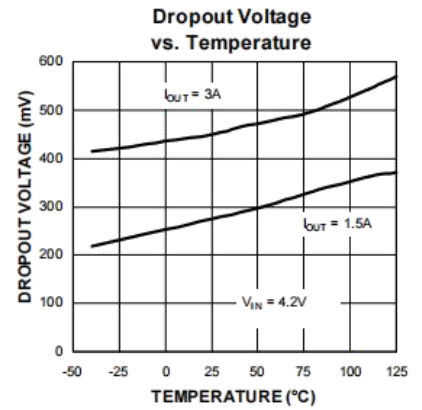
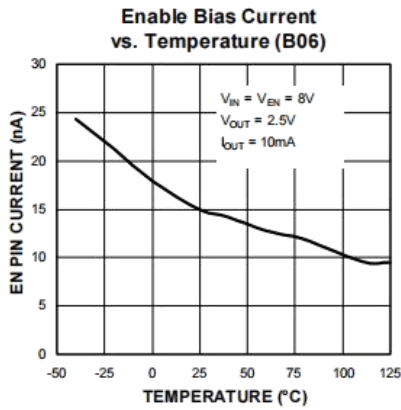
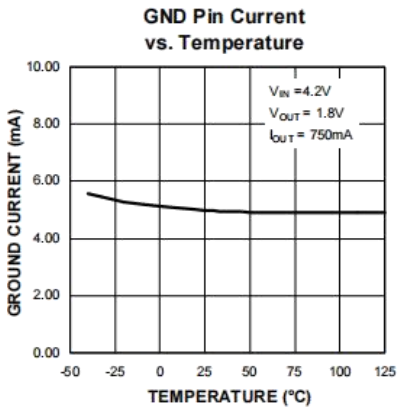

Typical Characteristics (Continued)

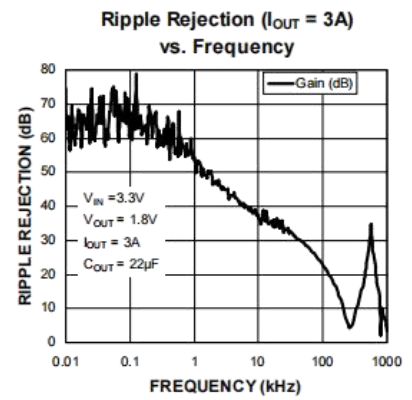
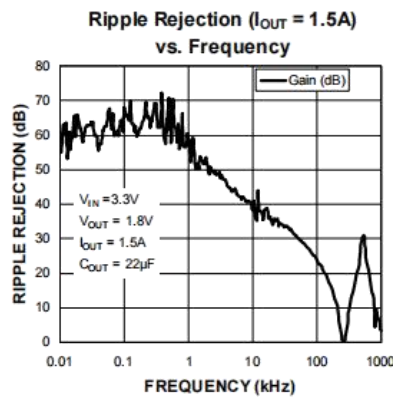
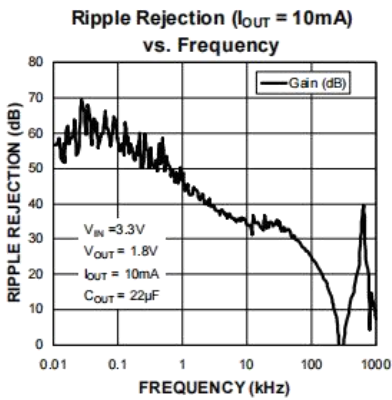
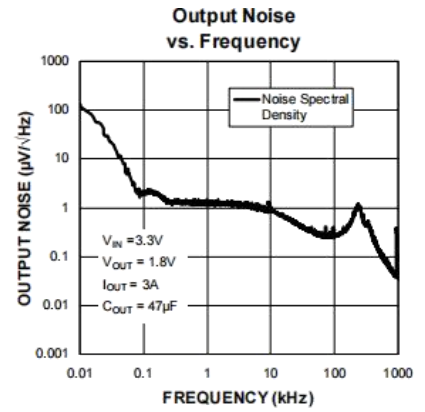
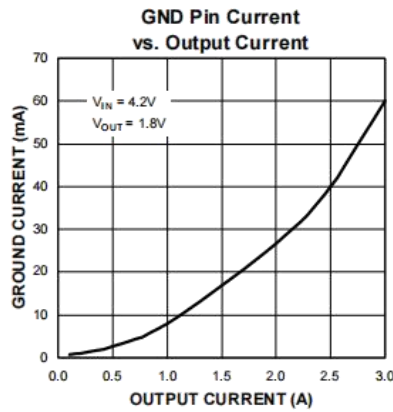
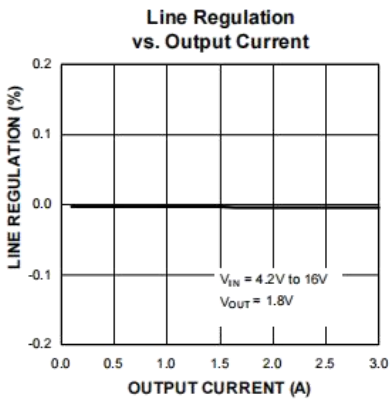
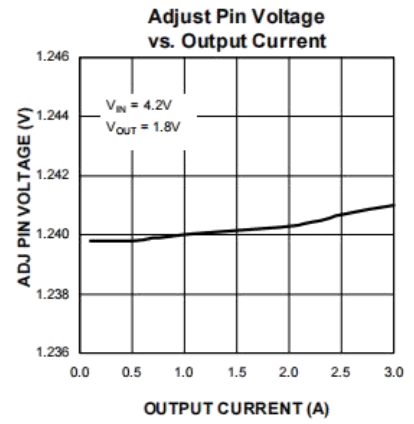
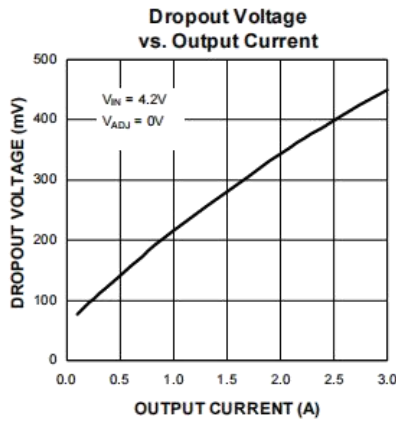
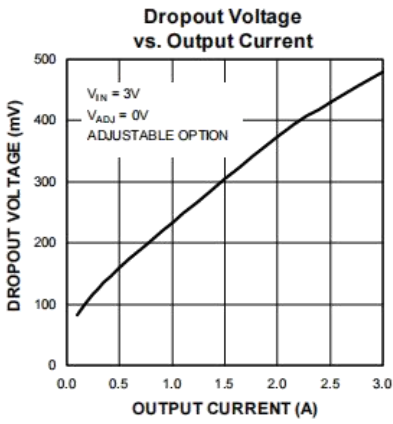

Functional Characteristics

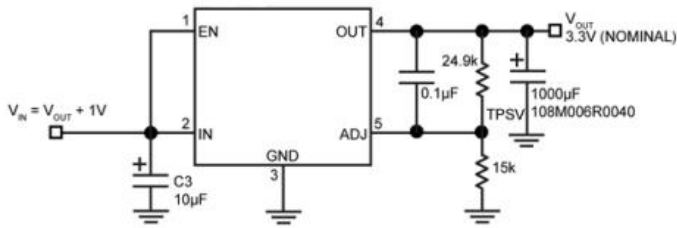
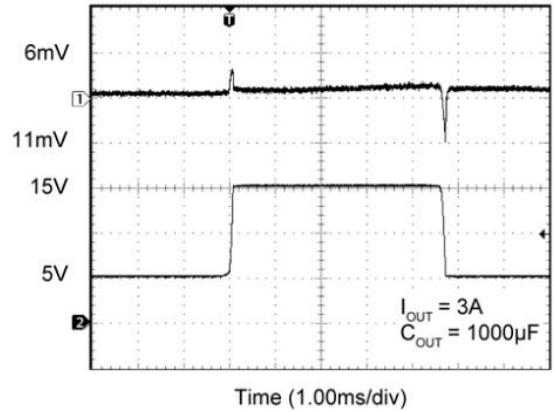
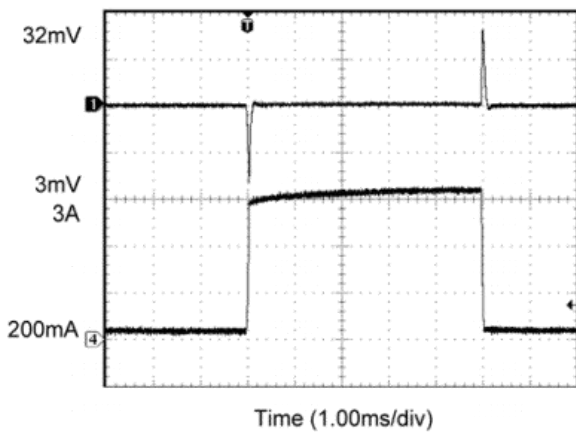

Figure 2. LP3966-ADJ Load Transient Response Test

LP3966-ADJ Line Transient Response with 3A Load, 100µF Output Capacitance



LP3966-ADJ Load Transient Response



LP3966-ADJ Line Transient Response with 3A Load, 100µF Output Capacitance

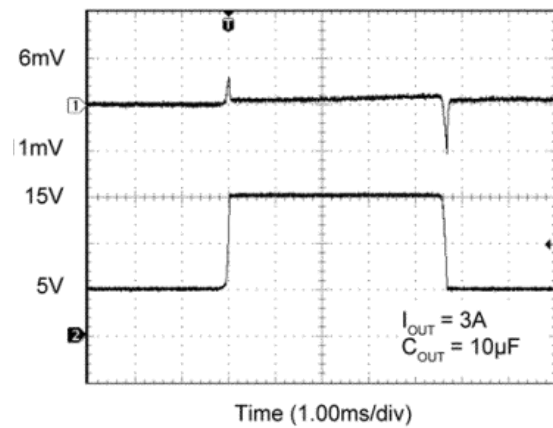

Functional Diagram

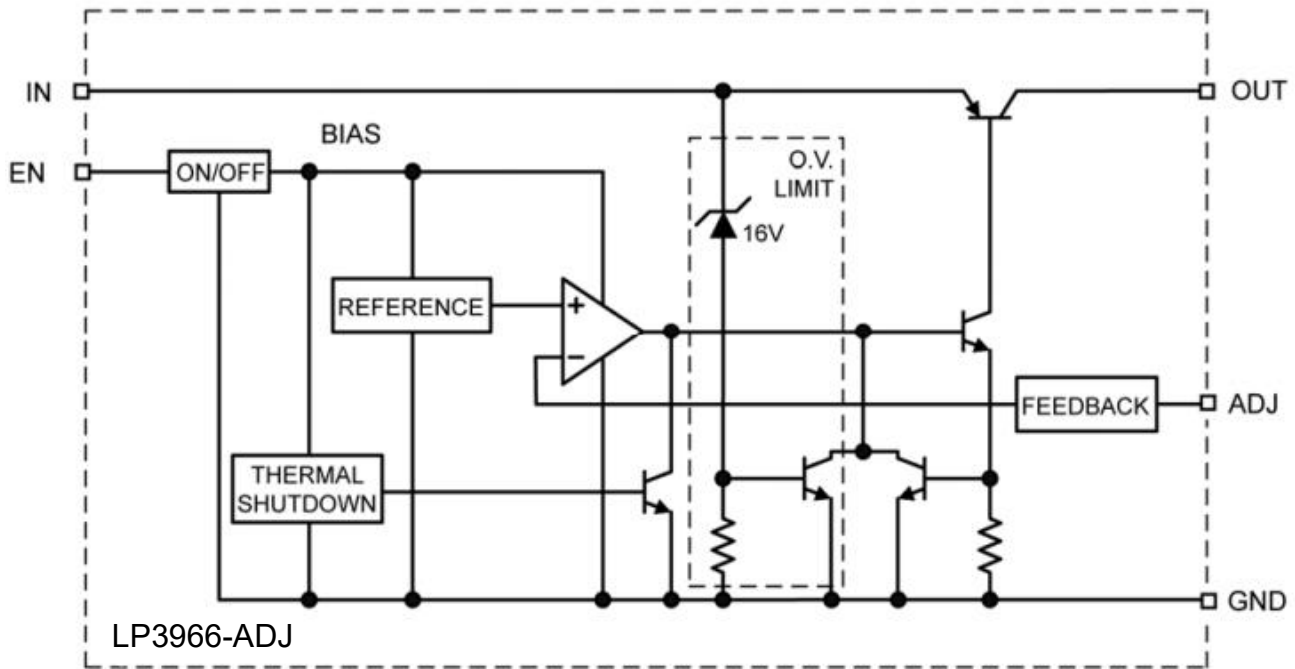

Application Information

The LP3966-ADJ is a high-performance, low-dropout voltage regulator suitable for all moderate to high-current voltage regulation applications. Its 450mV typical dropout voltage at full load makes it especially valuable in battery-powered systems and as high efficiency noise filters in “post-regulator” applications. Unlike older NPN pass transistor designs, where the minimum dropout voltage is limited by the base-emitter voltage drop and collector-emitter saturation voltage, dropout performance of the PNP output is limited merely by the low V_{CE} saturation voltage.

A trade-off for the low-dropout voltage is a varying base driver requirement. But Micrel’s Super β PNP[®] process reduces this drive requirement to merely 1% of the load current.

The LP3966-ADJ regulator is fully protected from damage due to fault conditions. Current limiting is linear; output current under overload conditions is constant. Thermal shutdown disables the device when the die temperature exceeds the 125°C maximum safe operating temperature. The output structure of the regulators allows voltages in excess of the desired output voltage to be applied without reverse current flow. The LP3966-ADJ offer a logic level ON/OFF control: when disabled, the devices draw nearly zero current.

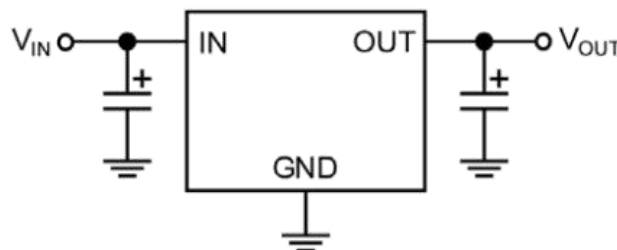

Figure 3. Linear Regulators Require Only Two Capacitors for Operation

Thermal Design

Linear regulators are simple to use. The most complicated set of design parameters to consider are thermal characteristics. Thermal design requires the following application-specific parameters:

- Maximum ambient temperature, T_A
- Output Current, I_{OUT}
- Output Voltage, V_{OUT}
- Input Voltage, V_{IN}

First, we calculate the power dissipation of the regulator from these numbers and the device parameters from this datasheet:

$$P_D = I_{OUT}(1.02V_{IN} - V_{OUT})$$

Where the ground current is approximated by 2% of I_{OUT} .

Then the heat sink thermal resistance is determined with this formula:

$$\theta_{SA} = \frac{T_{JMAX} - T_A}{P_D} - (\theta_{JC} + \theta_{CS})$$

where:

$$T_{JMAX} \leq 125^\circ\text{C} \text{ and } \theta_{CS} \text{ is between } 0 \text{ and } 2^\circ\text{C/W}.$$

The heat sink may be significantly reduced in applications where the minimum input voltage is known and is large compared to the dropout voltage. A series input resistor can be used to drop excessive voltage and distribute the heat between this resistor and the regulator. The low-dropout properties of Micrel Super β PNP[®] regulators allow very significant reductions in regulator power dissipation and the associated heat sink without compromising performance. When this technique is employed, a capacitor of at least 0.1 μ F is needed directly between the input and regulator ground.

With no heat sink in the application, calculate the junction temperature to determine the maximum power dissipation that will be allowed before exceeding the maximum junction temperature of the LP3966-ADJ. The maximum power allowed can be calculated using the thermal resistance (θ_{JA}) of the D-Pak (TO252) adhering to the following criteria for the PCB design: 2 oz. copper and 100mm² copper area for the LP3966-ADJ.

For example, given an expected maximum ambient temperature (T_A) of 75 $^\circ$ C with $V_{IN} = 3.3\text{V}$, $V_{OUT} = 2.5\text{V}$, and $I_{OUT} = 1.5\text{A}$, first calculate the expected P_D using:

$$P_D = (3.3\text{V} - 2.5\text{V}) \times 3\text{A} - (3.3\text{V}) \times (0.016\text{A}) = 2.3472\text{W}$$

Next, calculate the junction temperature for the expected power dissipation:

$$T_J = (\theta_{JA} \times P_D) + T_A = (35^\circ\text{C/W} \times 2.3472\text{W}) + 75^\circ\text{C} = 157.15^\circ\text{C}$$

Now determine the maximum power dissipation allowed that would not exceed the IC's maximum junction temperature (125 $^\circ$ C) without the use of a heat sink by:

$$\begin{aligned} P_{D(MAX)} &= (T_{J(MAX)} - T_A) / \theta_{JA} \\ &= (125^\circ\text{C} - 75^\circ\text{C}) / (35^\circ\text{C/W}) \\ &= 1.428\text{W} \end{aligned}$$

Capacitor Requirements

For stability and minimum output noise, a capacitor on the regulator output is necessary. The value of this capacitor is dependent upon the output current; lower currents allow smaller capacitors. The LP3966-ADJ is stable with a 10 μ F capacitor at full load.

This capacitor need not be an expensive low-ESR type; aluminum electrolytics are adequate. In fact, extremely low-ESR capacitors may contribute to instability. Tantalum capacitors are recommended for systems where fast load transient response is important.

When the regulator is powered from a source with high AC impedance, a 0.1 μ F capacitor connected between input and GND is recommended.

Transient Response and 5V to 3.3V Conversion

The LP3966-ADJ has excellent response to variations in input voltage and load current. By virtue of its low dropout voltage, the device does not saturate into dropout as readily as similar NPN-based designs. A 3.3V output Micrel LDO will maintain full speed and performance with an input supply as low as 4.2V, and will still provide some regulation with supplies down to 3.8V, unlike NPN devices that require 5.1V or more for good performance and become nothing more than a resistor under 4.6V of input. Micrel's PNP regulators provide superior performance in "5V to 3.3V" conversion applications than NPN regulators, especially when all tolerances are considered.

Minimum Load Current

The LP3966-ADJ regulator operates within a specified load range. If the output current is too small, leakage currents dominate and the output voltage rises.

A minimum load current of 10mA is necessary for proper regulation and to swamp any expected leakage current across the operating temperature range.

For best performance the total resistance (R1+R2) should be small enough to pass the minimum regulator load current of 10mA.

Adjustable Regulator Design

The output voltage can be programmed anywhere between 1.25V and the 15V. Two resistors are used.

The resistor values are calculated by:

$$R1=R2 \times \left(\frac{V_{OUT}}{1.240} - 1 \right)$$

where V_{OUT} is the desired output voltage.

Figure 4 shows component definition. Applications with widely varying load currents may scale the resistors to draw the minimum load current required for proper operation (see “Minimum Load Current” section).

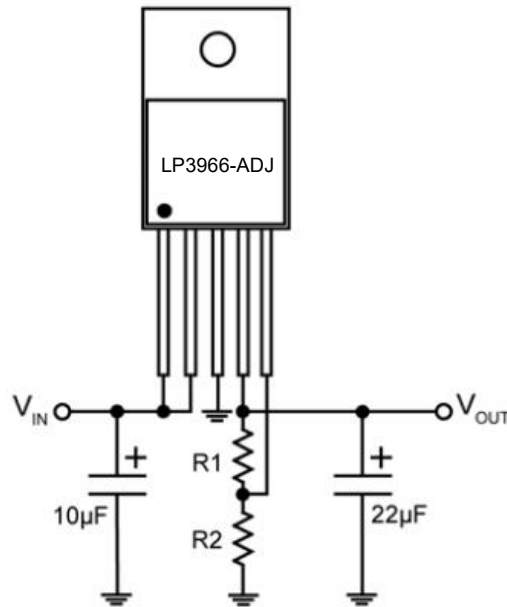

Figure 4. Adjustable Regulator with Resistors

Enable Input

LP3966-ADJ features an enable (EN) input that allows ON/OFF control of the device. Special design allows “zero” current drain when the device is disabled—only microamperes of leakage current flows. The EN input has TTL/CMOS compatible thresholds for simple interfacing with logic, or may be directly tied to VIN.

Enabling the regulator requires approximately 20µA of current into the EN pin.

Physical Dimensions

TO-220-5

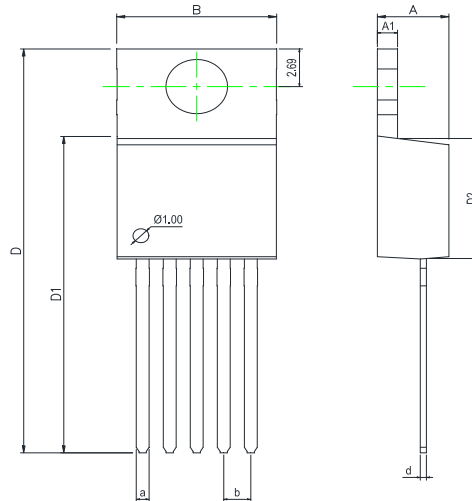
Dimensions In Millimeters(TO-220-5)

| Symbol: | A | A1 | B | D | D1 | D2 | a | d | b |
|---------|------|------|------|------|------|------|------|------|---------|
| Min: | 4.52 | 1.25 | 10 | 28.2 | 22.4 | 8.69 | 0.71 | 0.33 | 1.70BSC |
| Max: | 4.62 | 1.29 | 10.3 | 28.9 | 22.6 | 8.79 | 0.97 | 0.42 | |

TO-263-5

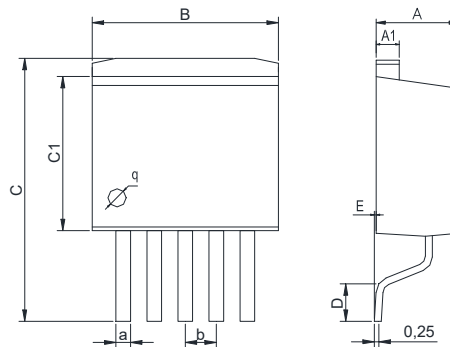
Dimensions In Millimeters(TO-263-5)

| Symbol: | A | A1 | B | C | C1 | D | E | a | b |
|---------|------|------|------|------|------|------|------|------|---------|
| Min: | 4.45 | 1.22 | 10 | 13.7 | 8.40 | 1.90 | 0 | 0.71 | 1.70BSC |
| Max: | 4.62 | 1.32 | 10.4 | 14.6 | 8.90 | 2.10 | 0.20 | 0.97 | |

Physical Dimensions

TO-263-5_(A2)

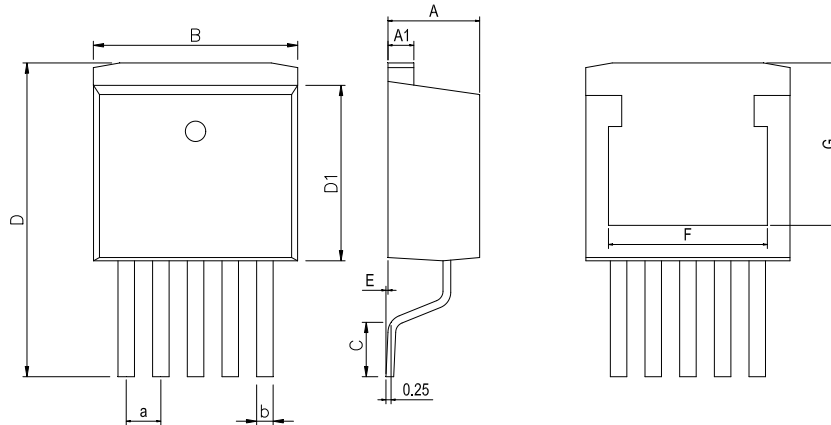

Dimensions In Millimeters(TO-263-5)

| Symbol: | A | A1 | B | C | D | D1 | E | F | G | a | b |
|---------|------|------|------|------|------|------|-------|------|------|------|------|
| Min: | 4.40 | 1.22 | 9.8 | 2.10 | 14.7 | 8.50 | 0 | 7.70 | 7.87 | 0.71 | 1.70 |
| Max: | 4.60 | 1.32 | 10.4 | 2.60 | 15.6 | 9.10 | 0.305 | 7.90 | 8.07 | 0.97 | BSC |

TO-220-5_(A2)

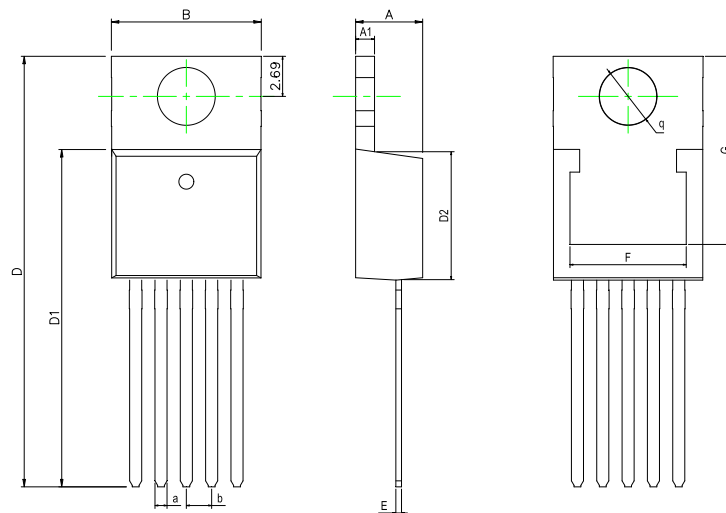

Dimensions In Millimeters(TO-220-5)

| Symbol: | A | A1 | B | D | D1 | D2 | E | F | G | a | b | q |
|---------|------|------|------|------|------|------|------|------|-------|------|------|------|
| Min: | 4.40 | 1.22 | 9.8 | 28.5 | 22.4 | 8.50 | 0.33 | 7.70 | 12.55 | 0.71 | 1.70 | 3.80 |
| Max: | 4.60 | 1.32 | 10.4 | 28.9 | 22.7 | 9.10 | 0.43 | 7.90 | 12.65 | 0.97 | BSC | TYP |

Physical Dimensions

TO-252-4

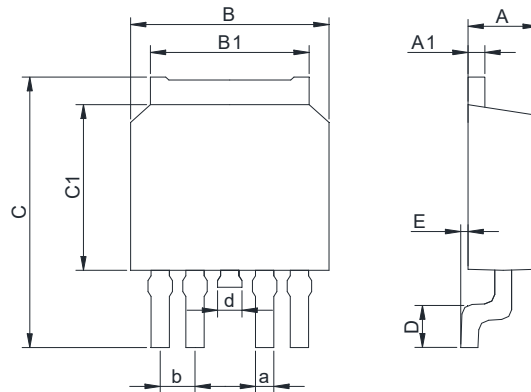

| Dimensions In Millimeters(TO-252-4) | | | | | | | | | | | |
|-------------------------------------|------|------|------|------|------|------|------|------|------|-----|---------|
| Symbol: | A | A1 | B | B1 | C | C1 | D | E | a | d | b |
| Min: | 2.20 | 0.45 | 6.40 | 5.20 | 9.40 | 5.40 | 1.40 | 0 | 0.45 | 0.4 | 1.27BSC |
| Max: | 2.40 | 0.55 | 6.80 | 5.50 | 10.2 | 5.80 | 1.77 | 0.15 | 0.60 | 0.6 | |

Revision History

| DATE | REVISION | PAGE |
|----------|----------|------|
| 2014-8-9 | New | 1-18 |

IMPORTANT STATEMENT:

Huaguan Semiconductor reserves the right to change its products and services without notice. Before ordering, the customer shall obtain the latest relevant information and verify whether the information is up to date and complete. Huaguan Semiconductor does not assume any responsibility or obligation for the altered documents.

Customers are responsible for complying with safety standards and taking safety measures when using Huaguan Semiconductor products for system design and machine manufacturing. You will bear all the following responsibilities: Select the appropriate Huaguan Semiconductor products for your application; Design, validate and test your application; Ensure that your application meets the appropriate standards and any other safety, security or other requirements. To avoid the occurrence of potential risks that may lead to personal injury or property loss.

Huaguan Semiconductor products have not been approved for applications in life support, military, aerospace and other fields, and Huaguan Semiconductor will not bear the consequences caused by the application of products in these fields. All problems, responsibilities and losses arising from the user's use beyond the applicable area of the product shall be borne by the user and have nothing to do with Huaguan Semiconductor, and the user shall not claim any compensation liability against Huaguan Semiconductor by the terms of this Agreement.

The technical and reliability data (including data sheets), design resources (including reference designs), application or other design suggestions, network tools, safety information and other resources provided for the performance of semiconductor products produced by Huaguan Semiconductor are not guaranteed to be free from defects and no warranty, express or implied, is made. The use of testing and other quality control technologies is limited to the quality assurance scope of Huaguan Semiconductor. Not all parameters of each device need to be tested.

The documentation of Huaguan Semiconductor authorizes you to use these resources only for developing the application of the product described in this document. You have no right to use any other Huaguan Semiconductor intellectual property rights or any third party intellectual property rights. It is strictly forbidden to make other copies or displays of these resources. You should fully compensate Huaguan Semiconductor and its agents for any claims, damages, costs, losses and debts caused by the use of these resources. Huaguan Semiconductor accepts no liability for any loss or damage caused by infringement.

X-ON Electronics

Largest Supplier of Electrical and Electronic Components

Click to view similar products for [Linear Voltage Regulators](#) category:

Click to view products by [HGSEMI](#) manufacturer:

Other Similar products are found below :

[LV5684PVD-XH](#) [MCDTSA6-2R](#) [L7815ACV-DG](#) [714954EB](#) [ZMR500QFTA](#) [BA033LBSG2-TR](#) [LV5680P-E](#) [L79M05T-E](#) [L78LR05D-MA-E](#) [NCV317MBTG](#) [NTE7227](#) [MP2018GZD-33-P](#) [MP2018GZD-5-P](#) [LV5680NPVC-XH](#) [LT1054CN8](#) [UA78L09CLP](#) [UA78L09CLPR](#) [CAT6221-PPTD-GT3](#) [MC78M09CDTRK](#) [NCV51190MNTAG](#) [78M05](#) [HT7150-1](#) [UM1540DB-18](#) [XC6234H281VR-G](#) [WL2834CA-6/TR](#) [TPL730F33-5TR](#) [TLS850F1TA](#) [V50](#) [TPS549B22RVFR](#) [UM1540DB-33](#) [WL9200P3-50B](#) [WL9100P3-33B](#) [XC6219B152MR](#) [WL2855K33-3/TR](#) [PJ54BM33SE](#) [PJ9500M25SA](#) [MD7218E33PC1](#) [H7533-2PR](#) [SK7812AU](#) [SD1A30](#) [78L33](#) [TP78L33T3](#) [SK6513ST3A-50](#) [SK6054D4-09](#) [SK6054D4-18](#) [SK6054D4-11](#) [SK6054D4-10](#) [LM79L12F](#) [HLP2985AIM5X-5.0](#) [HLP2992AIM5X-5.0/NOPB](#) [HMIC5205-5.0YM5-TR](#)