

High Voltage, High Current Darlington Transistor Arrays

The seven NPN Darlington connected transistors in these arrays are well suited for driving lamps, relays, or printer hammers in a variety of industrial and consumer applications. Their high breakdown voltage and internal suppression diodes insure freedom from problems associated with inductive loads. Peak inrush currents to 500 mA permit them to drive incandescent lamps.

The MC1413, B with a 2.7 kΩ series input resistor is well suited for systems utilizing a 5.0 V TTL or CMOS Logic.

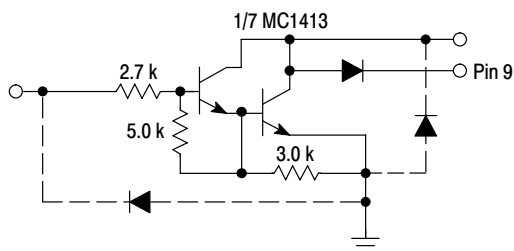
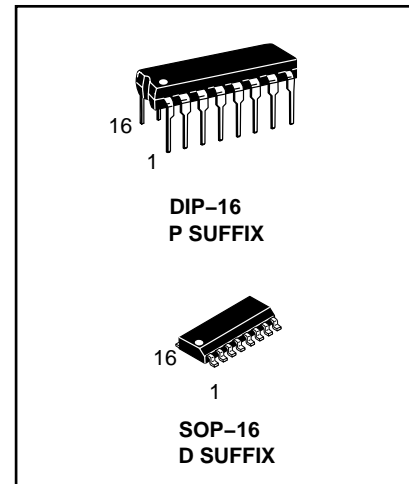

Figure 1. Representative Schematic Diagram

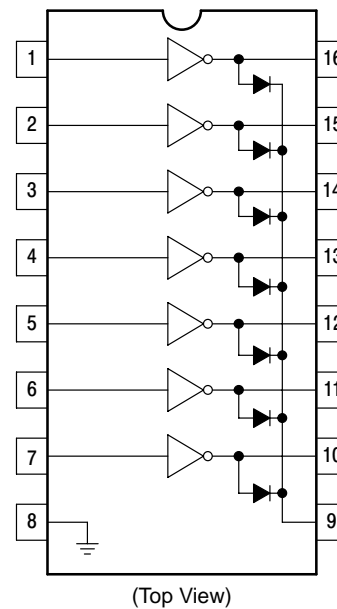

Figure 2. PIN CONNECTIONS

MAXIMUM RATINGS ($T_A = 25^\circ\text{C}$, and rating apply to any one device in the package, unless otherwise noted.)

Rating	Symbol	Value	Unit
Output Voltage	V_O	50	V
Input Voltage	V_I	30	V
Collector Current – Continuous	I_C	500	mA
Base Current – Continuous	I_B	25	mA
Operating Ambient Temperature Range MC1413 MC1413B	T_A	-20 to +85 -40 to +85	$^\circ\text{C}$
Storage Temperature Range	T_{stg}	-55 to +150	$^\circ\text{C}$
Junction Temperature	T_J	150	$^\circ\text{C}$
Thermal Resistance, Junction-to-Ambient P Suffix D Suffix	$R_{\theta JA}$	67 100	$^\circ\text{C/W}$
Thermal Resistance, Junction-to-Case P Suffix D Suffix	$R_{\theta JC}$	22 20	$^\circ\text{C/W}$
Electrostatic Discharge Sensitivity (ESD) Human Body Model (HBM) Machine Model (MM) Charged Device Model (CDM)	ESD	2000 400 1500	V

Stresses exceeding Maximum Ratings may damage the device. Maximum Ratings are stress ratings only. Functional operation above the Recommended Operating Conditions is not implied. Extended exposure to stresses above the Recommended Operating Conditions may affect device reliability.

ELECTRICAL CHARACTERISTICS ($T_A = 25^\circ\text{C}$, unless otherwise noted)

Characteristic	Symbol	Min	Typ	Max	Unit
Output Leakage Current ($V_O = 50\text{ V}$, $T_A = +85^\circ\text{C}$) ($V_O = 50\text{ V}$, $T_A = +25^\circ\text{C}$)	I_{CEX}	– –	– –	100 50	μA
Collector–Emitter Saturation Voltage ($I_C = 350\text{ mA}$, $I_B = 500\ \mu\text{A}$) ($I_C = 200\text{ mA}$, $I_B = 350\ \mu\text{A}$) ($I_C = 100\text{ mA}$, $I_B = 250\ \mu\text{A}$)	$V_{CE(sat)}$	– – –	1.1 0.95 0.85	1.6 1.3 1.1	V
Input Current – On Condition ($V_I = 3.85\text{ V}$)	$I_{I(on)}$	–	0.93	1.35	mA
Input Voltage – On Condition ($V_{CE} = 2.0\text{ V}$, $I_C = 200\text{ mA}$) ($V_{CE} = 2.0\text{ V}$, $I_C = 250\text{ mA}$) ($V_{CE} = 2.0\text{ V}$, $I_C = 300\text{ mA}$)	$V_{I(on)}$	– – –	– – –	2.4 2.7 3.0	V
Input Current – Off Condition ($I_C = 500\ \mu\text{A}$, $T_A = 85^\circ\text{C}$)	$I_{I(off)}$	50	100	–	μA
DC Current Gain ($V_{CE} = 2.0\text{ V}$, $I_C = 350\text{ mA}$)	h_{FE}	1000	–	–	–
Input Capacitance	C_I	–	15	30	pF
Turn–On Delay Time (50% E_I to 50% E_O)	t_{on}	–	0.25	1.0	μs
Turn–Off Delay Time (50% E_I to 50% E_O)	t_{off}	–	0.25	1.0	μs
Clamp Diode Leakage Current ($V_R = 50\text{ V}$)	I_R	– –	– –	50 100	μA
Clamp Diode Forward Voltage ($I_F = 350\text{ mA}$)	V_F	–	1.5	2.0	V

TYPICAL PERFORMANCE CURVES - $T_A = 25^\circ\text{C}$

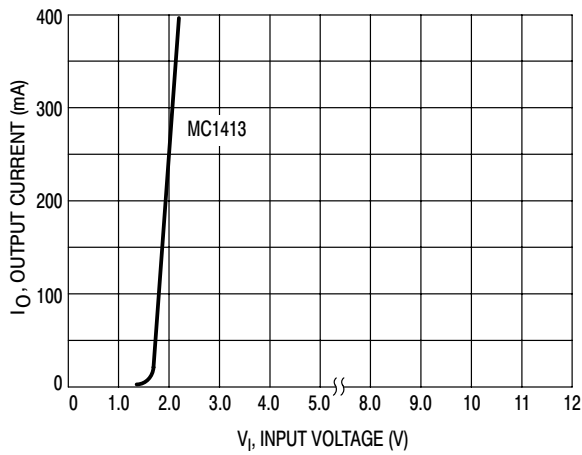

Figure 3. Output Current versus Input Voltage

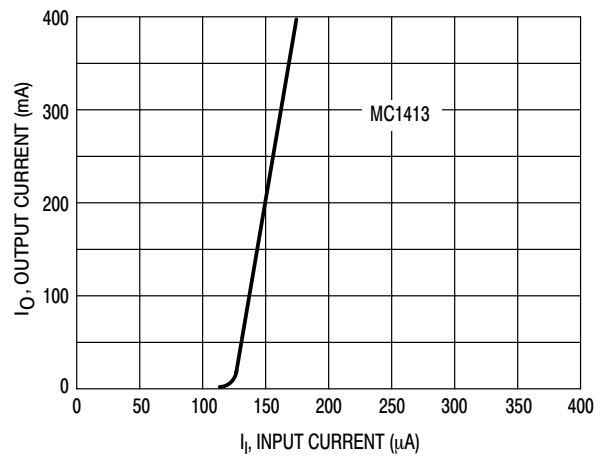

Figure 4. Output Current versus Input Current

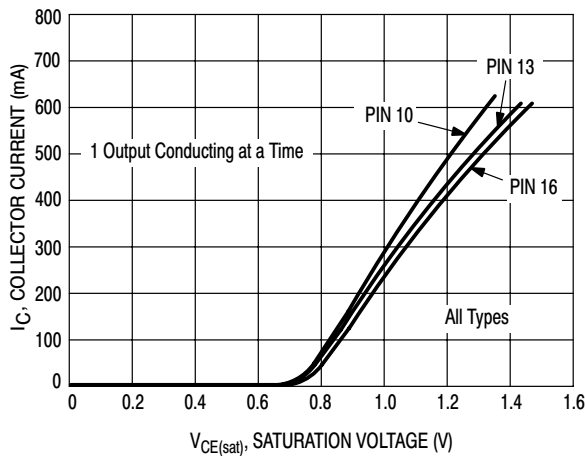

Figure 5. Typical Output Characteristics

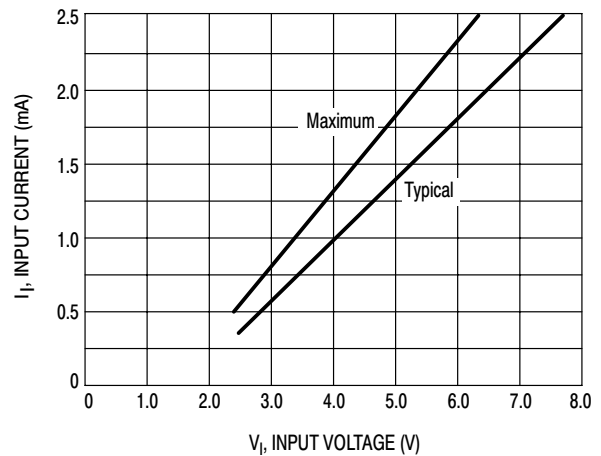

Figure 6. Input Characteristics

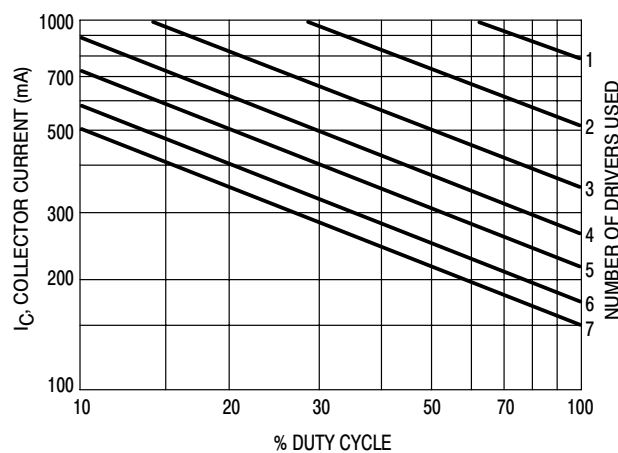

Figure 7. Maximum Collector Current versus Duty Cycle (and Number of Drivers in Use)

Important statement:

Huaguan Semiconductor Co,Ltd. reserves the right to change the products and services provided without notice. Customers should obtain the latest relevant information before ordering, and verify the timeliness and accuracy of this information.

Customers are responsible for complying with safety standards and taking safety measures when using our products for system design and machine manufacturing to avoid potential risks that may result in personal injury or property damage.

Our products are not licensed for applications in life support, military, aerospace, etc., so we do not bear the consequences of the application of these products in these fields.

Our documentation is only permitted to be copied without any tampering with the content, so we do not accept any responsibility or liability for the altered documents.

X-ON Electronics

Largest Supplier of Electrical and Electronic Components

Click to view similar products for [Darlington Transistors](#) category:

Click to view products by [HGSEMI](#) manufacturer:

Other Similar products are found below :

[281287X](#) [SMMBT6427LT1G](#) [2N7371](#) [BDV64B](#) [JANTXV2N6287](#) [028710A](#) [SMMBTA64LT1G](#) [2N6350](#) [2SB1214-TL-E](#)
[SMMBTA14LT1G](#) [SBSP52T1G](#) [NJVMJD117T4G](#) [Jantx2N6058](#) [2N6353](#) [LB1205-L-E](#) [500-00005](#) [2N6053](#) [NJVMJD112G](#) [Jan2N6350](#)
[Jantx2N6352](#) [Jantx2N6350](#) [BULN2803LVS](#) [ULN2001N](#) [2SB1383](#) [2SB1560](#) [2SB852KT146B](#) [TIP112TU](#) [TIP122TU](#) [BCV27](#) [MMBTA13-](#)
[TP](#) [MMBTA14-TP](#) [MMSTA28T146](#) [BSP50H6327XTSA1](#) [KSH122TF](#) [NTE2557](#) [NJVNJD35N04T4G](#) [TIP115](#) [MPSA29-D26Z](#) [MJD127T4](#)
[FJB102TM](#) [BCV26E6327HTSA1](#) [BCV46E6327HTSA1](#) [BCV47E6327HTSA1](#) [BSP61H6327XTSA1](#) [BU941ZPFI](#) [2SB1316TL](#) [2SD1980TL](#)
[NTE2350](#) [NTE245](#) [NTE246](#)