

## SOT-23 Plastic-Encapsulate Diodes

### SCHOTTKY BARRIER DIODE

#### Features

- Extremely Fast Switching Speed

#### Marking:

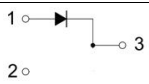
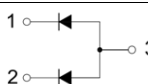
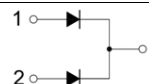
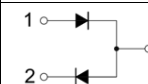
BAT54	BAT54A	BAT54C	BAT54S
			
MARKING: KL1	MARKING: KL2	MARKING: KL3	MARKING: KL4

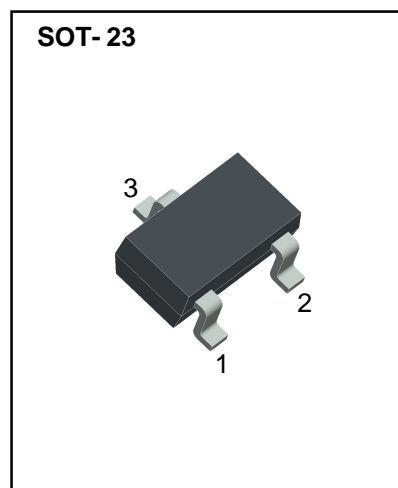

#### Limiting Values( Absolute Maximum Rating)

Parameter	Symbol	Value	Unit
Peak Repetitive Reverse Voltage	$V_{RRM}$	30	V
Working Peak Reverse Voltage	$V_{RWM}$		
DC Blocking Voltage	$V_R$		
Forward Continuous Current	$I_{FM}$	200	mA
Non-repetitive Peak Forward Surge Current @ $t=8.3ms$	$I_{FSM}$	600	mA
Repetitive Peak Forward Current @ $t \leq 1s, \delta \leq 0.5$	$I_{FRM}$	300	mA
Power Dissipation	$P_D$	200	mW
Thermal Resistance from Junction to Ambient	$R_{\theta JA}$	500	$^{\circ}C/W$
Junction Temperature	$T_j$	125	$^{\circ}C$
Storage Temperature	$T_{stg}$	-55~+150	$^{\circ}C$

#### Electrical Characteristics (Ta=25 $^{\circ}C$ Unless otherwise specified)

Parameter	Symbol	Min	Typ	Max	Unit	Test conditions
Reverse voltage	$V_{(BR)}$	30			V	$I_R=100\mu A$
Forward voltage	$V_F$			0.24	V	$I_{F1}=0.1mA$
				0.32	V	$I_{F2}=1mA$
				0.40	V	$I_{F3}=10mA$
				0.50	V	$I_{F4}=30mA$
				1	V	$I_{F5}=100mA$
Reverse current	$I_R$			2	$\mu A$	$V_R=25V$
Diode capacitance	$C_D$			10	pF	$V_R=1V, f=1MHz$
Reverse recovery time	$t_{rr}$			5	ns	$I_F=I_R=10mA$ $I_{rr}=0.1 \times I_R, R_L=100\Omega$

# Typical Characteristics

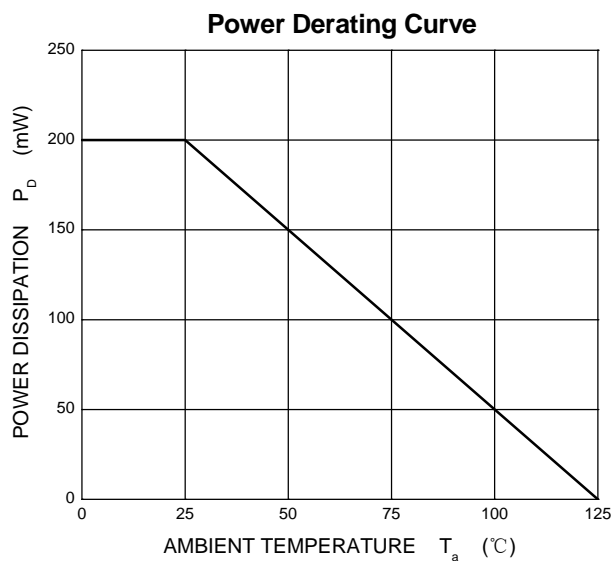
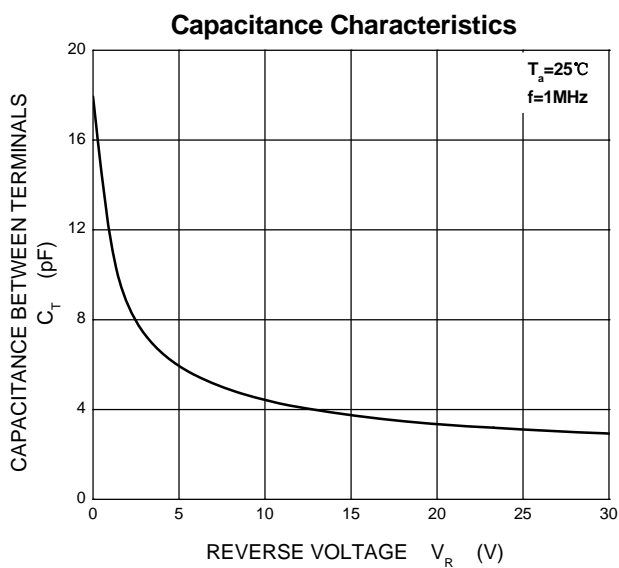
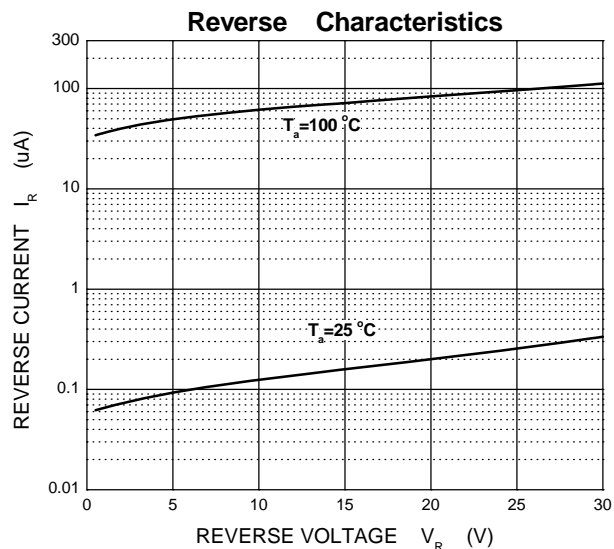
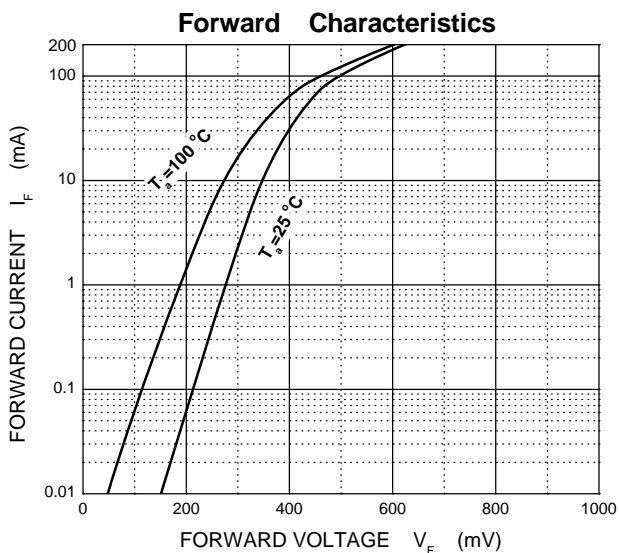

## SOT-23 Package Outline Dimensions

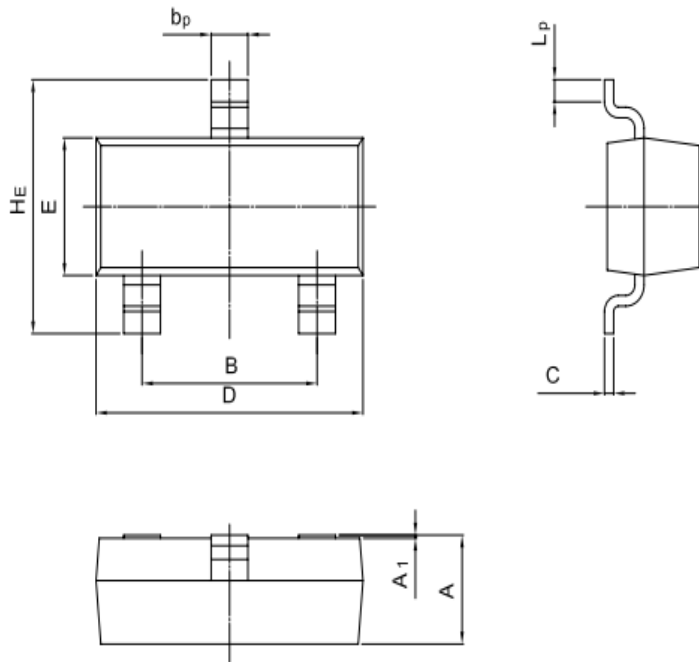

UNIT	A	B	bp	C	D	E	HE	A1	Lp
mm	1.40 0.95	2.04 1.78	0.50 0.35	0.19 0.08	3.10 2.70	1.65 1.20	3.00 2.20	0.100 0.013	0.50 0.20

## SOT-23 Suggested Pad Layout

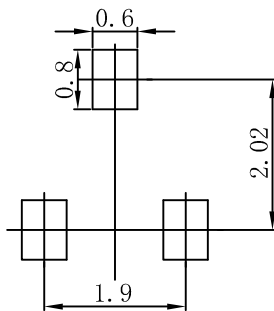

### Note:

1. Controlling dimension: in millimeters.
2. General tolerance:  $\pm 0.05$  mm.
3. The pad layout is for reference purposes only.

### NOTICE

JSHD reserve the right to make modifications, enhancements, improvements, corrections or other changes without further notice to any product herein. JSHD does not assume any liability arising out of the application or use of any product described herein.

# Reel Taping Specifications For Surface Mount Devices-SOT-23

## SOT-23 Embossed Carrier Tape

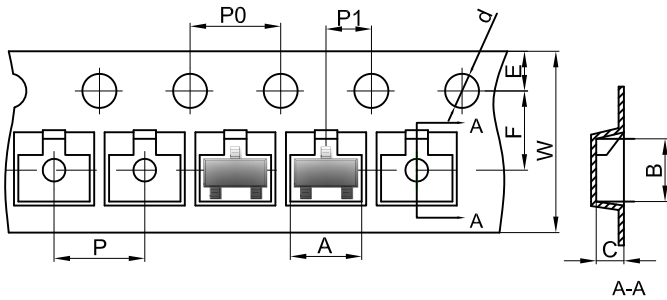

### Packaging Description:

SOT-23 parts are shipped in tape. The carrier tape is made from a dissipative (carbon filled) polycarbonate resin. The cover tape is a multilayer film (Heat Activated Adhesive in nature) primarily composed of polyester film, adhesive layer, sealant, and anti-static sprayed agent. These reeled parts in standard option are shipped with 3,000 units per 7" or 17.8cm diameter reel. The reels are clear in color and is made of polystyrene plastic (anti-static coated).

Dimensions are in millimeter

Pkg type	A	B	C	d	E	F	P0	P	P1	W
SOT-23	3.15	2.77	1.22	Ø1.50	1.75	3.50	4.00	4.00	2.00	8.00

## SOT-23 Tape Leader and Trailer

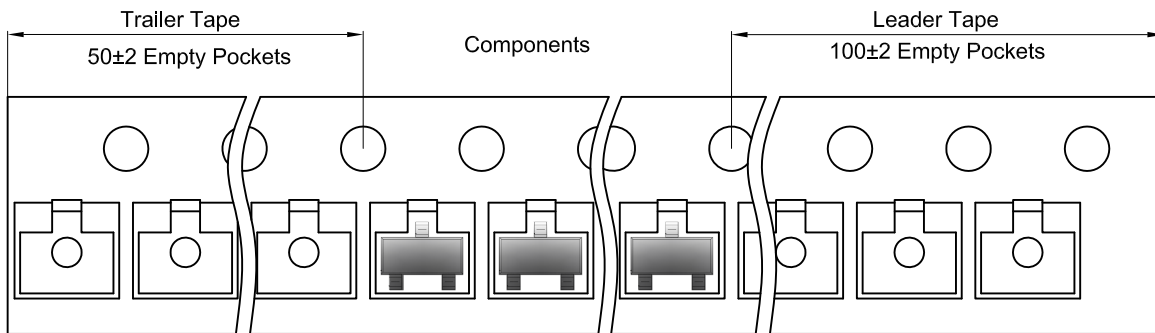

## SOT-23 Reel

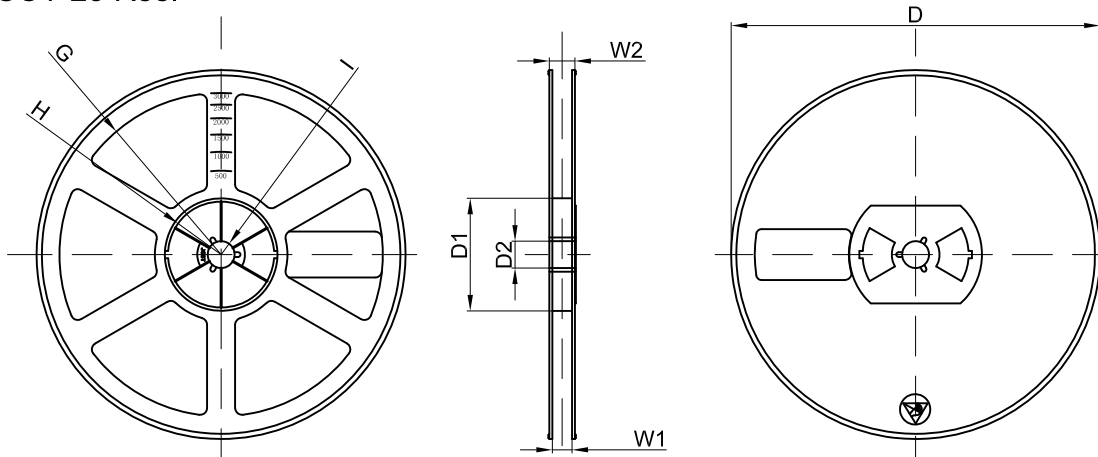

Dimensions are in millimeter

Reel Option	D	D1	D2	G	H	I	W1	W2
7"Dia	Ø178.00	54.40	13.00	R78.00	R25.60	R6.50	9.50	12.30

REEL	Reel Size	Box	Box Size(mm)	Carton	Carton Size(mm)	G.W.(kg)
3000 pcs	7 inch	45,000 pcs	203×203×195	180,000 pcs	438×438×230	

## X-ON Electronics

Largest Supplier of Electrical and Electronic Components

*Click to view similar products for [Schottky Diodes & Rectifiers](#) category:*

*Click to view products by [High Diode](#) manufacturer:*

Other Similar products are found below :

[CUS06\(TE85L,Q,M\)](#) [MA4E2039](#) [D1FH3-5063](#) [MBR0530L-TP](#) [MBR10100CT-BP](#) [MBR30H100MFST1G](#) [MMBD301M3T5G](#) [PMAD1103-LF](#) [PMAD1108-LF](#) [RB160M-50TR](#) [RB520S-30](#) [RB551V-30](#) [DD350N18K](#) [DZ435N40K](#) [DZ600N16K](#) [BAS16E6433HTMA1](#) [BAS 3010S-02LRH E6327](#) [BAT 54-02LRH E6327](#) [IDL02G65C5XUMA1](#) [NSR05F40QNXT5G](#) [NSVR05F40NXT5G](#) [JANS1N6640](#) [SB07-03C-TB-H](#) [SB1003M3-TL-W](#) [SBAT54CWT1G](#) [SBM30-03-TR-E](#) [SBS818-TL-E](#) [SK32A-LTP](#) [SK33A-TP](#) [SK34A-TP](#) [SK34B-TP](#) [SMD1200PL-TP](#) [ACDBN160-HF](#) [SS3003CH-TL-E](#) [STPS30S45CW](#) [PDS3100Q-7](#) [GA01SHT18](#) [CRS10I30A\(TE85L,QM\)](#) [MBR1240MFST1G](#) [MBRB30H30CT-1G](#) [BAS28E6433HTMA1](#) [BAS 70-02L E6327](#) [HSB123JTR-E](#) [JANTX1N5712-1](#) [VS-STPS40L45CW-N3](#) [DD350N12K](#) [SB007-03C-TB-E](#) [SB10015M-TL-E](#) [SB1003M3-TL-E](#) [SK110-LTP](#)