

SMAG Plastic-Encapsulate Diodes

Super Fast Recovery Rectifier Diode

Features

- I_o 1A
- V_{RRM} 50V-600V
- High surge current capability
- Glass passivated chip
- Polarity: Color band denotes cathode

Applications

- Rectifier

Marking

- ES1X
- X : From A To J

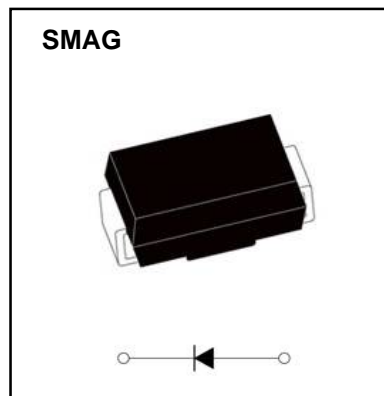

Limiting Values (Absolute Maximum Rating)

Item	Symbol	Unit	Test Conditions	ES1							
				A	B	C	D	E	G	H	J
Repetitive Peak Reverse Voltage	V_{RRM}	V		50	100	150	200	300	400	500	600
Maximum RMS Voltage	V_{RMS}	V		35	70	105	140	210	280	350	420
Average Forward Current	$I_{F(AV)}$	A	60HZ Half-sine wave, Resistance load, $T_L=120^\circ\text{C}$	1.0							
Surge(Non-repetitive)Forward Current	I_{FSM}	A	60Hz Half-sine wave ,1 cycle , $T_a=25^\circ\text{C}$	30							
Junction Temperature	T_J	$^\circ\text{C}$		-55~+150							
Storage Temperature	T_{STG}	$^\circ\text{C}$		-55 ~ +150							

Electrical Characteristics (T=25°C Unless otherwise specified)

Item	Symbol	Unit	Test Condition	ES1								
				A	B	C	D	E	G	H	J	
Peak Forward Voltage	V_F	V	$I_F=1.0A$	0.95				1.25		1.70		
Maximum reverse recovery time	t_{rr}	ns	$I_F=0.5A, I_R=1.0A, I_{rr}=0.25A$	35								
Peak Reverse Current	I_{RRM1}	μA	$V_{RM}=V_{RRM}$	$T_a=25^\circ\text{C}$								
	I			$T_a=100^\circ\text{C}$								
Thermal Resistance(Typical)	$R_{\theta J-A}$	$^\circ\text{C/W}$	Between junction and ambient		85 ¹⁾							
	$R_{\theta J-L}$		Between junction and terminal		35 ¹⁾							

Notes:

Thermal resistance from junction to ambient and from junction to lead mounted on P.C.B. with 0.2" x 0.2" (5.0 mm x 5.0 mm) copper pad areas

Typical Characteristics

FIG.1: FORWARD CURRENT DERATING CURVE

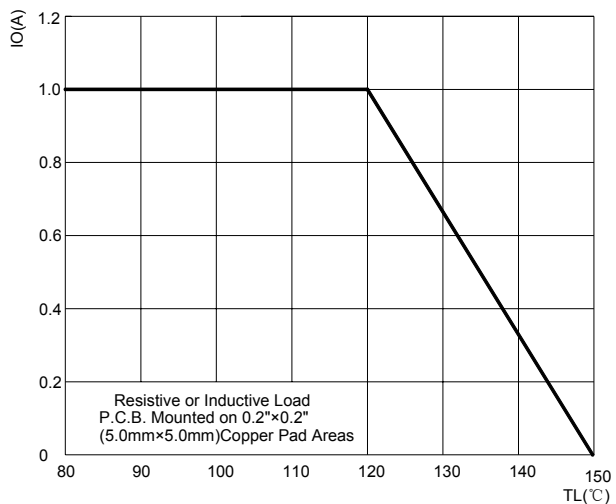

FIG.2: MAXIMUM NON-REPETITIVE FORWARD URGE CURRENT

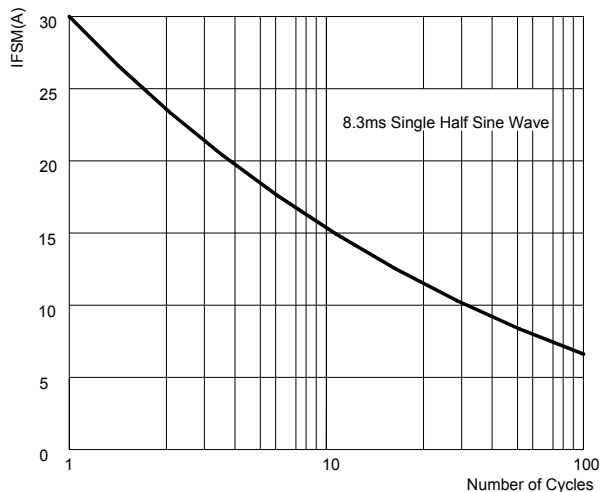

FIG.3: TYPICAL FORWARD CHARACTERISTICS

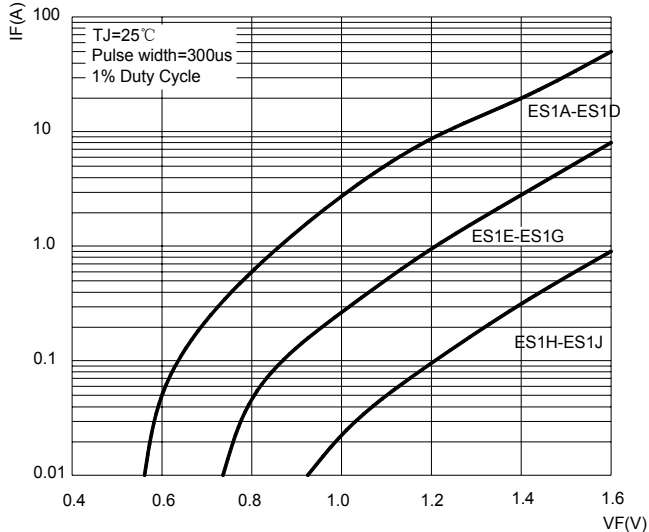

FIG.4: TYPICAL REVERSE CHARACTERISTICS

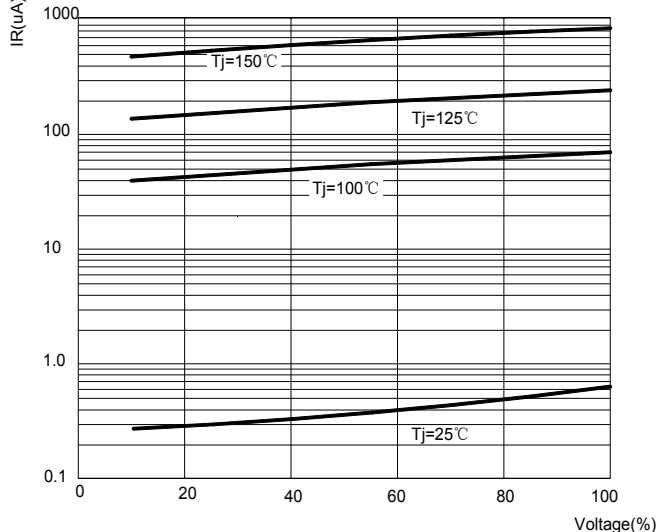
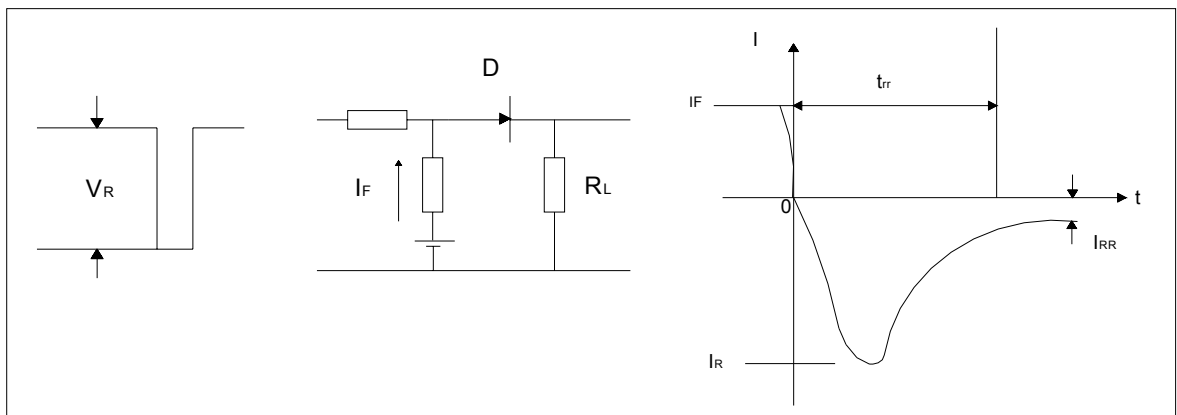
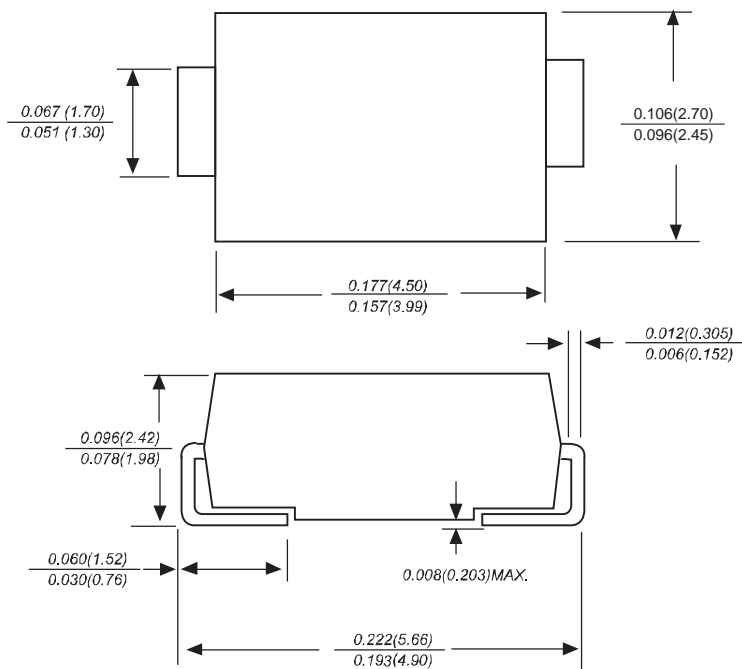

FIG.5: Diagram of circuit and Testing wave form of reverse recovery time



SMAG Package Outline Dimensions



Dimensions in inches and (millimeters)

SMAG Suggested Pad Layout

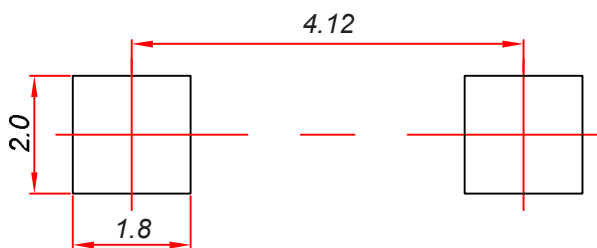

Note:

1. Controlling dimension: in millimeters.
2. General tolerance: ± 0.05 mm.
3. The pad layout is for reference purposes only.

NOTICE

JSHD reserve the right to make modifications, enhancements, improvements, corrections or other changes without further notice to any product herein. JSHD does not assume any liability arising out of the application or use of any product described herein.

Reel Taping Specifications For Surface Mount Devices- SMAG

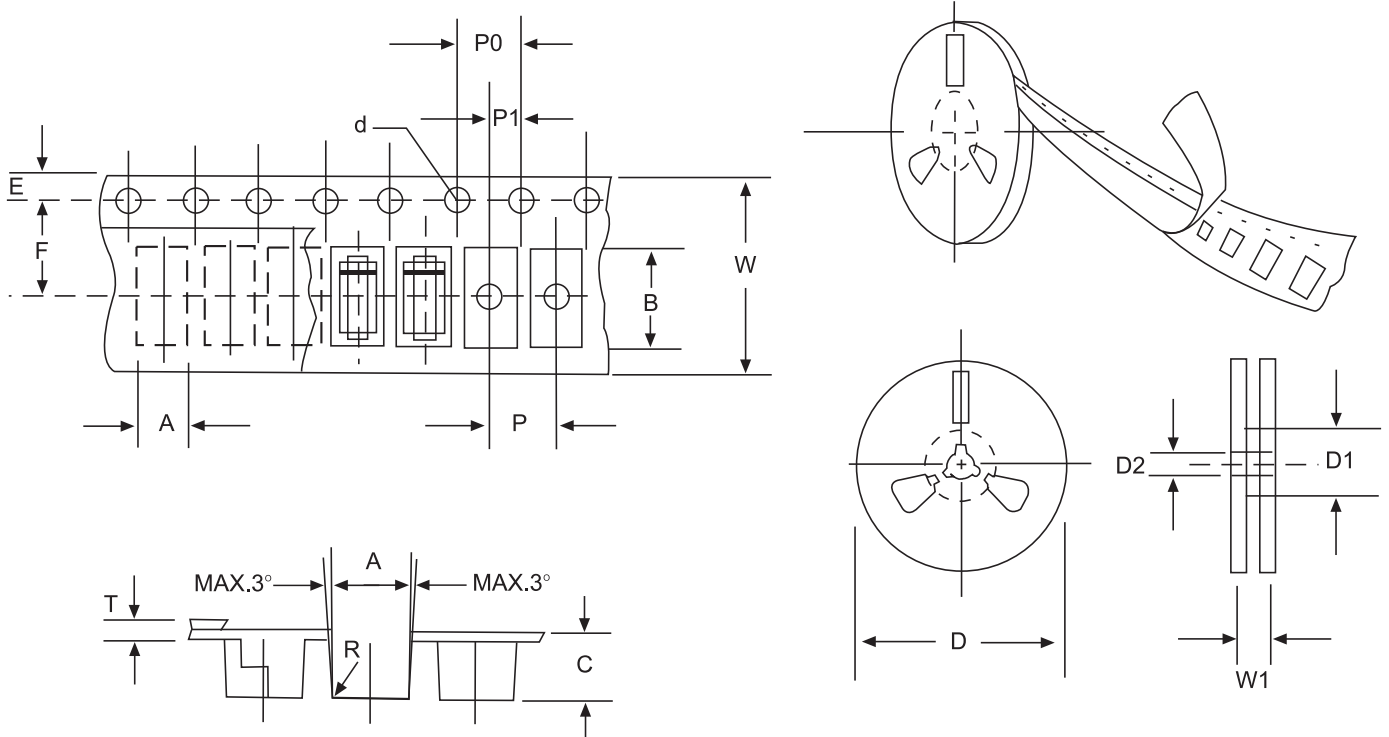

Fig:CONFIGURATION OF FLAT MELF TAPING

ITEM	SYMBOL	SMAG mm(inch)
Carrier width	A	2.79±0.1(0.110±0.004)
Carrier length	B	5.33±0.1(0.210±0.004)
Carrier depth	C	2.36±0.1(0.093±0.004)
Sprocket hole	d	1.5±0.05(0.059±0.0002)
Reel outside diameter	D	330/178±2.0(13/7.0±0.79)
Reel inner diameter	D1	75/54 ±1.0 (2.95/2.13 ±0.039)
Feed hole diameter	D2	13±0.5(0.512±0.020)
Sprocket hole position	E	1.75±0.1(0.069±0.004)
Punch hole position	F	5.5±0.05(0.217±0.002)
Punch hole pitch	P	4.0±0.1(0.157±0.004)
Sprocket hole pitch	P0	4.0±0.1(0.157±0.004)
Embossment center	P1	2.0±0.1(0.079±0.004)
Total tape thickness	T	0.28±0.02(0.011 ±0.0008)
Tape width	W	12.0±0.2(0.472±0.008)
Reel width	W1	16.8±2.0(0.661±0.079)

NOTE: Devices are packed in accordance with EIA standard RS-481-A and specification given above.

X-ON Electronics

Largest Supplier of Electrical and Electronic Components

Click to view similar products for [Rectifiers](#) category:

Click to view products by [High Diode](#) manufacturer:

Other Similar products are found below :

[D91A](#) [DA24F4100L](#) [DD89N1600K-A](#) [DD89N16K-K](#) [RL252-TP](#) [DLA11C-TR-E](#) [DSA17G](#) [1N4005-TR](#) [BAV199-TP](#) [UFS120Je3/TR13](#)
[JANS1N6640US](#) [VS-80-1293](#) [DD89N16K](#) [DD89N16K-A](#) [481235F](#) [DSP10G-TR-E](#) [067907F](#) [MS306](#) [ND104N08K](#) [SPA2003-B-D-A01](#) [VS-](#)
[80-6193](#) [VS-66-9903](#) [VGF0136AB](#) [US2JFL-TP](#) [UFS105Je3/TR13](#) [A1N5404G-G](#) [ACGRA4007-HF](#) [ACGRB207-HF](#) [RF301B2STL](#)
[RF501B2STL](#) [UES1306](#) [UES1302](#) [BAV199E6433HTMA1](#) [ACGRC307-HF](#) [ACEFC304-HF](#) [JANTXV1N5660A](#) [UES1106](#) [GS2K-LTP](#)
[D126A45C](#) [D251N08B](#) [SCHJ22.5K](#) [SM100](#) [SCPA2](#) [SCH10000](#) [SDHD5K](#) [STTH20P035FP](#) [VS-8EWS12S-M3](#) [VS-12FL100S10](#)
[ACGRA4001-HF](#) [MUR420GP-TP](#)