

## » Features

- Snap-in type, can be mounted directly on P.C.B Board.
- Parts of output terminals can be used as jumper lead, facilitating circuit design.
- Many LED lights are available.

## » Applications

- Operating switches in all types of electronic equipment such as audio apparatus, office equipment, communications apparatus, TV sets, VCRs, etc.

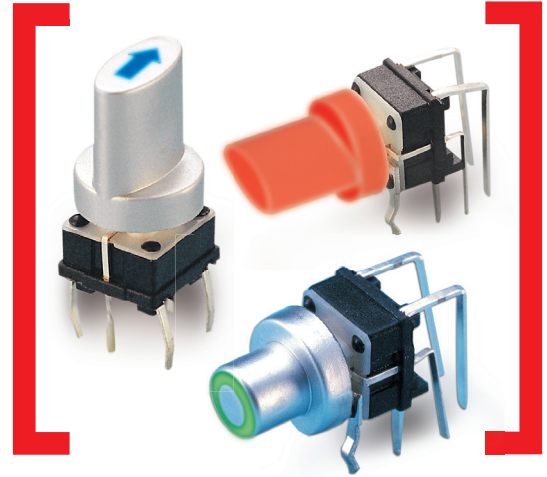

## » Specifications

Rating	50mA 12VDC
Insulation Resistance	100MΩ Min (at 250 VDC)
Dielectric Strength	AC 250V (50/60 Hz for 1 minute)
Contact Resistance	100mΩ Max. (Initial)
Electrically Life	300,000 Cycles Min
Ambient Temperature	-25°C~ +70°C
Operating Force	160 ± 50gf

## » Product selection

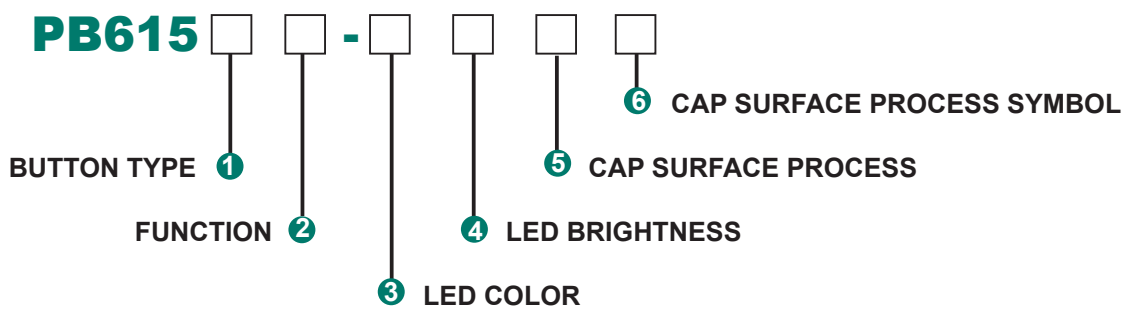

### ① BUTTON TYPE



## 2 FUNCTION

Non-illuminated		Illuminated	
_	Standard Type (2P)	L	Standard Type (2P)
H	Standard Type (4P)	HL	Standard Type (4P)
M	SMT Type (2P)	ML	SMT Type (2P)
HM	SMT Type (4P)	HML	SMT Type (4P)
R	Right Angle	RL	Right Angle
RS	Right Angle (+Fix)	RSL	Right Angle (+Fix)

## 3 LED COLOR

1	Red
2	Yellow
3	Green
4	Blue
5	White
6	Pure Green
12	Red / Yellow
13	Red / Green
23	Yellow/ Green
164	Red / Pure Green / Blue

## 4 LED BRIGHTNESS

_	Standard
C	Customization

## 5 CAP SURFACE PROCESS

1	Misty Silver
2	Bright Silver
3	Gold

## 6 CAP SURFACE PROCESS SYMBOL

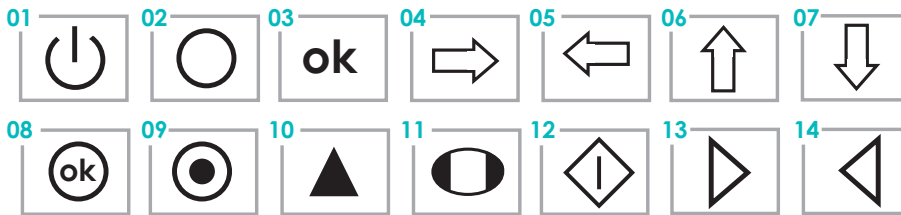

## » LED Specifications

Color	VR	IF	Recommended Operating Current	VF	
				Nom	Max
Red	DC 5V	20mA	20mA	1.7V	2.4V
Green	DC 5V	20mA	20mA	1.9V	2.4V
Yellow	DC 5V	20mA	20mA	1.9V	2.4V
Blue	DC 5V	20mA	20mA	3.0V	3.6V
White	DC 5V	20mA	20mA	3.0V	3.6V

## » Operating characteristics

Unit: mm

Dimensions

Circuit P.C.B Layout

### PB6151L-□-104

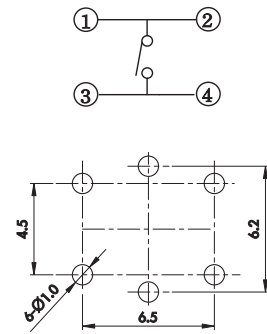
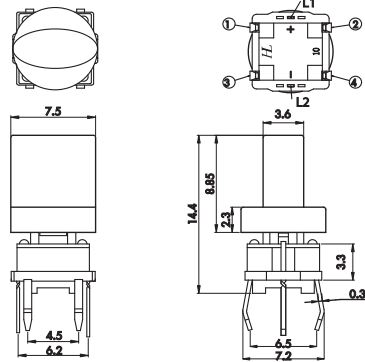
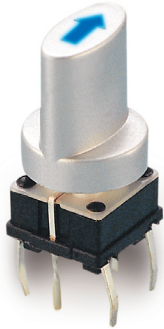

### PB6152RSL

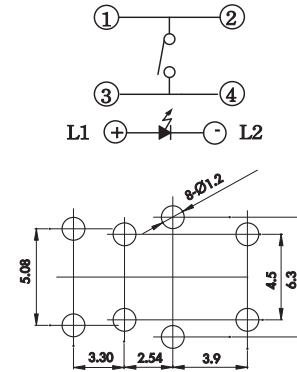
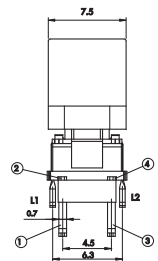
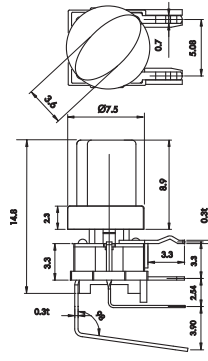
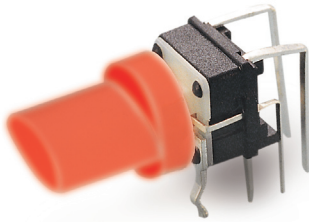

### PB6156RSL-□-102

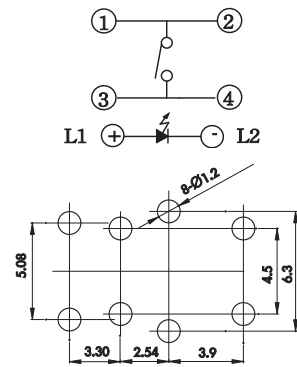
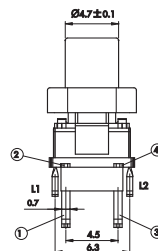
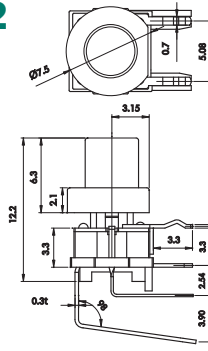
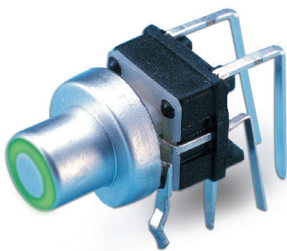

## X-ON Electronics

Largest Supplier of Electrical and Electronic Components

*Click to view similar products for [Input Devices](#) category:*

*Click to view products by [Highly manufacturer](#):*

Other Similar products are found below :

[80260-08](#) [M11L0A1](#) [M11L0B1M](#) [M21L0H1PX](#) [M41C091P100](#) [80260-00](#) [81521-08](#) [FKB4720-103](#) [84250-26](#) [84980-04](#) [84S-AC1-000](#)  
[C10O0C1P](#) [JD-0700EU-2](#) [JM-0800-2](#) [JOY-THUMB](#) [JW-T0100](#) [89498-13](#) [89758-05](#) [89886-26](#) [89941-00](#) [FQ-XT](#) [G3-A1AM151NNNN](#)  
[G80-3000LSCEU-2](#) [M11C011B](#) [TH500P00D4](#) [MJ0FGGRY](#) [JM-0800-0](#) [KBCV-4100W](#) [MR2110R5BB](#) [60C22-M7-4-020S](#) [67A-DF-3C-](#)  
[060C](#) [84S-BB1-004](#) [81601-26](#) [G8011900LPMUS0](#) [G844420LUBEU0](#) [G84-4700LUCUS-0](#) [89701-26](#) [81485-26](#) [84105-13](#) [V400-W24 5M](#)  
[V400-W23 5M](#) [G84-5200LCMEU-2](#) [M11F061P](#) [84Z2029-100](#) [4P182F1D0100](#) [M41L091M](#) [M41L091P](#) [60A00-8-050C](#) [84Z2029-78](#)  
[XD2CF1111](#)