

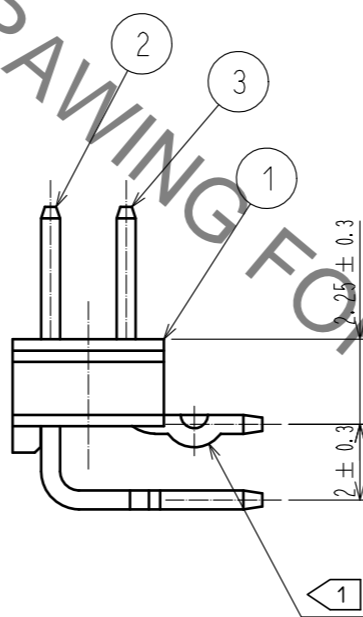

Jul.1.2021 Copyright 2021 HIROSE ELECTRIC CO., LTD. All Rights Reserved.
 In case of consideration for using Automotive equipment / device which demand high reliability, kindly contact our sales window correspondents.

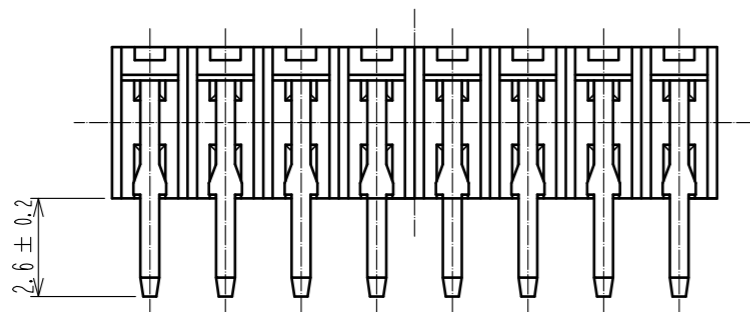

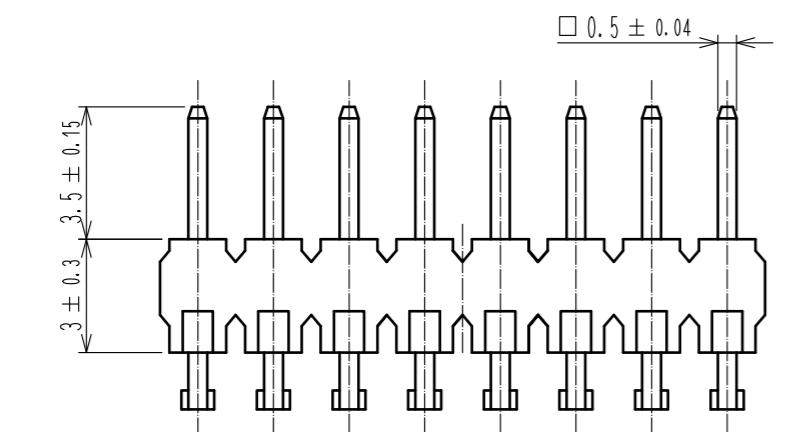

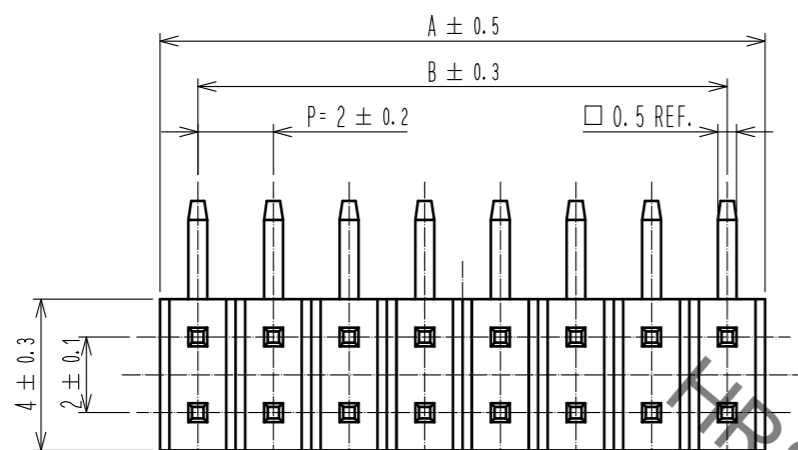
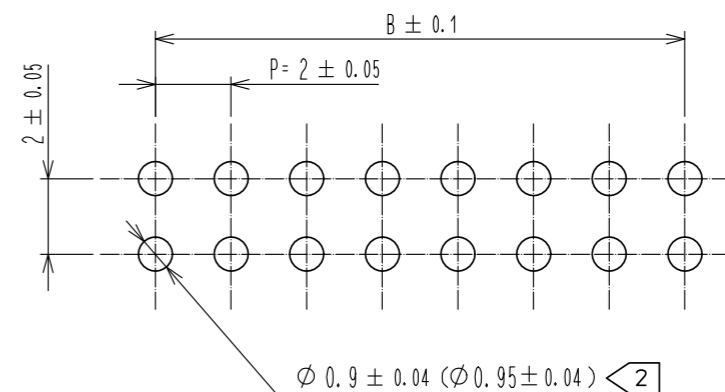



RECOMMENDED PC BOARD HOLE PATTERN

(PCB THICKNESS : t=1.6)



PART NO.	CODE NO.	PIN	A	B	KINKED POSITION 
A3B- 4PA-2DS(51)	CL621-0351-5-51	4	4	2	2PINS
A3B- 6PA-2DS(51)	CL621-0352-8-51	6	6	4	1 OR 2 PINS ON EVERY OTHER PINS
A3B- 8PA-2DS(51)	CL621-0353-0-51	8	8	6	2 PINS ON EVERY OTHER PINS
A3B-10PA-2DS(51)	CL621-0354-3-51	10	10	8	2 OR 3 PINS ON EVERY OTHER PINS
A3B-12PA-2DS(51)	CL621-0355-6-51	12	12	10	3 PINS ON EVERY OTHER PINS
A3B-14PA-2DS(51)	CL621-0356-9-51	14	14	12	3 OR 4 PINS ON EVERY OTHER PINS
A3B-16PA-2DS(51)	CL621-0357-1-51	16	16	14	4 PINS ON EVERY OTHER PINS
A3B-18PA-2DS(51)	CL621-0358-4-51	18	18	16	4 OR 5 PINS ON EVERY OTHER PINS
A3B-20PA-2DS(51)	CL621-0359-7-51	20	20	18	5 PINS ON EVERY OTHER PINS
A3B-22PA-2DS(51)	CL621-0360-6-51	22	22	20	5 OR 6 PINS ON EVERY OTHER PINS
A3B-24PA-2DS(51)	CL621-0361-9-51	24	24	22	6 PINS ON EVERY OTHER PINS
A3B-26PA-2DS(51)	CL621-0362-1-51	26	26	24	6 OR 7 PINS ON EVERY OTHER PINS
A3B-28PA-2DS(51)	CL621-0363-4-51	28	28	26	7 PINS ON EVERY OTHER PINS
A3B-30PA-2DS(51)	CL621-0364-7-51	30	30	28	7 OR 8 PINS ON EVERY OTHER PINS
A3B-32PA-2DS(51)	CL621-0365-0-51	32	32	30	8 PINS ON EVERY OTHER PINS
A3B-36PA-2DS(51)	CL621-0369-0-51	36	36	34	9 PINS ON EVERY OTHER PINS
A3B-40PA-2DS(51)	CL621-0373-8-51	40	40	38	10 PINS ON EVERY OTHER PINS
A3B-44PA-2DS(51)	CL621-0377-9-51	44	44	42	11 PINS ON EVERY OTHER PINS
A3B-50PA-2DS(51)	CL621-0383-1-51	50	50	48	12 OR 13 PINS ON EVERY OTHER PINS

NOTE  KINKED POSITION IS SHOW IN THE TABLE.
 THROUGH HOLE DIMENSION SHALL BE 0.95 ± 0.04 WHEN NUMBER OF POSITIONS IS MORE THAN 28.

1	POLYAMIDE	BLACK	UL94V-0	2, 3	BRASS	CONTACT AREA : GOLD FLASH DIP AREA : TIN-PLATING 2μm UNDER PLATING : NICKEL 2.5μm			
NO.	MATERIAL	FINISH	REMARKS	NO.	MATERIAL	FINISH . REMARKS			
UNITS mm			SCALE 5 : 1		COUNT	DESCRIPTION OF REVISIONS	DESIGNED	CHECKED	DATE
HRS HIROSE ELECTRIC CO., LTD.		APPROVED : NH. NAKATA	17. 04. 10	DRAWING NO.		EDC-375928-00-00			
		CHECKED : HT. YAMAGUCHI	17. 04. 10	PART NO.		A3B- * PA-2DS(51)			
		DESIGNED : HR. NAGAYASU	17. 04. 10	CODE NO.		CL621			
		DRAWN : HR. NAGAYASU	17. 04. 10						

X-ON Electronics

Largest Supplier of Electrical and Electronic Components

Click to view similar products for [Headers & Wire Housings](#) category:

Click to view products by [Hirose](#) manufacturer:

Other Similar products are found below :

[892-18-020-10-001101](#) [58102-G61-06LF](#) [582553-1](#) [0009485154](#) [009176003701906](#) [0050291907](#) [LY20-4P-DT1-P1E-BR](#) [02.125.8002.8](#)
[609-3404](#) [61062-3](#) [622-0430](#) [622-3653LF](#) [63453-116](#) [636-1030](#) [636-1427](#) [636-3427](#) [636-4007](#) [641938-9](#) [641991-4](#) [644827-2](#) [65817-010LF](#)
[65817-015LF](#) [65863-015LF](#) [66207-023LF](#) [67095-007LF](#) [67601157](#) [68648-049](#) [70.362.1628.0](#) [70-4210](#) [70-4226B](#) [70-4853B](#) [707-5020](#) [707-5028](#) [71.350.2428.0](#) [71918-208LF](#) [71961-016LF](#) [733-134](#) [733-162](#) [754199-000](#) [760-3052](#) [787-8014-00](#) [79531-3000](#) [FCN-360C032-B](#) [FCN-367T-T012/H](#) [FCN-723D010/2](#) [80.063.4001.1](#) [800-90-001-10-001000](#) [800-90-010-10-002000](#) [801-43-002-10-013000](#) [801-43-006-10-002000](#)