

## 3.3 mm Contact Pitch, Connectors for Internal Power Supplies

### DF33 Series

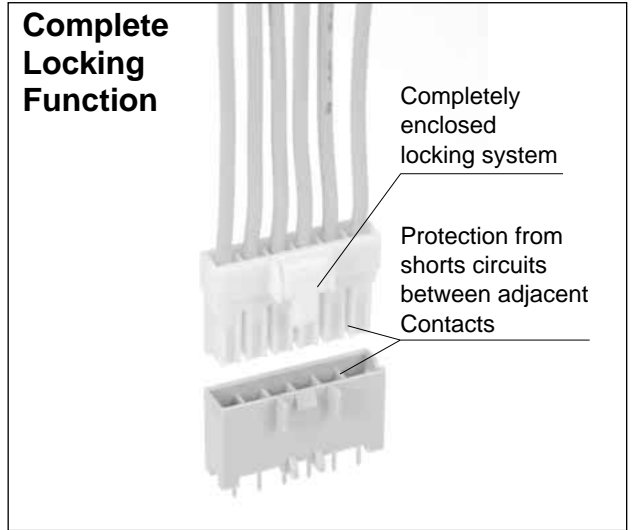
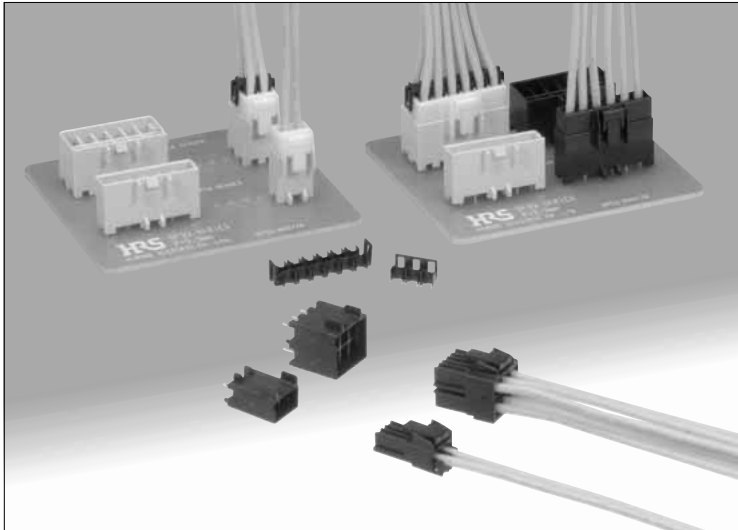

#### ■ Features

##### 1. 5 A maximum current

Single row connector can carry current of 5 A with #20 AWG conductor. Please refer to Table #1 for current ratings for multi-position connectors using other conductor sizes.

##### 2. Complete Locking Function

Reliable interior lock protects mated connectors from accidental disconnection.

##### 3. Prevention of Incorrect Connections

To prevent incorrect connection when using multiple connectors having the same Number of contacts, 3 product types having different mating configurations are available.

##### 4. Prevention of incorrect board placement

Built-in posts assure correct connector placement and orientation on the board.

##### 5. Supports encapsulation

Connectors can be encapsulated up to 10 mm without affecting the performance.

##### 6. Prevention of Short Circuits Between Adjacent Contacts

Each Contact is completely surrounded by the insulator housing electrically isolating it from adjacent contacts.

##### 7. Increased Retention Force of Crimped Contacts and confirmation of complete contact insertion

Separate contact retainers are provided for applications where extreme pull-out forces may be applied against the wire or when a visual confirmation of the full contact insertion is required.

#### Prevention of Incorrect Connections

##### ● Standard Type (Color: natural)

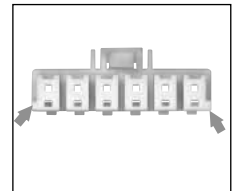
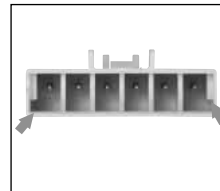

##### ● R Type (Color: black)

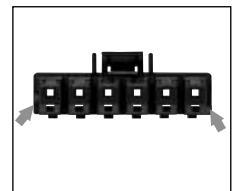
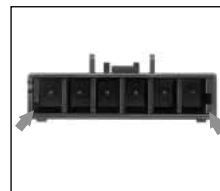

\*The photographs on the left show header (the board dip side), the photographs on the right show the socket (cable side).

\*The guide key position is indicated in position facing the mating surface of the header.

## ■ Product Specifications

Ratings	Current rating	Number of rows	Number of contacts	AWG20	AWG22	Operating temperature range	-35°C to 85°C (Note 1)
		1	2 to 6	5A	5A	Operating humidity range	40% to 80%
	2	4 to 12	5A	4A	Storage temperature range	-10°C to 60°C (Note 2)	
	Voltage rating	AC/DC 500V			Storage humidity range	40% to 70% (Note 2)	

Item	Specification	Condition
1. Contact resistance	Contact resistance(Initial value): 10 m ohms max.	20mV max., 1mA
2. Insulator resistance	1000 M ohms min.	500 V DC
3. Withstanding voltage	No flashover or Insulator breakdown	1500 V AC for 1 minute
4. Insertion-Extraction force (per contact)	0.5N min., 4.5N max.	Measured with a steel pin of 0.5 x 0.5 ± 0.002 thickness
5. Durability (mating/unmating)	Contact resistance of 20 m ohms max.	30 cycles
6. Vibration	No electrical discontinuity of 1 μs. min.	Frequency 10 to 55 Hz, single amplitude of 0.75 mm, 3 axis, duration of 2 hours
7. Shock	No electrical discontinuity of 1 μs. min.	Acceleration of 490 m/s <sup>2</sup> ; 11 ms duration, sine half-wave waveform, 3 cycles in each of the 3 axis.
8. Humidity	Contact resistance 20 m ohms max.	Temperature 40°C ± 2°C, 90% to 95% RH, 96 hours
9. Temperature cycle	Contact resistance of 20 m ohms max.	(-55°C: 30 minutes→5 to 35°C: 5 minutes→85°C: 30 minutes→5 to 35°C: 5 minutes) for 5 cycles
10. Resistance to Soldering heat	No deformation of the insulator parts affecting performance	Flow solder temperature 260°C, for 10 seconds Manual soldering: Soldering iron temperature 320°C, 3 seconds

Note 1: Includes temperature rise caused by the current flow.

Note 2: The term "storage" refers to products stored for long period of time prior to mounting and use. Operating Temperature Range and Humidity range covers non- conducting condition of installed connectors in storage, shipment or during transportation.

## ■ Materials

Product	Part	Material	Finish	Remarks
Sockets	Insulator	Polyamide	Color: Natural white (Note 1)	UL94V-0
Crimp contacts	Contacts	Copper alloy	Tin plated (Note 2)	—
Headers	Insulator	Polyamide (Glass reinforced)	Color: Natural beige (Note 1)	UL94V-0
	Contacts	Copper alloy	Tin plated (Note 2)	—
Retainer	Insulator	PBT	Color: Black	UL94V-0

Note 1: Standard Color, colors of the differing coupling forms are black for DF33R.

Note 2: Hirose Electric's plating incorporate anti-whisking compounds.

Note 3: Information contained in this catalog represents general requirements for this Series. Contact us for the drawings and specifications for a specific part number shown.

## ■ Ordering Information

### ● Socket, Header

**DF33** **R** - **2** **S** - **3.3** **C**

① ② ③ ④ ⑤ ⑥

### ● Contacts

**DF33A** - **2022** **SCF**

① ⑦ ⑧

① Series name: DF33	④ Connector type S : Single-row socket DS : Double-row socket P : Single-row header DP : Double-row header RS : Single-row retainer RDS : Double-row retainer	⑥ Type of housing C : Crimp housing DSA : Straight header
② Guide key type Blank : Inside (Color: natural) R : Right side (Color: black)		⑦ Applicable conductor 2022 : AWG 20 to AWG 22
③ Number of contacts : 2 to 6(Single row) 4 to 12(Double row)	⑤ Contact pitch : 3.3 mm	⑧ Packaging SCF : Socket contacts / reel SC : Socket contacts / bag

## ■Single row - Straight header

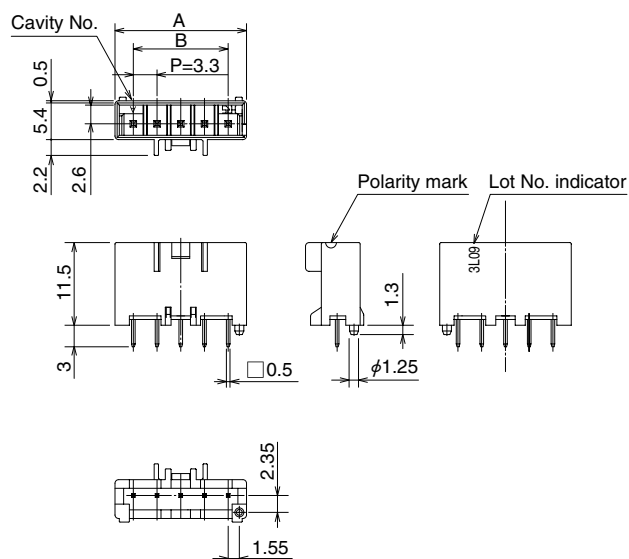
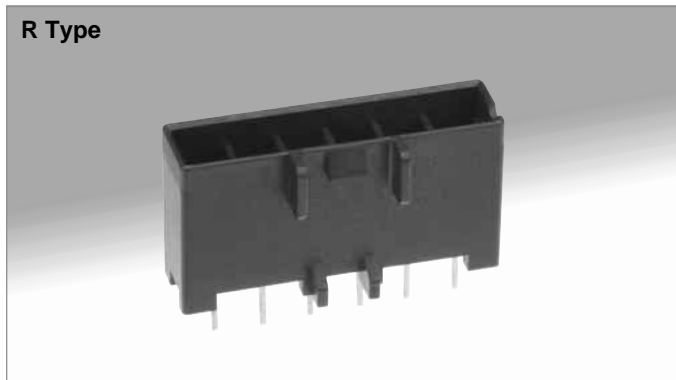
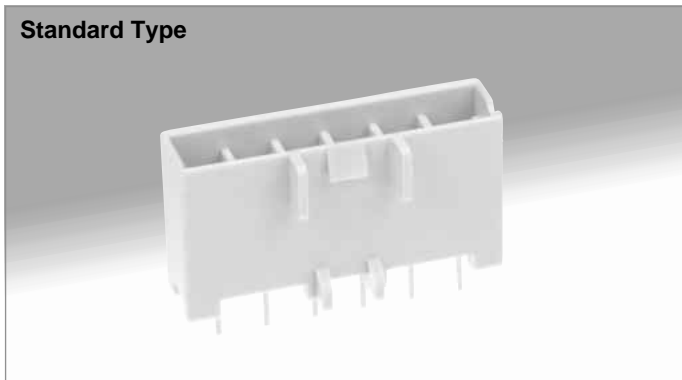

Order by number of tray Q'ty.

### Standard Type (Guide Key: Inside, Color: Natural Beige)

Pat number	CL No.	No. of contacts	A	B	Q'ty/tray
DF33-2P-3.3DSA(24)	676-1016-4-24	2	8.4	3.3	135
DF33-3P-3.3DSA(24)	676-1017-7-24	3	11.7	6.6	95
DF33-4P-3.3DSA(24)	676-1018-0-24	4	15.0	9.9	75
DF33-5P-3.3DSA(24)	676-1019-2-24	5	18.3	13.2	60
DF33-6P-3.3DSA(24)	676-1020-1-24	6	21.6	16.5	50

### R Type (Guide Key: Right Side, Color: Black)

Pat number	CL No.	No. of contacts	A	B	Q'ty/tray
DF33R-2P-3.3DSA(24)	676-1043-7-24	2	8.4	3.3	135
DF33R-3P-3.3DSA(24)	676-1044-0-24	3	11.7	6.6	95

## ■PCB mounting pattern (Board thickness: 1.6±0.1)

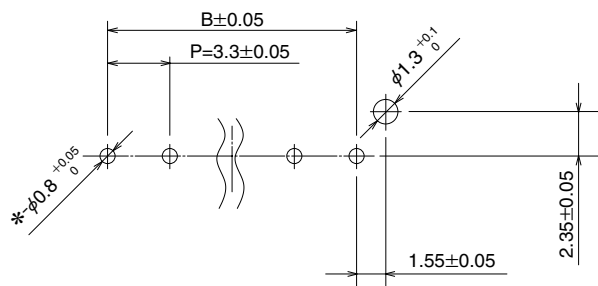

## ■Mating Dimensions

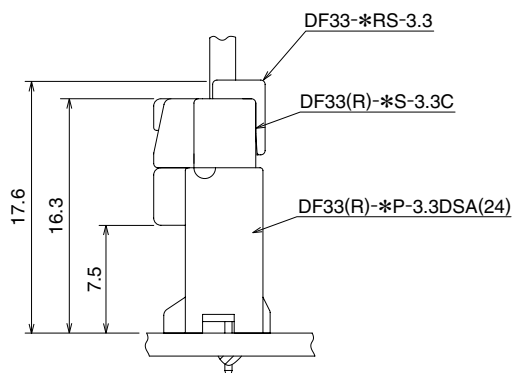

Note: Retainer is comment. Standard type and R type.

## ■ Double row - Straight header

Standard Type

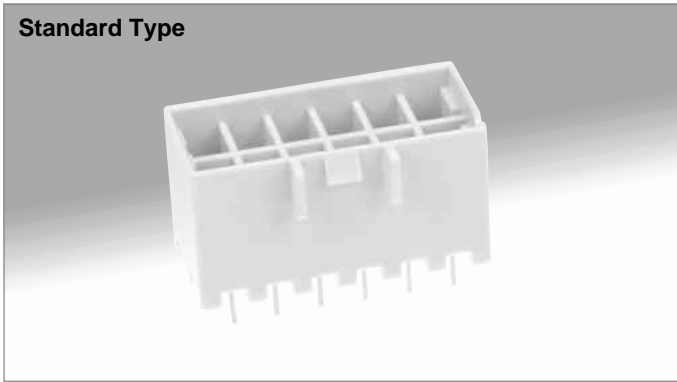

R Type



**Standard Type (Guide Key: Inside, Color: Natural Beige)**

Pat number	CL No.	No. of contacts	A	B	Q'ty/tray
DF33-4DP-3.3DSA(24)	676-1001-7-24	4	8.4	3.3	135
DF33-6DP-3.3DSA(24)	676-1002-0-24	6	11.7	6.6	95
DF33-8DP-3.3DSA(24)	676-1003-2-24	8	15.0	9.9	75
DF33-10DP-3.3DSA(24)	676-1004-5-24	10	18.3	13.2	60
DF33-12DP-3.3DSA(24)	676-1005-8-24	12	21.6	16.5	50

**R Type (Guide Key: Right Side, Color: Black)**

Please contact your Hirose sales representative for details.

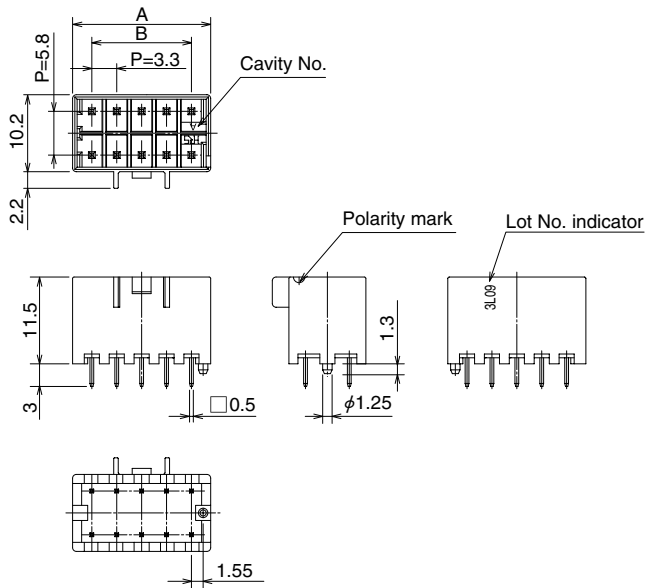

Order by number of tray Q'ty.

## ■ PCB mounting pattern (Board thickness: 1.6±0.1)

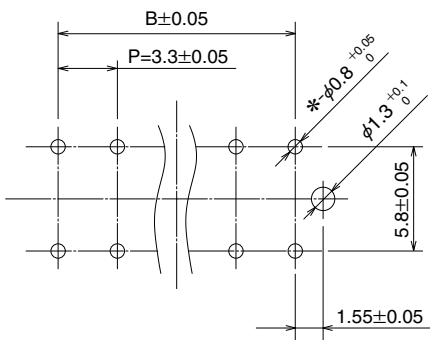

## ■ Mating Dimensions

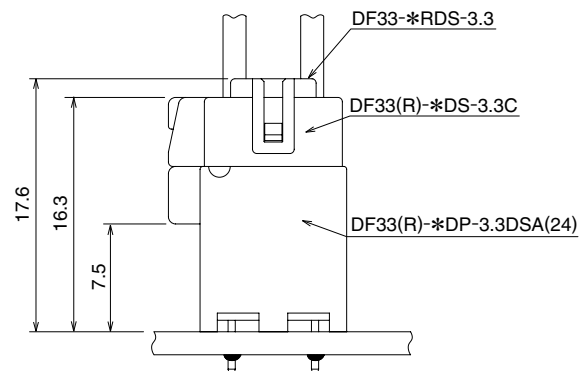

Note: Retainer is comment. Standard type and R type.

## Single row - Crimp socket

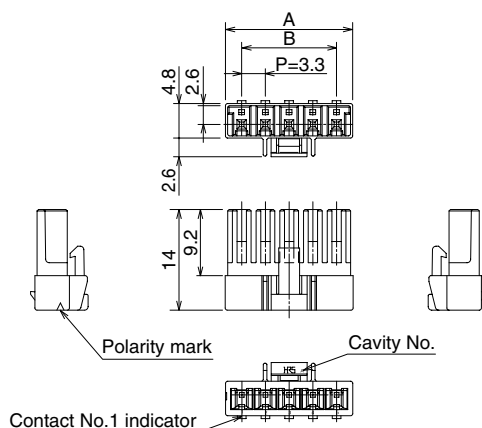
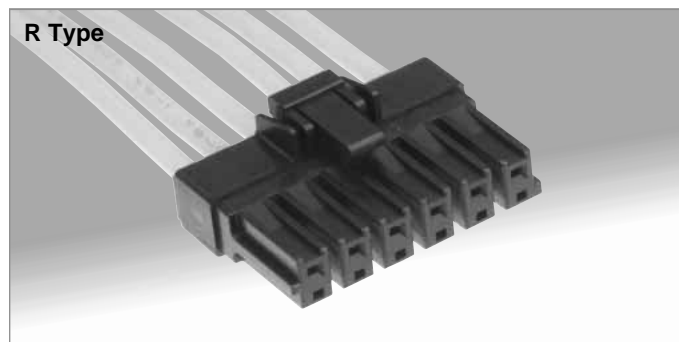
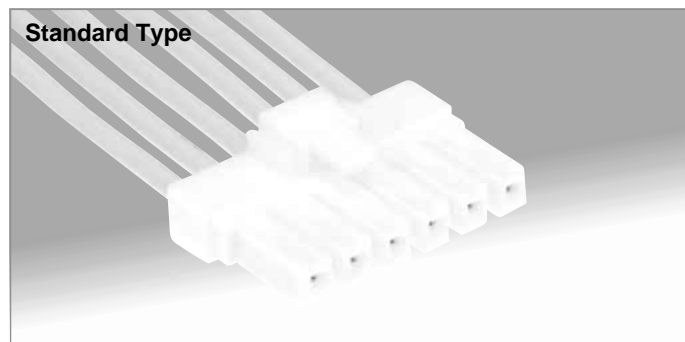

### Standard Type (Guide Key: Inside, Color: Natural Beige)

Pat number	CL No.	No. of contacts	A	B
DF33-2S-3.3C	676-1021-4	2	7.8	3.3
DF33-3S-3.3C	676-1022-7	3	11.1	6.6
DF33-4S-3.3C	676-1023-0	4	14.4	9.9
DF33-5S-3.3C	676-1024-2	5	17.7	13.2
DF33-6S-3.3C	676-1025-5	6	21.0	16.5

### R Type (Guide Key: Right Side, Color: Black)

Pat number	CL No.	No. of contacts	A	B
DF33R-2S-3.3C	676-1048-0	2	7.8	3.3
DF33R-3S-3.3C	676-1049-3	3	11.1	6.6

Note: bag packaging (100 pieces/bag). Order by number of bags.  
 Refer to next page for retainer.

## Double row - Crimp socket

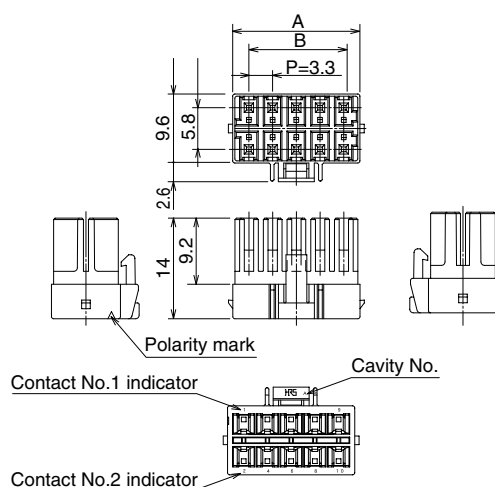
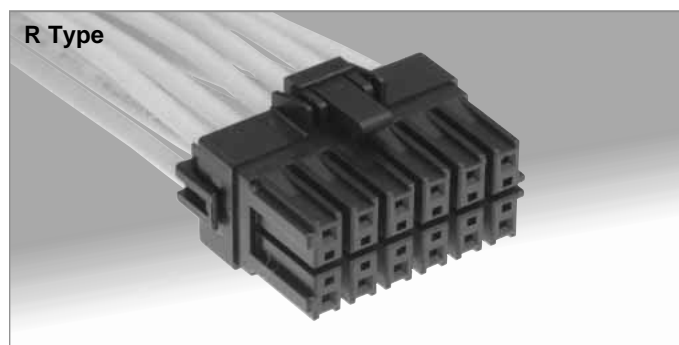
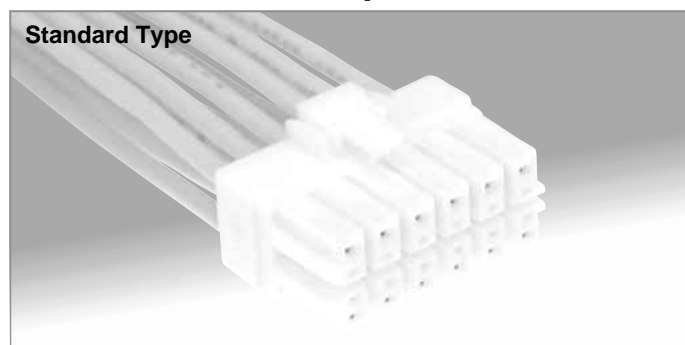

### Standard Type (Guide Key: Inside, Color: Natural Beige)

Pat number	CL No.	No. of contacts	A	B
DF33-4DS-3.3C	676-1006-0	4	7.8	3.3
DF33-6DS-3.3C	676-1007-3	6	11.1	6.6
DF33-8DS-3.3C	676-1008-6	8	14.4	9.9
DF33-10DS-3.3C	676-1009-9	10	17.7	13.2
DF33-12DS-3.3C	676-1010-8	12	21.0	16.5

### R Type (Guide Key: Right Side, Color: Black)

Please contact your Hirose sales representative for details.

Note: bag packaging (100 pieces/bag). Order by number of bags.  
 Refer to next page for retainer.

## ■ Single row - retainer

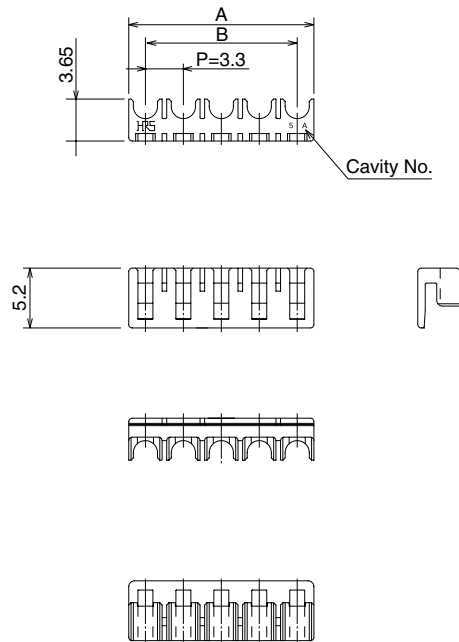
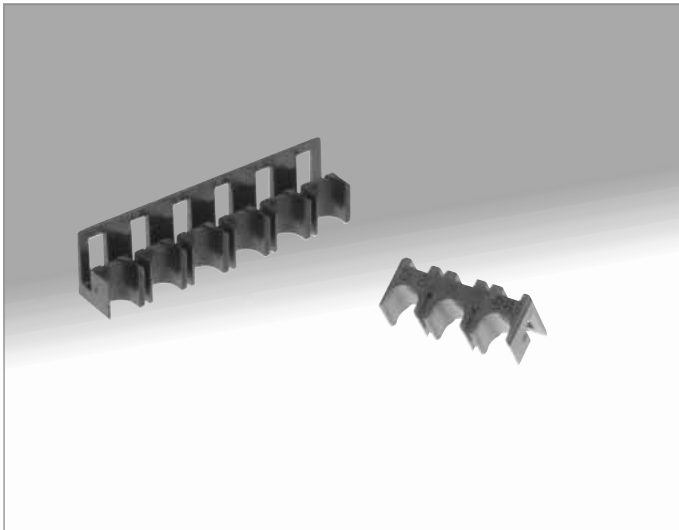

Pat number	CL No.	No. of contacts	A	B
DF33-2RS-3.3	676-1026-8	2	6.2	3.3
DF33-3RS-3.3	676-1027-0	3	9.5	6.6
DF33-4RS-3.3	676-1028-3	4	12.8	9.9
DF33-5RS-3.3	676-1029-6	5	16.1	13.2
DF33-6RS-3.3	676-1030-5	6	19.4	16.5

Note: Bag packaging (100 pieces/bag). Order by number of bags.

## ■ Double row - retainer

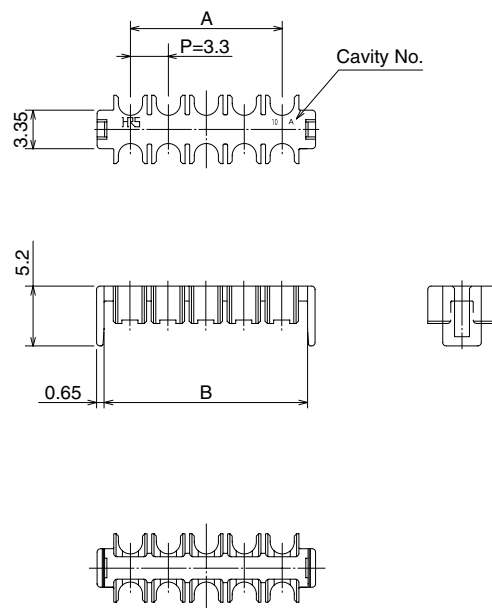
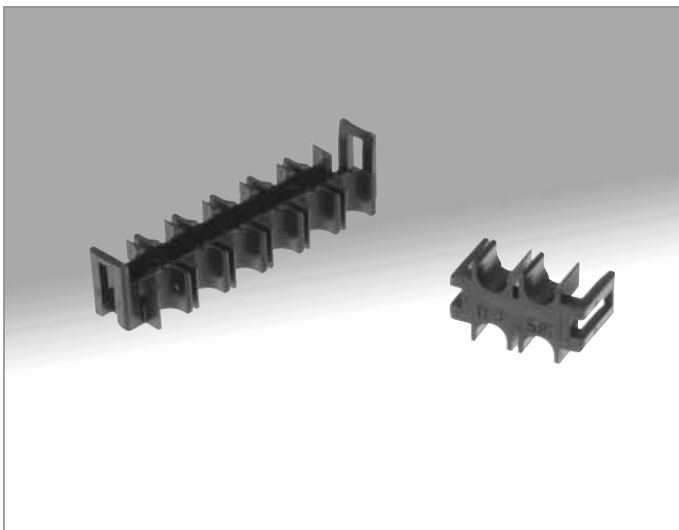

Pat number	CL No.	No. of contacts	A	B
DF33-4RDS-3.3	676-1011-0	4	3.3	8.0
DF33-6RDS-3.3	676-1012-3	6	6.6	11.3
DF33-8RDS-3.3	676-1013-6	8	9.9	14.6
DF33-10RDS-3.3	676-1014-9	10	13.2	17.9
DF33-12RDS-3.3	676-1015-1	12	16.5	21.2

Note: Bag packaging (100 pieces/bag). Order by number of bags.

## ■ Crimp contact for socket

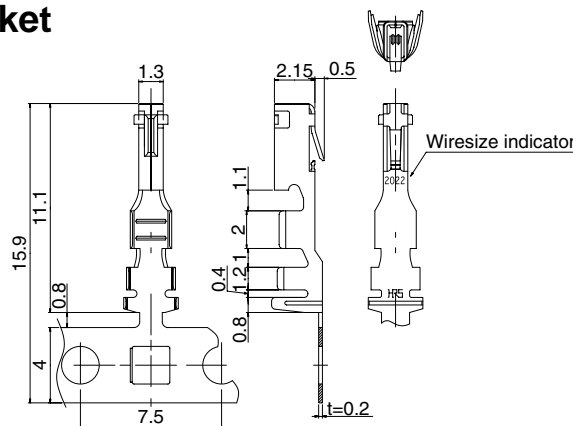

Part Number	CL No.	Applicable cable				Packaging
		UL Style	Jacket diameter	Wire size	Stranded wire conductor	
DF33A-2022SCF	676-1093-5	1007	1.5 to 1.9mm	AWG#20	21/0.18mm	10,000 pcs./reel
DF33A-2022SC	676-1094-8			AWG#22	17/0.16mm	100 pcs./bag

Note 1: Applicable wire with tin plated solid soft conductor.

Note 2: When using other than the recommended wire, contact your nearest Hirose representative.

Note 3: Strip length: 2.7 to 3.5mm

## ■ Tools

Type	Item	Part Number	CL No.	Applicable contacts
Automatic	Applicator	AP105-DF33-2022S	901-4603-8	DF33A-2022SCF
Manual	Crimp tool	HT102/DF33-2022S	550-0290-0	DF33A-2022SC
—	Contact extraction tool	DF33-C-PO	902-4551-2	DF33A-2022SC(F)

## ■ Contact Extraction

■ Contact extraction tool : DF33-C-PO

■ Intended crimp Contacts: DF33A-2022SC(F)

■ Work Method : DF33-\*S-3.3C, DF33A-2022SCF

### Housing Cross-Sectional Diagram

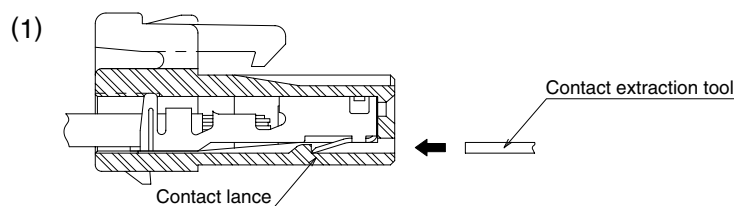

1. Refer to the drawing No. 1. Insert contact extraction tool in the insulator against the lance. Deflect the lance as shown.

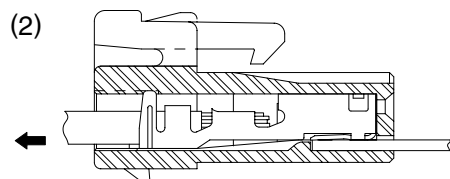

2. Assure that the lance is deflected to release the contact and pull-out wire with the terminated contact.

## ⚠ Cautions

Take particular care in removing the contact, thus not being subject to injury at convex portion edge of the crimping contact.

## ■Precautions

- Forcefully unmating the connectors will risk damaging them; therefore, when it is difficult to unmate a connector, first gently press down on it, then release the lock to allow removal.
- When performing a potting process, pay attention to the surface tension of the resin and fill the resin accordingly.
- Depending on the method by which wires have been routed within the equipment, tension may be exerted on the wires and a load applied to the contacts. Use of a retainer is recommended because of this.
- When reusing crimp contacts, raise the lance.
- Depending on the manufacturing lot and the storage conditions that have been used, the shade of the molded parts may change somewhat; however, this will not affect performance.

## ■Rating

The rated current listed in the catalog indicates the nominal current per contact. When all contacts will be carrying current, use a current limited to about one third of the listed rating.

Note that even when the rated current of the connector body is 3 A, when the nominal current of the specified wire is 1 A, the connector shall be used to handle 1 A overall.

Also, do not mate or unmate by hot plug. (See Note 1)

Note 1: The hot wire means that the wires are mated or unmated while electricity is being supplied to them.

## ■Application Environment

Please contact us when the application environment is such that the equipment will be used under repetitively hot and cold temperatures.



---

## **HIROSE ELECTRIC CO.,LTD.**

5-23,OSAKI 5-CHOME,SHINAGAWA-KU,TOKYO 141-8587,JAPAN  
PHONE: 81-3-3491-5300, FAX: 81-3-3495-5230  
<http://www.hirose.com>  
<http://www.hirose-connectors.com>

---



## X-ON Electronics

Largest Supplier of Electrical and Electronic Components

*Click to view similar products for [Crimpers](#) category:*

*Click to view products by [Hirose](#) manufacturer:*

Other Similar products are found below :

[576771-1](#) [576788-2](#) [010-0041](#) [010-0055](#) [010-0096](#) [604228-1](#) [M225202-37](#) [CT150-2-D02](#) [CT150-4-LY2](#) [CT150-6-RH07](#) [M322](#) [63484-3701](#)  
[63800-0140](#) [63800-8355](#) [63811-3275](#) [63811-3376](#) [63811-6375](#) [63811-6475](#) [63811-7875](#) [63811-8175](#) [63811-8875](#) [63819-0475](#) [63819-1875](#)  
[63819-2875](#) [63819-4375](#) [63819-4475](#) [63823-3475](#) [63823-5175](#) [63823-6375](#) [63823-8375](#) [63827-5375](#) [64001-0975](#) [64001-2175](#) [64001-4175](#)  
[662903-2](#) [690142-4](#) [690602-6](#) [D38999/20WA98JB-LC](#) [7-1633664-2](#) [7-22278-0](#) [7-22280-5](#) [7-240641-3](#) [762637-1](#) [808714-1](#) [8-1633117-3](#)  
[853721-6](#) [91362-1](#) [995-0001-187](#) [1-1633932-5](#) [999-50-020083](#)