

GT32 Series

— Shielded connector for high speed transmission / USB3.0, HDMI1.4 —

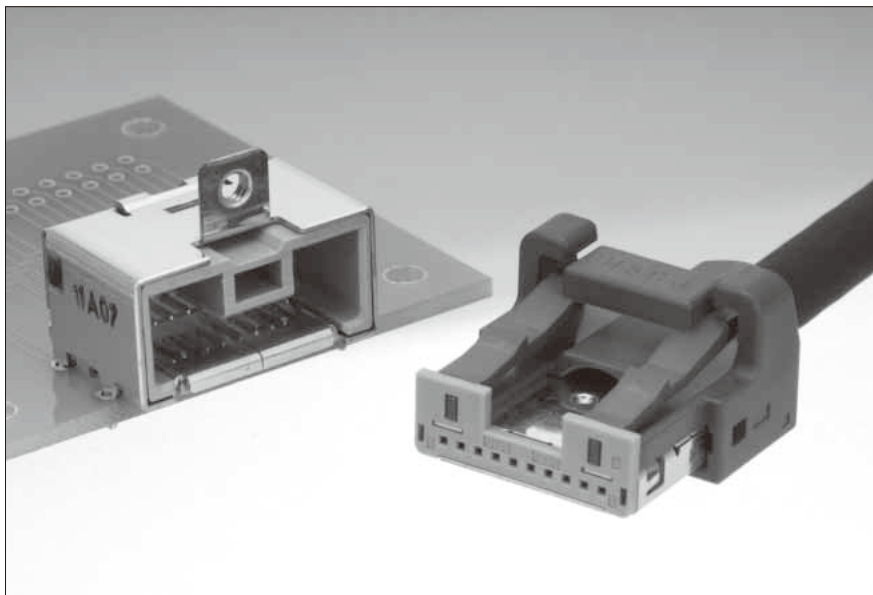

■ Features

- Full shielded structure
- Suitable for in-vehicle shielded connectors

■ Applications

In-vehicle data communication, etc.
(10-pos : USB3.0 support)
(19-pos : HDMI1.4 equivalent signal support)

F connector

Center terminal

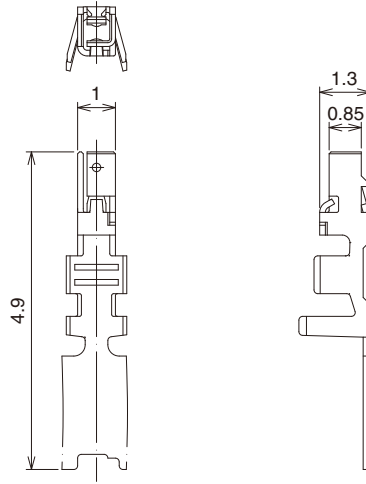
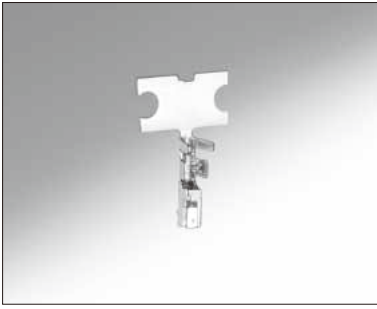

Part No.	HRS No.	Material	Plating	Conductor Size (AWG)	Outer Diameter	Packaging	RoHS
GT32-2428SCF	782-0007-8	Copper alloy	Tin plating	24 to 28 AWG	φ 0.8 to 1.0	10,000 pcs/reel	YES

10-pos straight plug connector

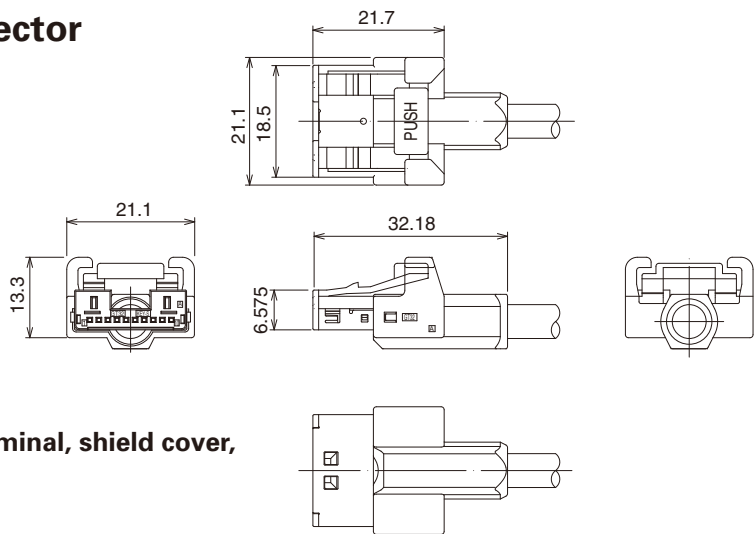
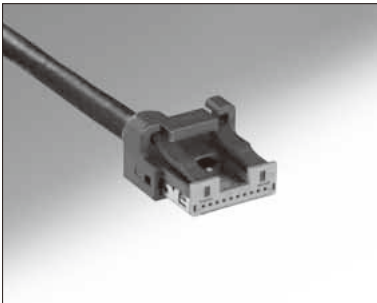

◆ This product consists of six parts.
(Housing, S insulation case, outer terminal, shield cover, shield plate, center terminal)

Housing

Part No.	HRS No.	Material	Color	Packaging	RoHS
GT32-10S-HU	782-0003-7	PBT	Dark Gray	1	YES

S insulation case

Part No.	HRS No.	Material	Color	Packaging	RoHS
GT32-10S-1.5C	782-0002-4	PBT	Light Gray	1	YES

Outer terminal

Part No.	HRS No.	Material	Plating	Outer Diameter	Packaging	RoHS
GT32-10S-6CF	782-0004-0	Copper alloy	Tin plating	φ 5.4 to 5.8	1	YES

Shield cover

Part No.	HRS No.	Material	Plating	Packaging	RoHS
GT32-10S-SC	782-0005-2	Brass	Tin plating	1	YES

Shield plate

Part No.	HRS No.	Material	Plating	Packaging	RoHS
GT32-10S-SP	782-0006-5	Brass	Tin plating	1	YES

Center terminal

Part No.	HRS No.	Material	Plating	Conductor Size (AWG)	Outer Diameter	Packaging	RoHS
GT32-2428SCF	782-0007-8	Copper alloy	Tin plating	24 to 28 AWG	φ 0.8 to 1.0	10,000 pcs/reel	YES

Mating table

Color	Cable connector	Board connector
Light Gray	GT32-10S-ASSY	Right-angle type GT32-10P-1.5H

■ 10-pos board connector (right-angle SMT type)

● M2.5 screw flange type

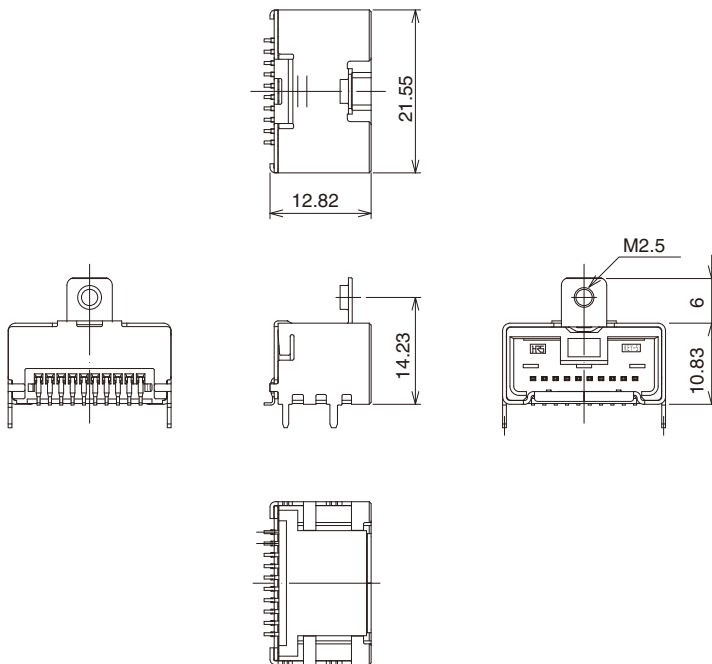
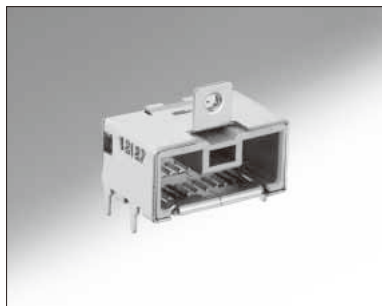

Part No.	HRS No.	Color	Material/Plating	Packaging	RoHS
GT32-10P-1.5H	782-0001-1	Light Gray	Housing : PPS Center terminal : Brass/Tin plating Outer terminal : Copper alloy/Tin plating	1	YES

GT5

GT13

GT16

PO5G

GT19

GT21

GT26

GT36

GT11

GT17

GT32

GT3

GT7

GT10

GT18W

GT25

GT8E

GT9

GT15

■ 19-pos straight connector

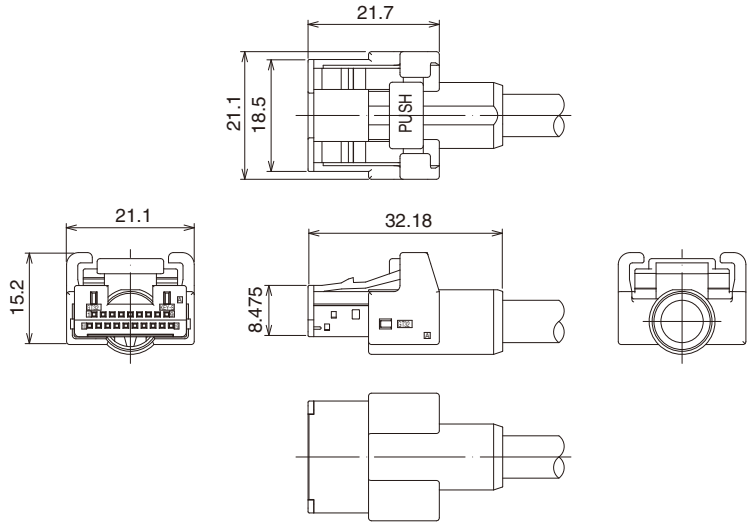
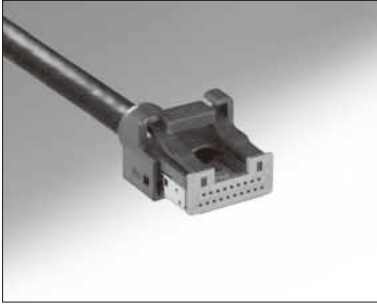

◆ This product consists of six parts.
(Housing, S insulation case A, S insulation case B, outer terminal, shield cover, center terminal)

● Housing

Part No.	HRS No.	Material	Color	Packaging	RoHS
GT32-19DS-HU	782-0013-0	PBT	Dark Gray	1	YES

● S insulation case A

Part No.	HRS No.	Material	Color	Packaging	RoHS
GT32-19DS-0.75CA	782-0010-2	PBT	Light Gray	1	YES

● S insulation case B

Part No.	HRS No.	Material	Color	Packaging	RoHS
GT32-19DS-0.75CB	782-0014-3	PBT	Light Gray	1	YES

● Outer terminal

Part No.	HRS No.	Material	Plating	Outer Diameter	Packaging	RoHS
GT32-19DS-7CF	782-0011-5	Copper alloy	Tin plating	φ 6.8 to 7.2	1	YES

● Shield cover

Part No.	HRS No.	Material	Plating	Packaging	RoHS
GT32-19DS-SC	782-0012-8	Brass	Tin plating	1	YES

● Center terminal

Part No.	HRS No.	Material	Plating	Conductor Size (AWG)	Outer Diameter	Packaging	RoHS
GT32-2428SCF	782-0007-8	Copper alloy	Tin plating	24 to 28 AWG	φ 0.8 to 1.0	10,000 pcs/reel	YES

◆ Mating table

Color	Cable connector	Board connector	
		Right-angle type	DIP type
Light Gray	GT32-19DS-ASSY	GT32-19DP-0.75H	GT32-19DP-0.75DSA

■ 19-pos board connector (right-angle SMT type)

● M2.5 screw flange type

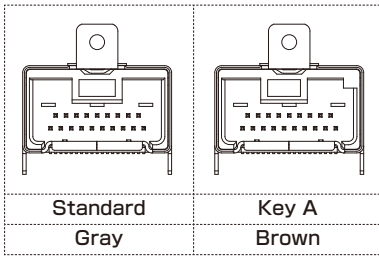
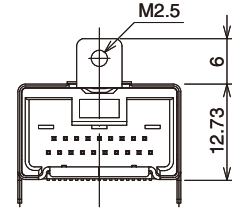
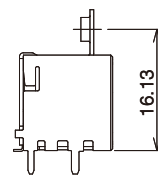
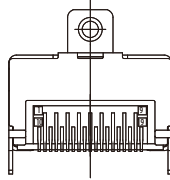
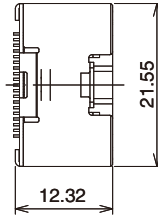
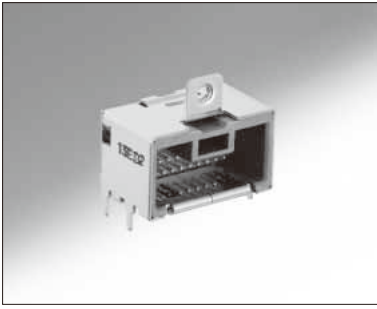

Standard
Gray

Key A
Brown

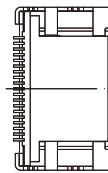

Part No.	HRS No.	Color	Material/Plating	Packaging	RoHS
GT32-19DP-0.75H	782-0009-3	Gray	Housing : PA Center terminal : Brass/Tin plating Outer terminal : Copper alloy/Tin plating	1	YES
GT32-19DP-0.75H(A)	782-0015-6	Brown			

■ 19-pos board connector (straight DIP type)

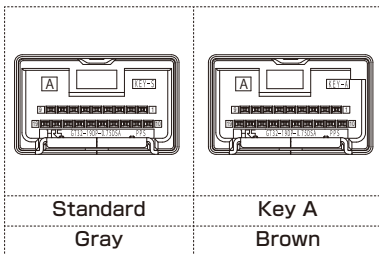
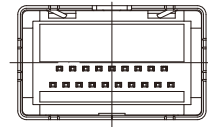
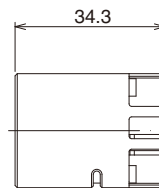
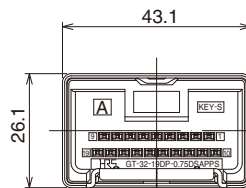
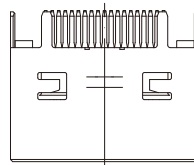

Standard
Gray

Key A
Brown

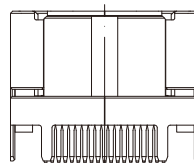

Part No.	HRS No.	Color	Material/Plating	Packaging	RoHS
GT32-19DP-0.75DSA	782-0037-9	Gray	Housing : PPS Center terminal : Brass/Tin plating Outer terminal : Copper alloy/Tin plating	1	YES
GT32-19DP-0.75DSA (A)	782-0045-7	Brown			

◆ Crimping tools

Operation manuals are available for each crimp tool. Please contact sales personnel.

● Automatic Crimping Machine

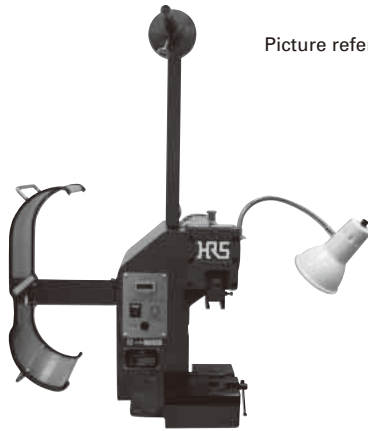

Picture reference only

Specifications

Item	Specification	Remarks
Press capacity	1.5Ton	
Stroke length	30mm	
Number of strokes	200spm (50Hz)	240spm (60Hz)
Weight	75kg	
Motor	0.2kW	AC100V
Crimping speed	2000 to 4000 pcs/hour	

Part No. CM-105C

Note : Please refer to the table below for applicator product numbers.

Applicator (for use with the automatic crimping machine)

Terminal Product No.	Terminal HRS No.	Tool Product No.	Tool HRS No.
GT32-2428SCF	782-0007-8	AP105-GT32-2428S	901-5223-2 00

Note 1 : The crimp height is to be set for each cable type. Please request your contact person for details.

Note 2 : The P/N for applicator/tool may differ from the above P/N depending on the cable specification.

Special terminal insertion tool for GT32-10S-1.5C

Terminal Product No.	Terminal HRS No.	Tool No.	Tool HRS No.
GT32-2428SCF	782-0007-8	GT32-CON/PR-MD	902-5125-0

* This product is used only to insert GT32-2428SCF terminal into S insulation case GT32-10S-1.5C.

Please note that this product cannot be used for other terminals and insulation cases.

● Hand press

Hand press

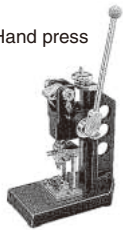

Product No. HOS-7

Outer terminal applicator (for hand press mounting)

Product Part No.	Product HRS No.	Tool Part No.	Tool HRS No.
GT32-10S-6CF	782-0004-0	GT32-10S-6/CR-MP	902-5118-4 00
		GT32-10S-6/CR-MP(01)	902-5118-4 01
GT32-19DS-7CF	782-0011-5	GT32-19DS-7/CR-MP	902-5124-7 00
		GT32-19DS-7/CR-MP(01)	902-5124-7 01

Note 1 : (01) version is to be supplied with the hand press "HOS-7".

Note 2 : The crimp height is to be set for each cable type. Please request your contact person for details.

Note 3 : The P/N for applicator/tool may differ from the above P/N depending on the cable specification.

X-ON Electronics

Largest Supplier of Electrical and Electronic Components

Click to view similar products for [Crimpers / Crimping Tools](#) category:

Click to view products by [Hirose](#) manufacturer:

Other Similar products are found below :

[010-0096](#) [M225202-37](#) [6-1579015-5](#) [CT150-2-D02](#) [M322](#) [6-304052-1](#) [63456-0054](#) [63484-3701](#) [63800-8355](#) [63819-1875](#) [63819-2875](#)
[63819-4475](#) [63823-3475](#) [63827-5375](#) [64001-0975](#) [64001-4175](#) [64005-0175](#) [662903-2](#) [690602-6](#) [7-1579001-9](#) [7-23471-1](#) [762637-1](#) [808714-](#)
[1](#) [811242-5](#) [999-50-020083](#) [1-21002-3](#) [1-21002-7](#) [12085270](#) [1-21002-6](#) [1-21113-6](#) [1-22548-4](#) [125442-1](#) [DCE.91.073.BVC](#)
[DCE.91.090.3MVM](#) [DCE.91.130.5MVU](#) [DCE.91.202.BVCM](#) [1338300-1](#) [1-354003-0](#) [1338301-1](#) [DF62/RE-MD](#) [142321](#) [1456088-1](#)
[1490794-1](#) [1-45804-6](#) [1490357-2](#) [1490357-3](#) [AX100749](#) [1-59619-7](#) [1596970-1](#) [1-59619-8](#)