

Sep.1.2021 Copyright 2021 HIROSE ELECTRIC CO., LTD. All Rights Reserved.
In case of consideration for using Automotive equipment / device which demand high reliability, kindly contact our sales window correspondents.

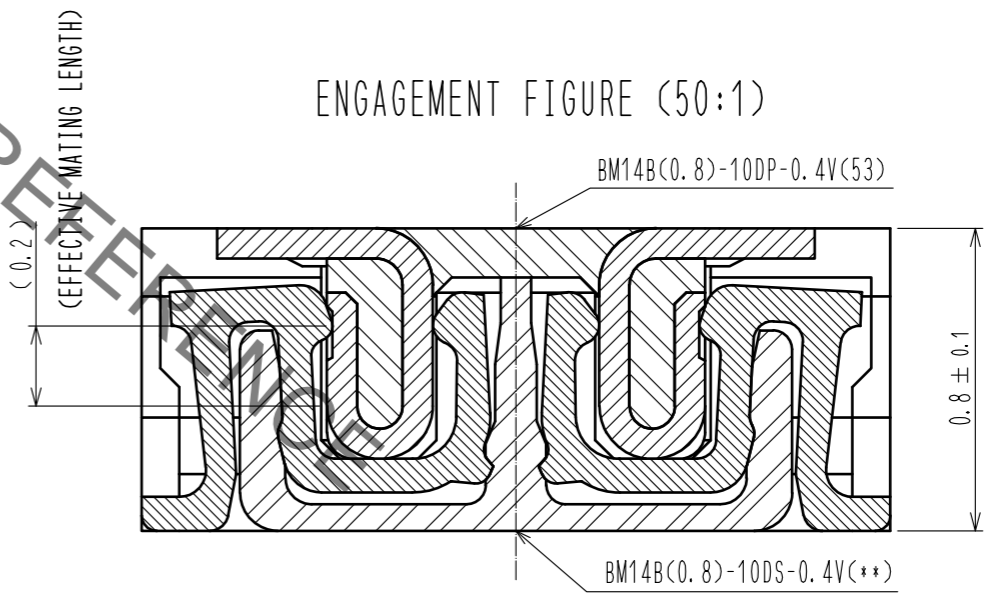
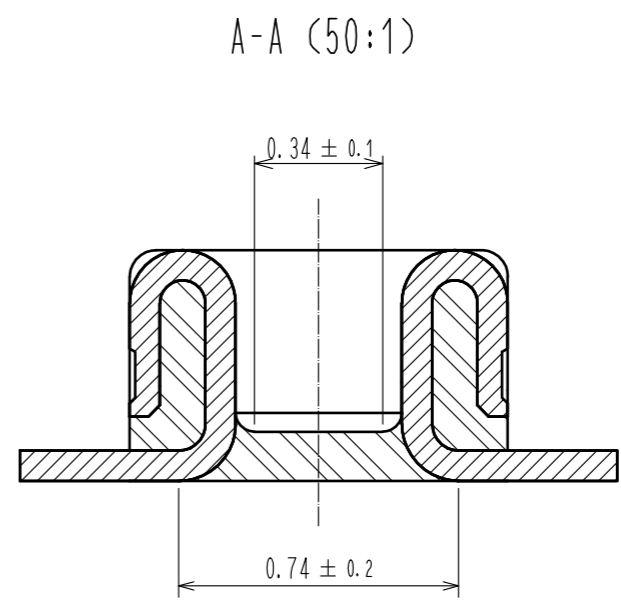
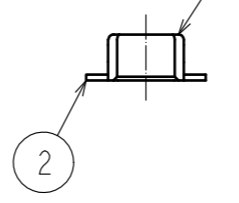
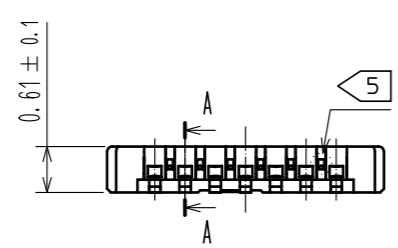
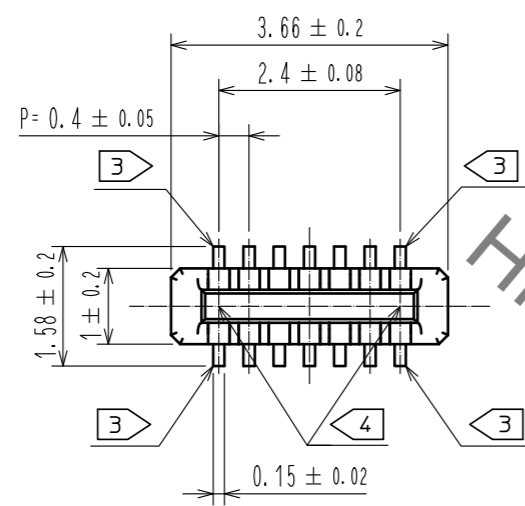

- NOTE) 1 . ALL LEAD CO-PLANARITY SHALL BE 0.08mm MAX
- 2 . CONTACT PLATING SPECIFICATIONS
 CONTACT AREA : GOLD 0.05 μm MIN
 SMT LEAD : GOLD 0.05 μm MIN
 UNDERPLATING : NICKEL 1 μm MIN
 (SURFACE : SEALING)
- 3 . EACH CONTACTS AT 4 CORNERS ARE PROVIDED FOR METAL FITTINGS AND GROUNDING PURPOSE.
- 4 . HRS MARK AND CAV No. ARE INDICATED IN APPROX POSITION SHOWN.
- 5 . A PART OF THE WALL COULD BE NOTCHED.

3	PS	CLEAR (ENBOSSED CARRIER TAPE)	6	PS	CLEAR (REINFORCEMENT COLLAR)			
2	PHOSPHOR BRONZE	2	5	PS	BLACK (PLASTIC REEL)			
1	LCP	UL94 V-0, BLACK	4	POLYESTER	CLEAR (COVER TAPE)			
NO.	MATERIAL	FINISH . REMARKS	NO.	MATERIAL	FINISH . REMARKS			
UNITS	mm	SCALE	10 : 1	COUNT	DESCRIPTION OF REVISIONS	DESIGNED	CHECKED	DATE
		APPROVED : MO. ISHIDA 17.01.19 CHECKED : TS. MIYAZAKI 17.01.19 DESIGNED : NY. YAMASHIRO 17.01.19 DRAWN : SN. NUMAZAKI 17.01.18		DRAWING NO. EDC-319845-53-00 PART NO. BM14B(0.8)-10DP-0.4V(53) CODE NO. CL684-8010-0-53		1/3		

Sep.1.2021 Copyright 2021 HIROSE ELECTRIC CO., LTD. All Rights Reserved.
In case of consideration for using Automotive equipment / device which demand high reliability, kindly contact our sales window correspondents.

◆ RECOMMENDED PCB LAYOUT

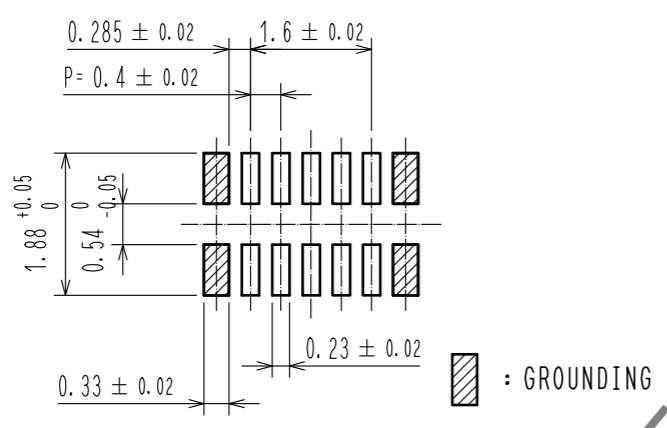

◆ RECOMMENDED METAL MASK DIMENSIONS

METAL MASK THICKNESS : 100 μm

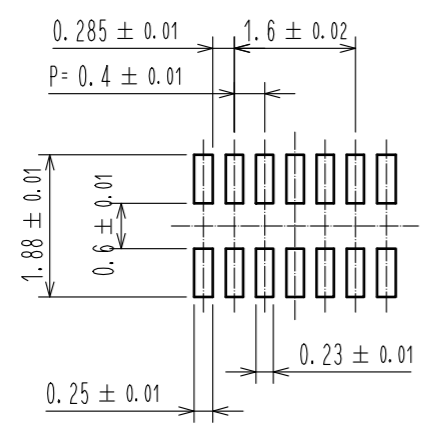

METAL MASK THICKNESS : 120 μm

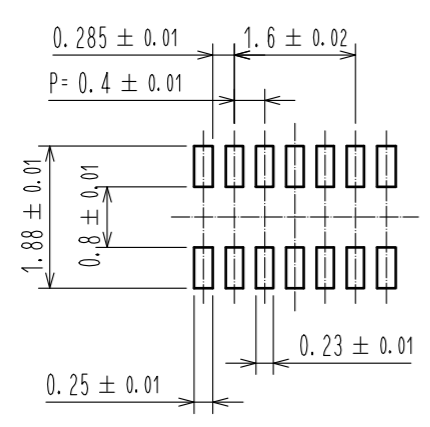

⑥ RECOMMENDED REFLOW TEMPERATURE PROFILE USING LEAD-FREE SOLDER PASTE.

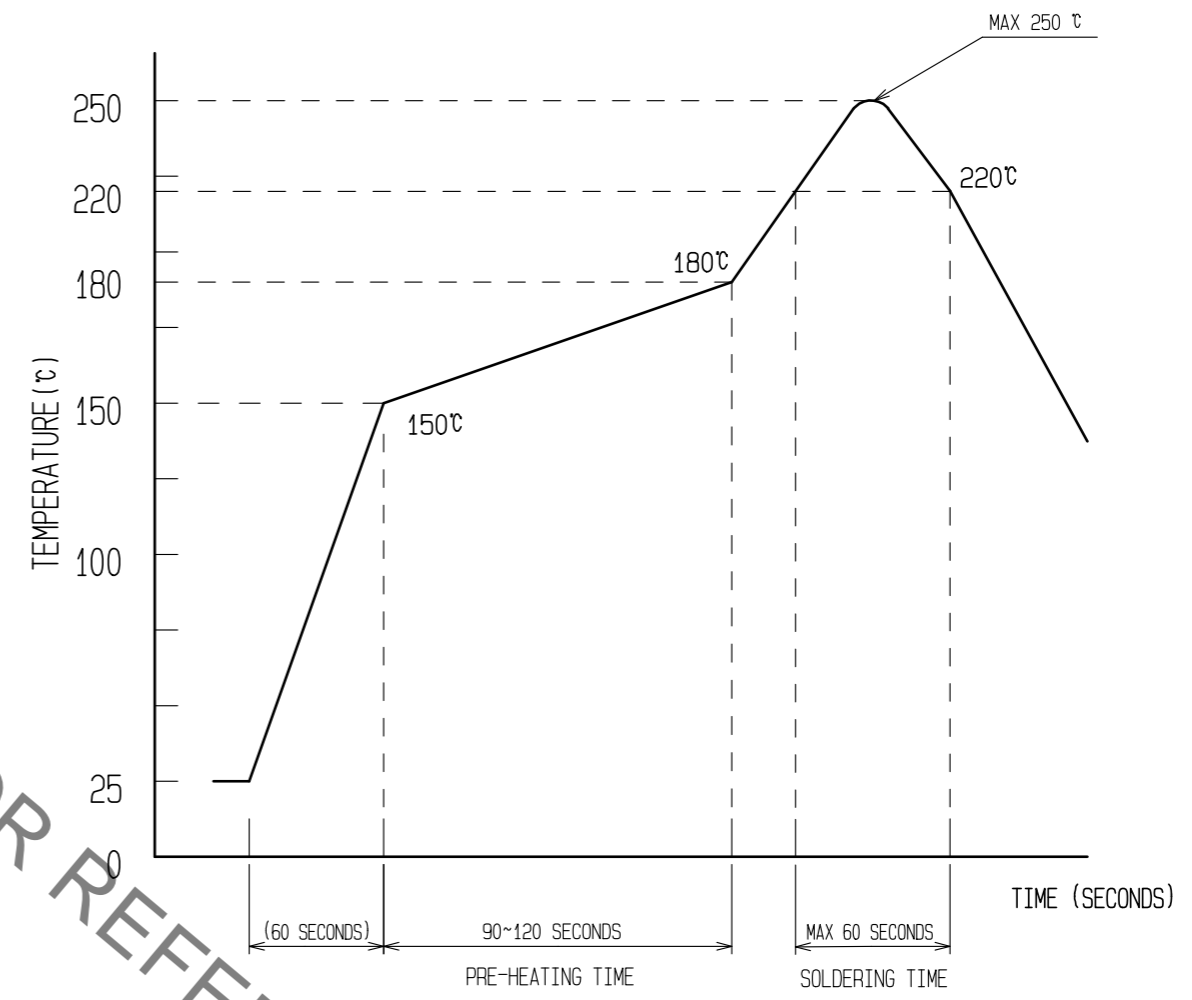

- REFLOW METHOD: IR REFLOW
 NUMBER OF REFLOW CYCLES: 2 CYCLES MAX.
 1) REFLOW TIME
 DURATION ABOVE 220°C: 60 SEC. MAX.
 (PEAK TEMPERATURE: 250°C MAX)
 2) PRE-HEAT TIME
 PRE-HEAT TEMPERATURE(MIN): 150°C
 PRE-HEAT TEMPERATURE(MAX): 180°C
 PRE-HEAT TIME: 90-120 sec.

⑥ THIS TEMPERATURE PROFILE IS PER THE CONDITIONS SHOWN ABOVE. ADDITIONAL FACTORS, SUCH AS SOLDER PASTE TYPE, PCB SIZE AND OTHER MOUNTED COMPONENTS COULD AFFECT THE PROFILE, THEREFORE, A THOROUGH EVALUATION OF MOUNTING CONDITION IS REQUIRED PRIOR TO PRODUCTION. TEMPERATURE IS MEASURED AT CONTACT LEAD.

HRS DRAWING FOR REFERENCE

HRS	DRAWING NO.	EDC-319845-53-00
	PART NO.	BM14B(0.8)-10DP-0.4V(53)
	CODE NO.	CL684-8010-0-53

Sep.1.2021 Copyright 2021 HIROSE ELECTRIC CO., LTD. All Rights Reserved.
In case of consideration for using Automotive equipment / device which demand high reliability, kindly contact our sales window correspondents.

EMBOSSED CARRIER TAPE PACKAGING (5:1)

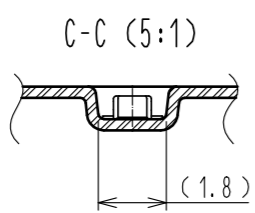
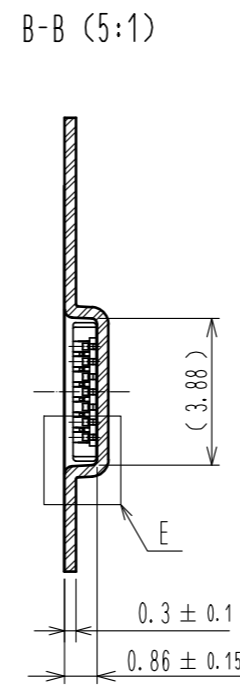
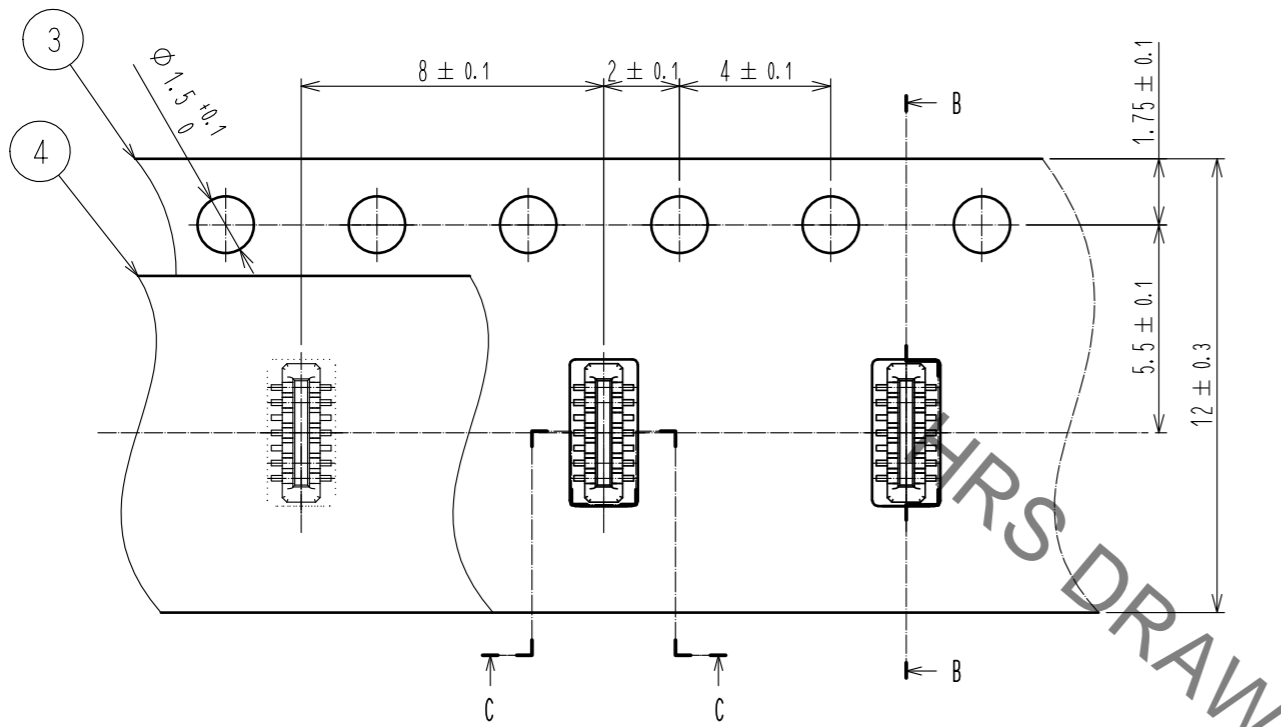

DIRECTION OF UNREELING \rightarrow

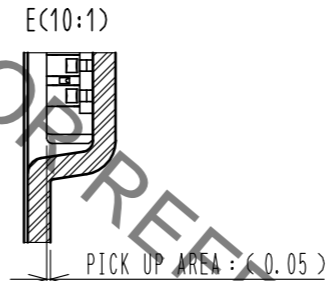

STYLE AND DIMENTION OF REEL (FREE)

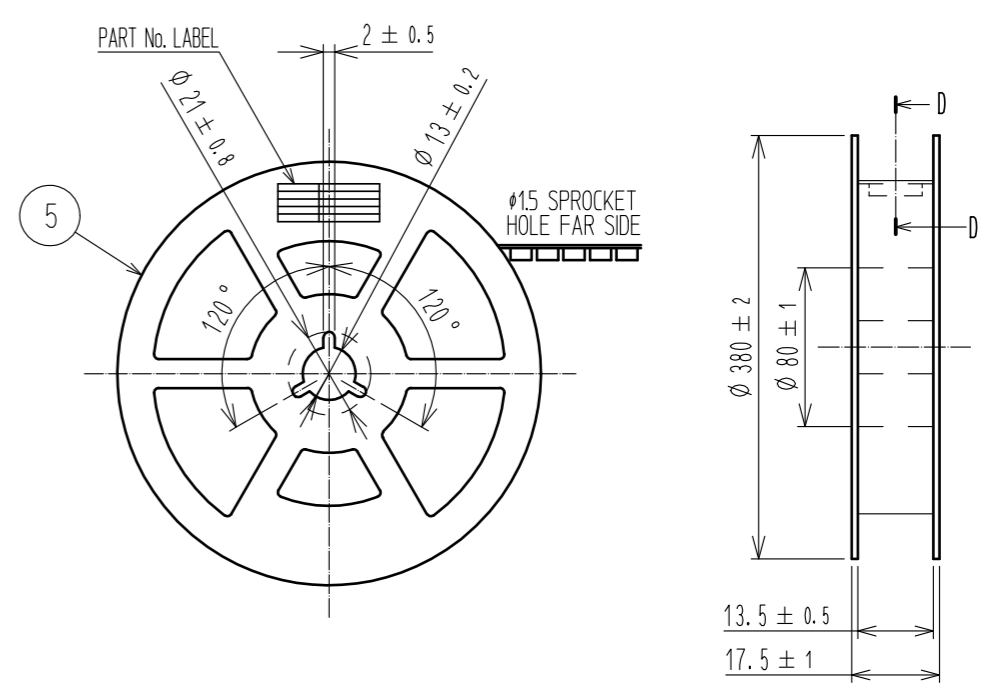

D-D (FREE)

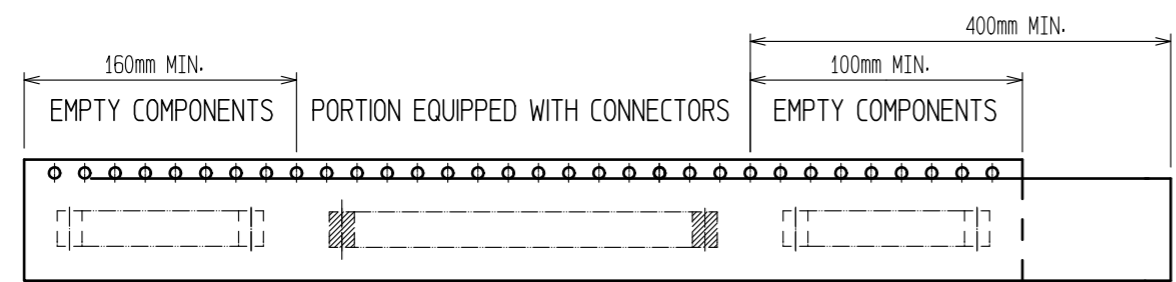
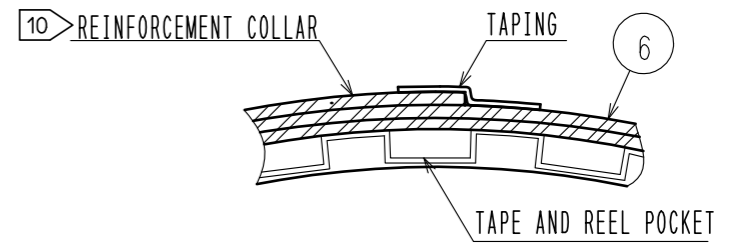

DETAIL OF PART No. LABEL

SUPPLIER	
QUANTITY	
PART No.	
CODE No.	
DATE OF MANUFACTURED	
製造年月日	** ** *
製品コード	CL684-8010-0-53
製品名	BM14B(0.8)-10DP-0.4V(53)
数量	1,000
納入者	ヒロセ電機(株)

- 7. PER REEL 1000 CONNECTORS.
- 8. THE DIMENSIONS IN PARENTHESES ARE FOR REFERENCE.
- 9 REFER TO JIS C 0806(PACKAGING OF COMPONENTS FOR AUTOMATIC HANDLING)
- 10 AFTER PACKAGING, ROLL 2 METERS OF THE REINFORCEMENT COLLAR TO OUTER CIRCUMFERENCE OF TAPE AND REEL POCKET, AND TAPE DOWN AT THE END THE COLLAR.

HRS	DRAWING NO.	EDC-319845-53-00
	PART NO.	BM14B(0.8)-10DP-0.4V(53)
	CODE NO.	CL684-8010-0-53

X-ON Electronics

Largest Supplier of Electrical and Electronic Components

Click to view similar products for [Board to Board & Mezzanine Connectors](#) category:

Click to view products by [Hirose](#) manufacturer:

Other Similar products are found below :

[589158040000018](#) [MDF7C-18P-2.54DSA\(55\)](#) [FCN-230C068-11](#) [FCN-268F012-G/BD](#) [FCN-268F036-G/BD](#) [FCN-268M012-G/0D](#) [FCN-268M024-G/1D](#) [FCN-723J004/1](#) [MIS-048-01-F-D-DP-K](#) [832-10-034-10-001000](#) [FX4C-80S-1.27DSA](#) [FCN-214Q030-G/0](#) [FCN-234P048-G/0](#) [FCN-235D050-G/C](#) [210-93-314-41-105000](#) [2-22603-0](#) [MDF7-40DP-2.54DSA\(55\)](#) [AXG720047](#) [MIT-114-03-F-D-K](#) [55323-1519](#) [DF33-2P-3.3DSA\(24\)](#) [YFT-20-05-H-03-SB-K](#) [503308-3040](#) [026-6203-PDB](#) [027-6203-PDB](#) [069159702701000](#) [10123981-102LF](#) [101A10019X](#) [55650-0588-C](#) [68682-310LF](#) [68684-306](#) [75140-7012](#) [87471-650](#) [YTW-30-07-H-Q-410-140](#) [FCN-268F024-G0D](#) [10124054-515LF](#) [68685-603](#) [8-1616154-3](#) [MIS-019-01-F-D](#) [FCN-268M024-G/3D](#) [FCN-268M036-G/BD](#) [20021832-06016C1LF](#) [KX15-20KLDL-E1000E](#) [AXE810124](#) [FCN-214J100-G/0](#) [FCN-230C068-E/S](#) [AXE812124](#) [AXE816124](#) [AXE720127](#) [354184](#)