

Sep.1.2021 Copyright 2021 HIROSE ELECTRIC CO., LTD. All Rights Reserved.
In case of consideration for using Automotive equipment / device which demand high reliability, kindly contact our sales window correspondents.

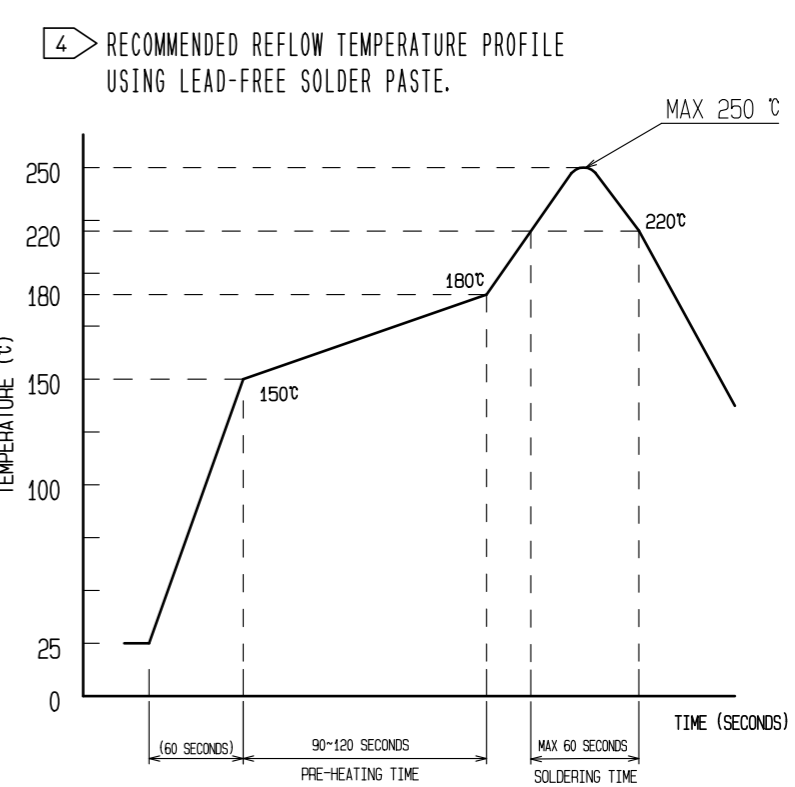

REFLOW METHOD: IR REFLOW
 NUMBER OF REFLOW CYCLES: 2 CYCLES MAX.
 1) REFLOW TIME
 DURATION ABOVE 220°C: 60 SEC MAX.
 (PEAK TEMPERATURE: 250°C MAX)
 2) PRE-HEAT TIME
 PRE-HEAT TEMPERATURE (MIN): 150°C
 PRE-HEAT TEMPERATURE (MAX): 180°C
 PRE-HEAT TIME: 90-120 SEC.

NOTE 1. ALL LEAD CO-PLANARITY SHALL BE 0.08mm MAX.
 2 CONTACT PLATING SPECIFICATIONS
 CONTACT AREA : GOLD 0.05 μm MIN
 SMT LEAD : GOLD 0.05 μm MIN
 UNDER PLATING : NICKEL 1 μm MIN
 (SURFACE : SEALING)
 3 CAV NO. AND HRS MARK EXIST IN THE INDICATED POSITION

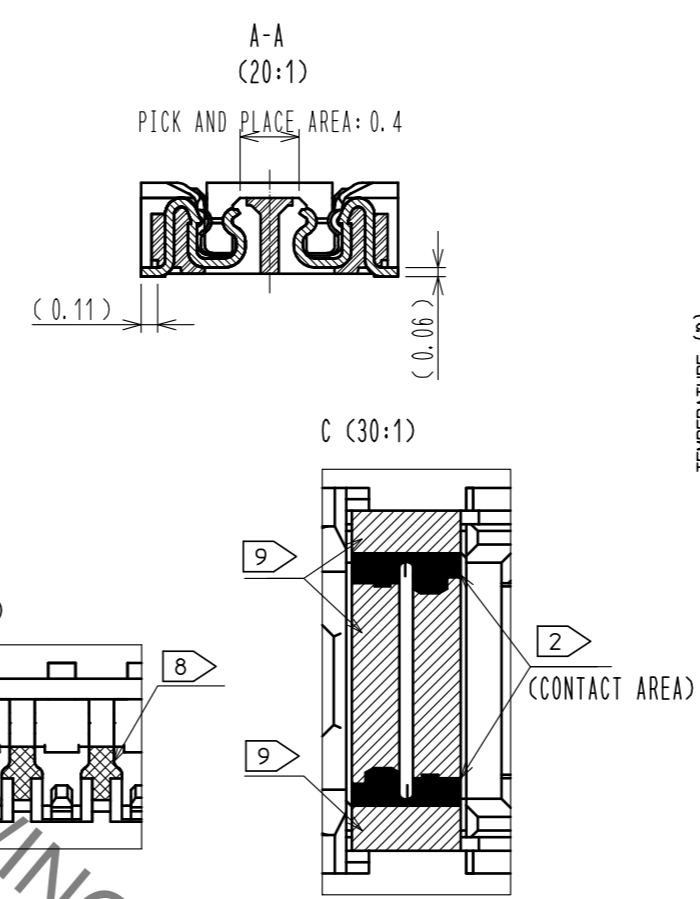
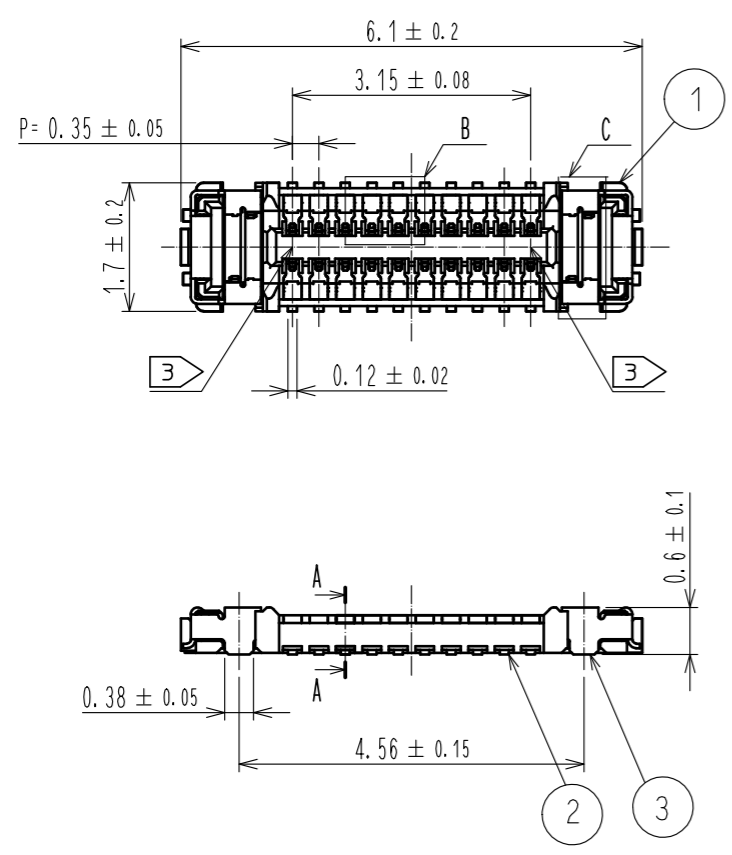
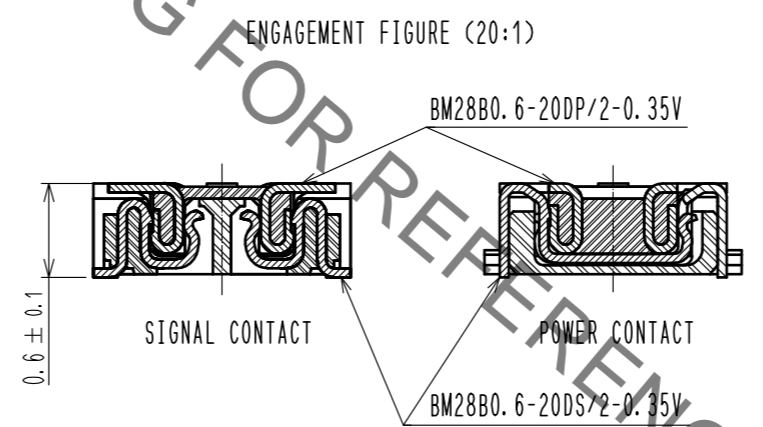

4 THIS TEMPERATURE PROFILE IS PER THE CONDITIONS SHOWN ABOVE. ADDITIONAL FACTORS, SUCH AS SOLDER PASTE TYPE, PCB SIZE AND OTHER MOUNTED COMPONENTS COULD AFFECT THE PROFILE, THEREFORE, A THOROUGH EVALUATION OF MOUNTING COONDITION IS REQUIRED PRIOR TO PRODUCTION. TEPERATURE IS MEASURED AT CONTACT LEAD.
 5. PLEASE CONTACT US IN CASE YOU WILL MAKE DIFFERENT SETTINGS FROM OUR RECOMMENDATION.
 6. THIS PRODUCT SATISFIES HALOGEN FREE REQUIREMENTS DEFINED AS 900ppm MAXIMUM CHLORINE, 900ppm MAXIMUM BROMINE, AND 1500ppm MAXIMUM TOTAL OF CHLORINE AND BROMINE.
 7. THIS PRODUCT COMPLY WITH RoHS.
 8 WELD LINE APPEARS IN THE INDICATED POSITION.
 9 NO GOLD PLATING IS ACCEPTABLE FOR THIS AREA.

1 RECOMMENDED PCB LAYOUT

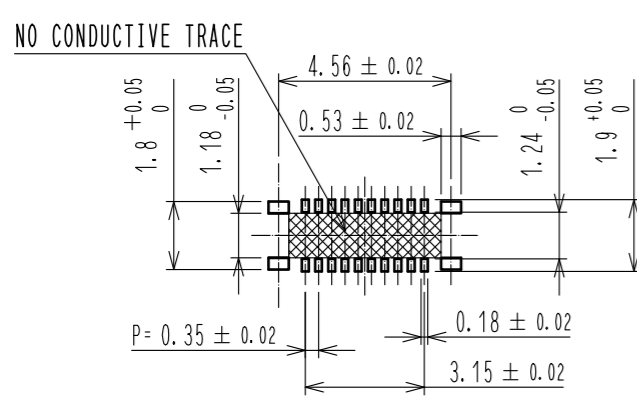

1 RECOMMENDED METAL MASK DIMENSIONS
 METAL MASK THICKNESS : 80 μm

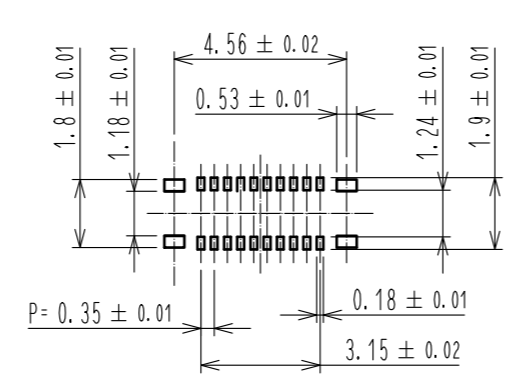

4	PS	CLEAR (EMBOSSD CARRIER TAPE)			
3	COPPER ALLOY	2	7	PS	CLEAR (REINFORCEMENT COLLAR)
2	COPPER ALLOY	2	6	PS	BLACK (PLASTIC REEL)
1	LCP	UL94 V-0, BLACK	5	POLYESTER	CLEAR (COVER TAPE)
NO.	MATERIAL	FINISH . REMARKS	NO.	MATERIAL	FINISH . REMARKS
UNITS	mm	SCALE	10 : 1	COUNT	5
		DESCRIPTION OF REVISIONS		DESIGNED	CHK. ODA
		DIS-H-00010654		CHECKED	TS. MIYAZAKI
				DATE	20210908
APPROVED : MO. ISHIDA		20170523		DRAWING NO. EDC-365212-53-00	
CHECED : TS. MIYAZAKI		20170523		PART NO. BM28B0.6-20DS/2-0.35V (53)	
DESIGNED : RT. SHIMIZU		20170523		CODE NO. CL0673-5040-0-53	
DRAWN : SN. NUMAZAKI		20170523			

Sep.1.2021 Copyright 2021 HIROSE ELECTRIC CO., LTD. All Rights Reserved.
In case of consideration for using Automotive equipment / device which demand high reliability, kindly contact our sales window correspondents.

EMBOSED CARRIER TAPE PACKAGING (5:1)

E-E (5:1)

STYLE AND DIMENSION OF REEL (FREE)

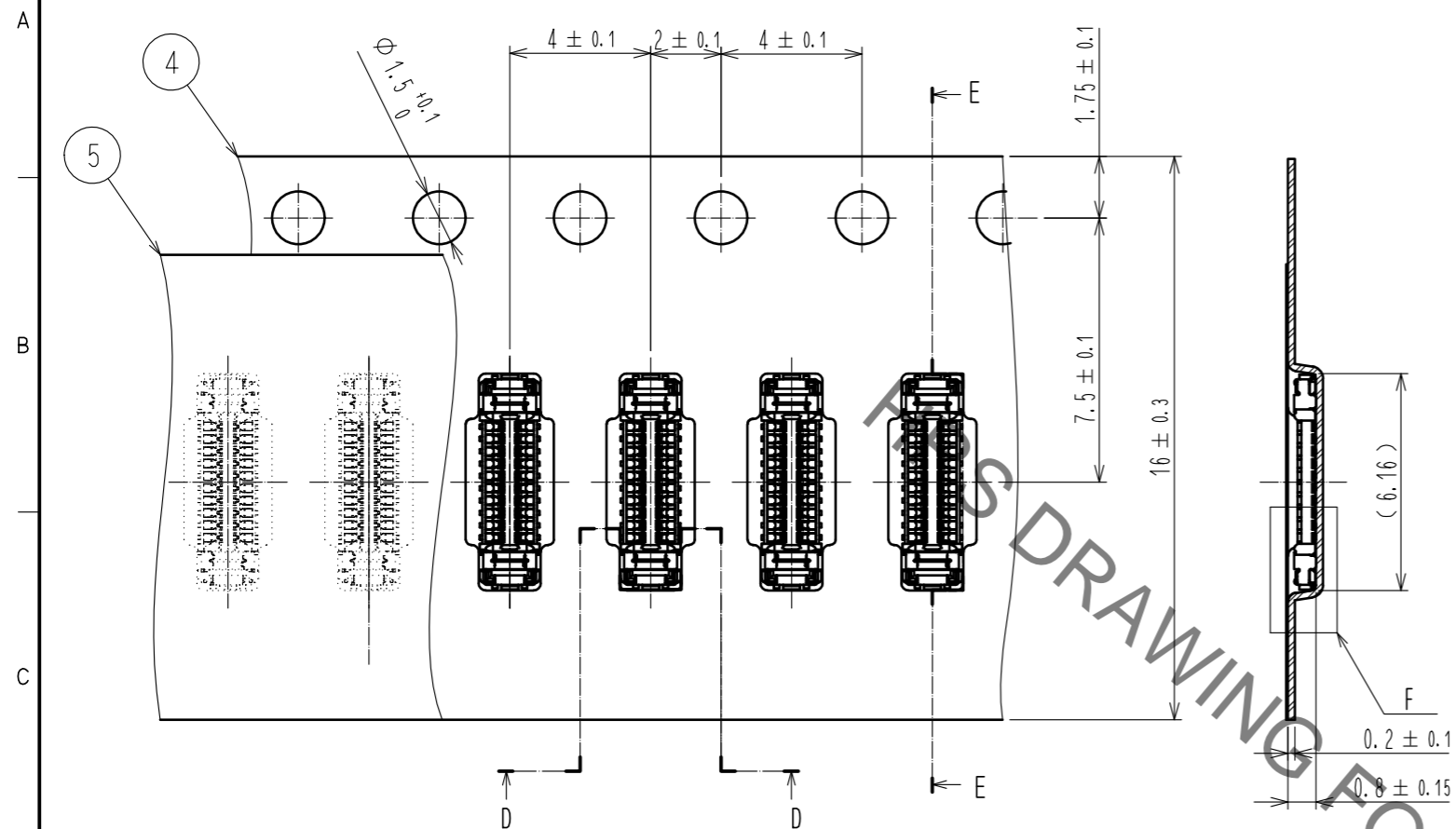

D-D (5:1)

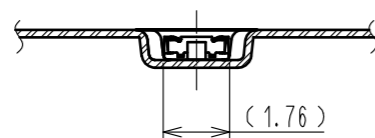

DIRECTION OF UNREELING

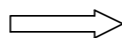

F (10:1)

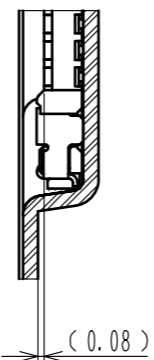

△ LABEL DELETED

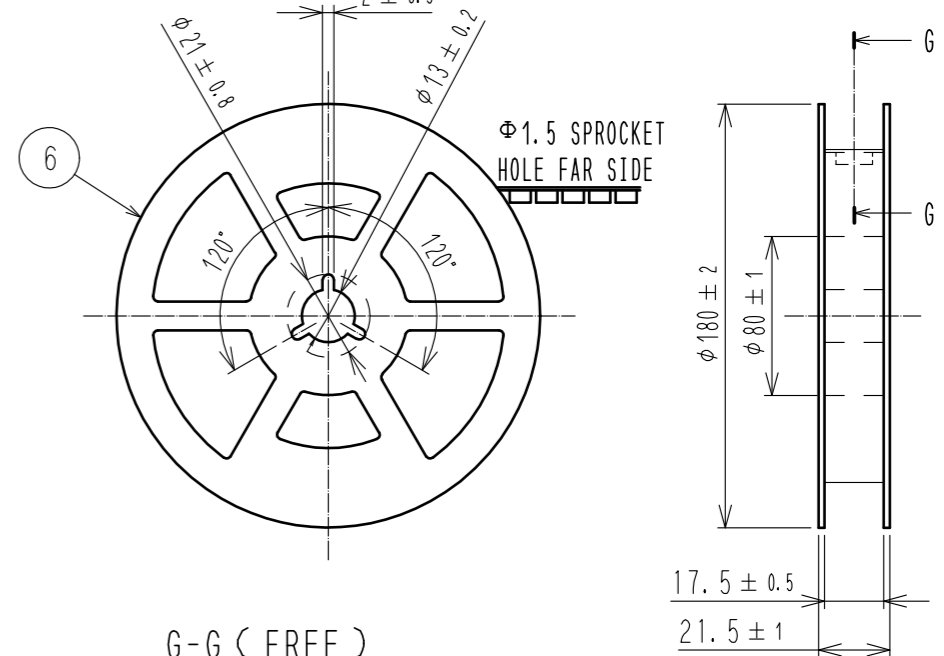

G-G (FREE)

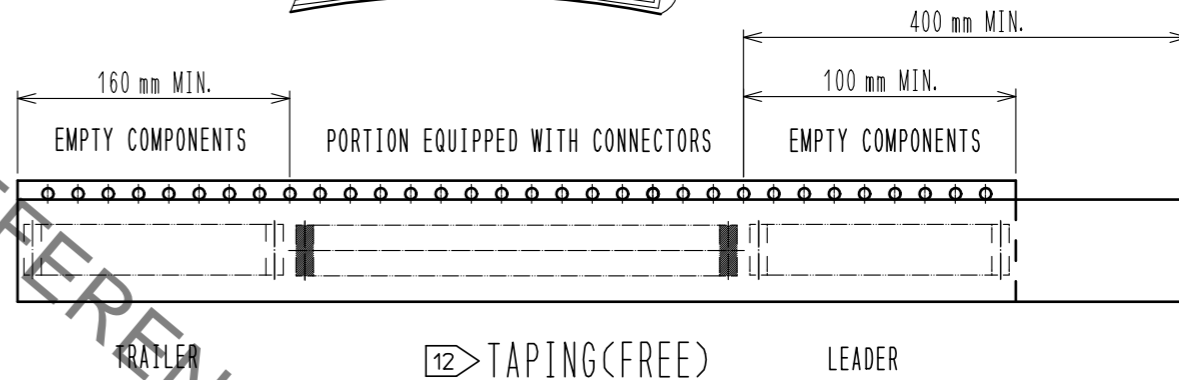
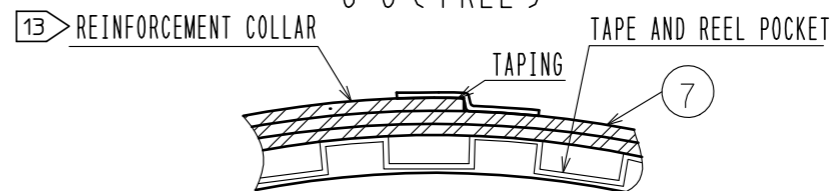

△ LABEL DELETED

- 10 . PER REEL 1,000 CONNECTORS.
- 11 . THE DIMENSIONS IN PARENTHESES ARE FOR REFERENCE.
- 12 . REFER TO JIS C 0806, IEC 60286-3(PACKAGING OF COMPONENTS FOR AUTOMATIC HANDLING)
- 13 . AFTER PACKAGING, ROLL 2 METERS OF THE REINFORCEMENT COLLAR TO OUTER CIRCUMFERENCE OF TAPE AND REEL POCKET. AND TAPE DOWN AT THE END THE COLLAR.

HRS	DRAWING NO.	EDC-365212-53-00
	PART NO.	BM28B0. 6-20DS/2-0. 35V(53)
	CODE NO.	CL0673-5040-0-53
		2/3

Sep.1.2021 Copyright 2021 HIROSE ELECTRIC CO., LTD. All Rights Reserved.
In case of consideration for using Automotive equipment / device which demand high reliability, kindly contact our sales window correspondents.

△14. PLEASE REFER TO THE PRODUCT GUIDELINE ETAD-H1016 FOR DETAIL OF CONNECTOR HANDLING.

THE POSITION BETWEEN THE CONNECTOR AND PAD

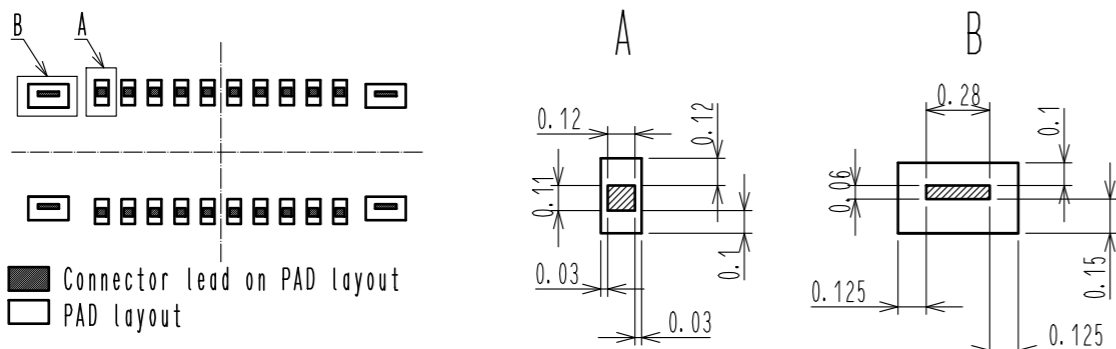

CAUTION FOR SOLDERING

THERE IS METAL EXPOSURE AREA BOTTOM OF THE CONNECTOR.
TO AVOID SOLDER WICKING FROM THE BOTTOM SIDE, PLEASE DESIGN PCB PAD AND STENCIL WITH RECOMMENDED DIMENSIONS.

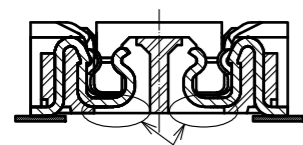

MATING METHOD

PLEASE MATE THE CONNECTOR BY HAND.

MATING PROCEDURE

- (1) FIND THE ALIGNMENT AREA TO THE CONNECTOR IN THE APPROPRIATE MATING POSITION.
THIS CONNECTOR HAS AN ALIGNMENT CHAMBER(GUIDANCE RIBS) ON RECEPTACLE SIDE AND 'R' ON PLUG SIDE, SO THAT THE CONNECTOR WILL BE SELF-ALIGNED.
WHEN THE CONNECTOR COMES TO THE APPROPRIATE POSITION, THE CONNECTOR GOES INTO THE ALIGNED POSITION.
WHEN ALIGNED, IT CAN BE FELT BY HAND.

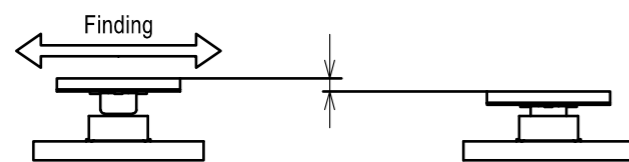
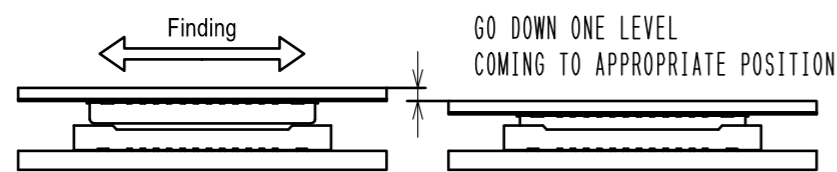

- (2) WHEN GUIDING, THE CONNECTORS ARE ALIGNED PARALLEL TO EACH OTHER, WITH LONGITUDINAL AND LATERAL MOVEMENTS RESTRICTED. MATE THEM PROPERLY BY APPLYING FORCE IN THIS CONDITION.

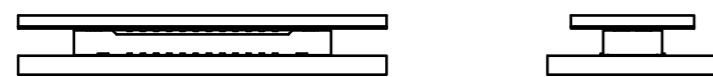

- (3) MAKE SURE THE CONNECTORS ARE MATED CORRECTLY. IF ONE SIDE IS FLOATING OR THE CONNECTORS ARE MATED IN ONE DIRECTION, UN-MATE THEM ONCE, AND THEN MATE THEM AGAIN, FOLLOWING THE PROCEDURES ABOVE FROM THE BEGINNING.

UN-MATING METHOD

PLEASE UN-MATE THE CONNECTOR BY HAND

- (1) UN-MATE THE CONNECTORS PARALLEL TO EACH OTHER. HOWEVER, IF THE CONNECTORS HAVE HIGH PIN COUNTS OR THINNER FPC AND STIFFENER, IT BECOMES MORE DIFFICULT TO DO SO.

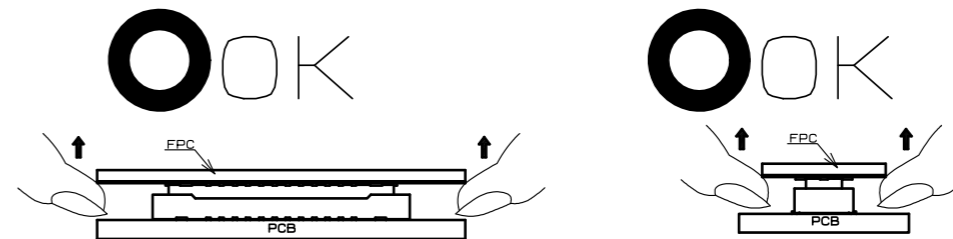

- (2) IF THE CONNECTOR CANNOT BE UN-MATED PARALLEL IT CAN BE REMOVED DIAGONALLY FROM THE PITCH DIRECTION. BE CAREFUL TO DO SO SINCE THIS ACTION APPLIES STRESS ON THE CONTACT.

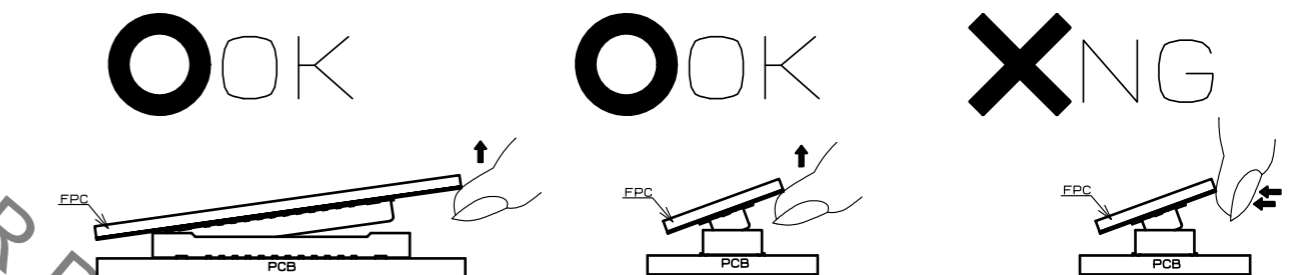

- (3) IF THE FPC IS NOT RIGID, THE CONNECTOR CAN BE BROKEN. PLEASE CHECK THE ACTION OF THE FPC TO BE USED REPEATEDLY AT THE TIME OF TRIAL PRODUCTION. BE CAREFUL TO UN-MATE THEM FROM THE PITCH DIRECTION, PULLING IT FROM THE CORNER CAN ALSO RISK TO PUTTING STRESS ON CONTACTS.

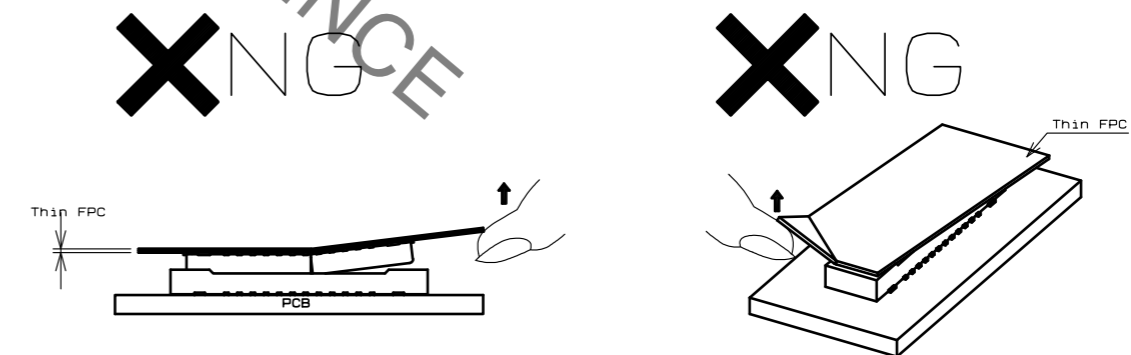

HRS	DRAWING NO.	EDC-365212-53-00
	PART NO.	BM28B0. 6-20DS/2-0.35V<53>
	CODE NO.	CL0673-5040-0-53
		△ 3/3

X-ON Electronics

Largest Supplier of Electrical and Electronic Components

Click to view similar products for [Board to Board & Mezzanine Connectors](#) category:

Click to view products by [Hirose](#) manufacturer:

Other Similar products are found below :

[589158040000018](#) [MDF7C-18P-2.54DSA\(55\)](#) [FCN-230C068-11](#) [FCN-268F012-G/BD](#) [FCN-268F036-G/BD](#) [FCN-268M012-G/0D](#) [FCN-268M024-G/1D](#) [FCN-723J004/1](#) [MIS-048-01-F-D-DP-K](#) [832-10-034-10-001000](#) [FX4C-80S-1.27DSA](#) [FCN-214Q030-G/0](#) [FCN-234P048-G/0](#) [FCN-235D050-G/C](#) [210-93-314-41-105000](#) [2-22603-0](#) [MDF7-40DP-2.54DSA\(55\)](#) [AXG720047](#) [MIT-114-03-F-D-K](#) [55323-1519](#) [DF33-2P-3.3DSA\(24\)](#) [YFT-20-05-H-03-SB-K](#) [503308-3040](#) [026-6203-PDB](#) [027-6203-PDB](#) [069159702701000](#) [10123981-102LF](#) [101A10019X](#) [55650-0588-C](#) [68682-310LF](#) [68684-306](#) [75140-7012](#) [87471-650](#) [YTW-30-07-H-Q-410-140](#) [FCN-268F024-G0D](#) [10124054-515LF](#) [68685-603](#) [8-1616154-3](#) [MIS-019-01-F-D](#) [FCN-268M024-G/3D](#) [FCN-268M036-G/BD](#) [20021832-06016C1LF](#) [KX15-20KLDL-E1000E](#) [AXE810124](#) [FCN-214J100-G/0](#) [FCN-230C068-E/S](#) [AXE812124](#) [AXE816124](#) [AXE720127](#) [354184](#)