

Aug.1.2021 Copyright 2021 HIROSE ELECTRIC CO., LTD. All Rights Reserved.  
In case of consideration for using Automotive equipment / device which demand high reliability, kindly contact our sales window correspondents.

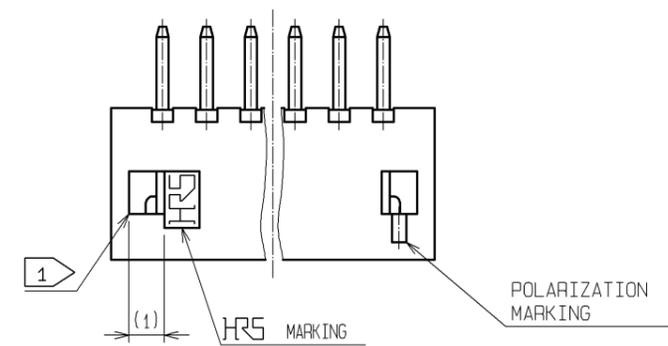

HRS DRAWING FOR REFERENCE

PART No.	CODE No.	NUMBER OF CONTACTS	A	B	C
DF13- 2P-1.25DSA	CL536-0101-9	2	1.25	3.15	4.15
DF13- 3P-1.25DSA	CL536-0102-1	3	2.5	4.4	5.4
DF13- 4P-1.25DSA	CL536-0103-4	4	3.75	5.65	6.65
DF13- 5P-1.25DSA	CL536-0104-7	5	5	6.9	7.9
DF13- 6P-1.25DSA	CL536-0105-0	6	6.25	8.15	9.15
DF13- 7P-1.25DSA	CL536-0106-2	7	7.5	9.4	10.4
DF13- 8P-1.25DSA	CL536-0107-5	8	8.75	10.65	11.65
DF13- 9P-1.25DSA	CL536-0108-8	9	10	11.9	12.9
DF13-10P-1.25DSA	CL536-0109-0	10	11.25	13.15	14.15
DF13-11P-1.25DSA	CL536-0110-0	11	12.5	14.4	15.4
DF13-12P-1.25DSA	CL536-0111-2	12	13.75	15.65	16.65
DF13-13P-1.25DSA	CL536-0112-5	13	15	16.9	17.9
DF13-14P-1.25DSA	CL536-0113-8	14	16.25	18.15	19.15
DF13-15P-1.25DSA	CL536-0114-0	15	17.5	19.4	20.4

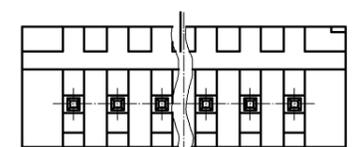
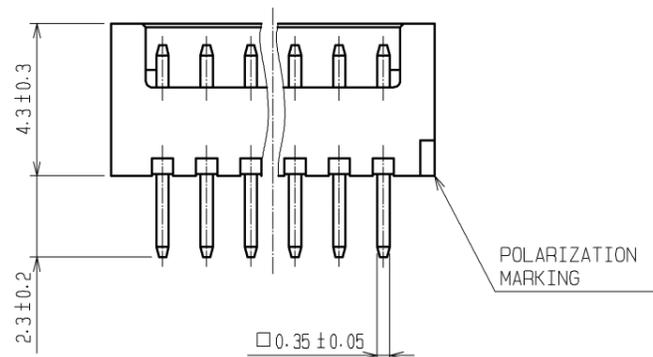
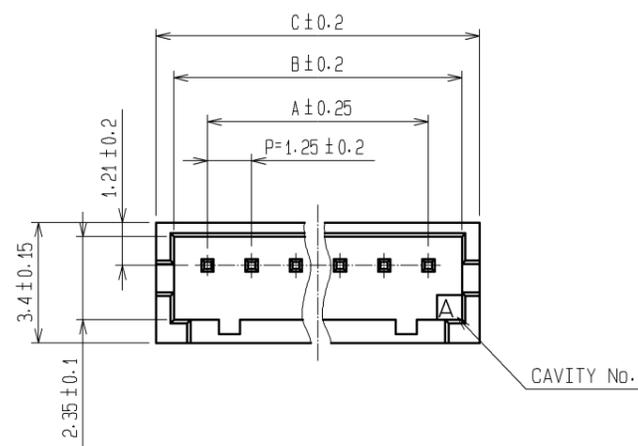
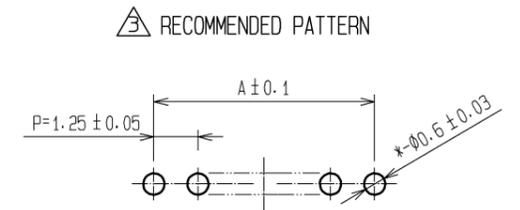
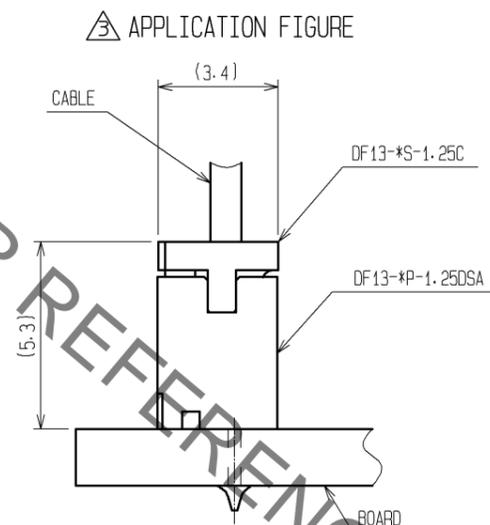
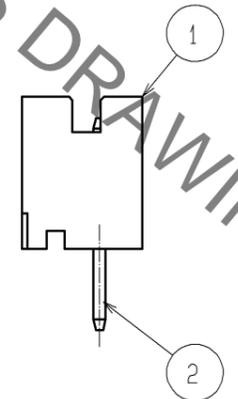

1 WHEN THIS CONNECTOR HAS TWO OR THREE CONTACTS, THE LOCK OF CONNECTOR SHALL BE SET AT THE CENTER OF HOUSING. IN CASE THAT THE NUMBER OF CONTACTS IS MORE THAN FOUR, THE TWO LOCKS SHALL BE SET IN ACCORDANCE WITH THE DRAWINGS.

3 ARTICLE DELETED

NO.	MATERIAL	FINISH	REMARKS	NO.	MATERIAL	FINISH	REMARKS
1	POLYAMIDE	BEIGE (NATURAL)	UL94V-0	2	BRASS		SURFACE:TIN PLATED 1μm min UNDER PLATING:COPPER PLATED 1μm min

UNITS	SCALE	COUNT	DESCRIPTION OF REVISIONS	DESIGNED	CHECKED	DATE
mm	5 : 1	4	DIS-H-006947	MI. SAKIMURA	HK. UMEHARA	12.06.14

APPROVED	DATE	DRAWING NO.
: KJ. KATAYOSE	05.01.05	EDC3-083673-01
CHECKED	DATE	PART NO.
: TY. OMA	05.01.05	DF13-*P-1.25DSA
DESIGNED	DATE	CODE NO.
: TS. KUMAZAWA	05.01.05	
DRAWN	DATE	
: TS. KUMAZAWA	05.01.05	

## X-ON Electronics

Largest Supplier of Electrical and Electronic Components

*Click to view similar products for [Headers & Wire Housings](#) category:*

*Click to view products by [Hirose](#) manufacturer:*

Other Similar products are found below :

[892-18-020-10-001101](#) [58102-G61-06LF](#) [582553-1](#) [0009485154](#) [009176003701906](#) [0050291907](#) [LY20-4P-DT1-P1E-BR](#) [02.125.8002.8](#)  
[609-3404](#) [61062-3](#) [622-0430](#) [622-3653LF](#) [63453-116](#) [636-1030](#) [636-1427](#) [636-3427](#) [636-4007](#) [641938-9](#) [641991-4](#) [644827-2](#) [65817-010LF](#)  
[65817-015LF](#) [65863-015LF](#) [66207-023LF](#) [67095-007LF](#) [67601157](#) [68648-049](#) [70.362.1628.0](#) [70-4210](#) [70-4226B](#) [70-4853B](#) [707-5020](#) [707-](#)  
[5028](#) [71.350.2428.0](#) [71918-208LF](#) [71961-016LF](#) [733-134](#) [733-162](#) [754199-000](#) [760-3052](#) [787-8014-00](#) [79531-3000](#) [FCN-360C032-B](#) [FCN-](#)  
[367T-T012/H](#) [FCN-723D010/2](#) [80.063.4001.1](#) [800-90-001-10-001000](#) [800-90-010-10-002000](#) [801-43-002-10-013000](#) [801-43-006-10-002000](#)