

DRAWING FOR REFERENCE: This is subject to change without notice  
08/11/2012

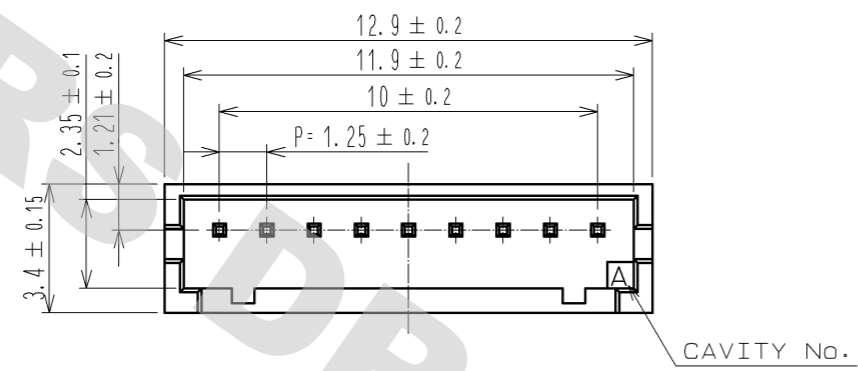

CAVITY No.

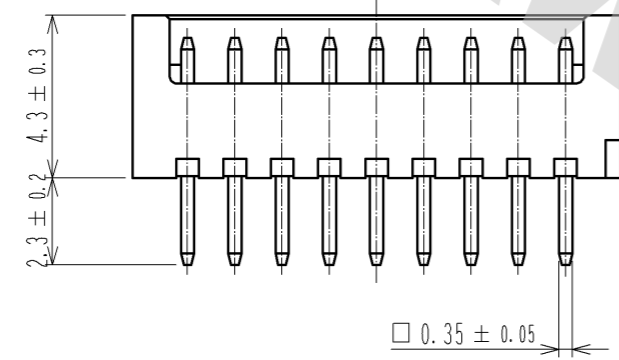

POLARIZATION MARKING

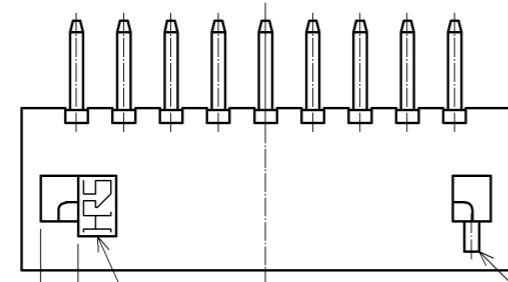
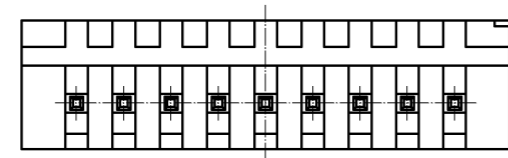

(1) HRS MARKING

POLARIZATION MARKING

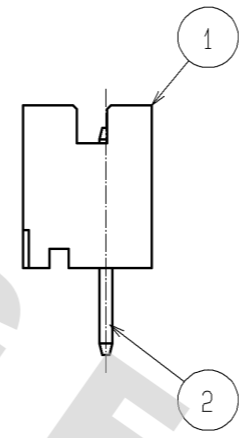

1 APPLICATION FIGURE

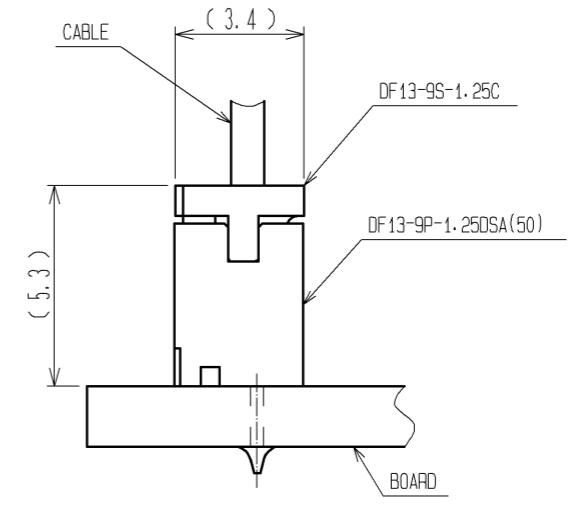

RECOMMENDED PATTERN (BOARD THICKNESS 1mm)

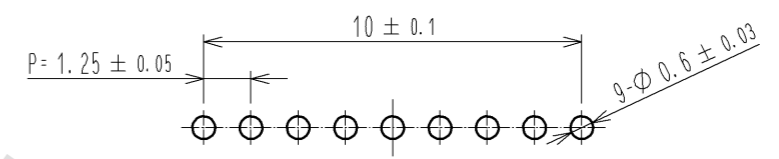

NOTE 1 WHEN THIS CONNECTOR MATES WITH DF13-9S-1.25C, THE MATING LENGTH IS 5.3mm.

2	BRASS	SURFACE:GOLD PLATED 0.2µm min UNDER PLATING:NICKEL PLATED 0.5µm min	4	STYRENIC-BASED ELASTOMERS	STOPPER, GREEN			
1	POLYAMIDE	BEIGE (NATURAL), UL94V-0	3	PS	ELECTROSTATIC PROTECTION, CLEAR			
NO.	MATERIAL	FINISH, REMARKS	NO.	MATERIAL	FINISH, REMARKS			
UNITS mm		SCALE 5 : 1		COUNT	DESCRIPTION OF REVISIONS	DESIGNED	CHECKED	DATE
<b>HRS</b> HIROSE ELECTRIC CO., LTD.		APPROVED : TS. SAKATA	08.09.01	DRAWING NO. EDC3-081808-02				
		CHECKED : TS. KUMAZAWA	08.08.29	PART NO. DF13-9P-1.25DSA(50)				
		DESIGNED : SN. KOBAYASHI	08.08.29	CODE NO. CL536-0108-8-50				
		DRAWN : SN. KOBAYASHI	08.08.29					

DRAWING FOR REFERENCE: This is subject to change without notice  
08/11/2012

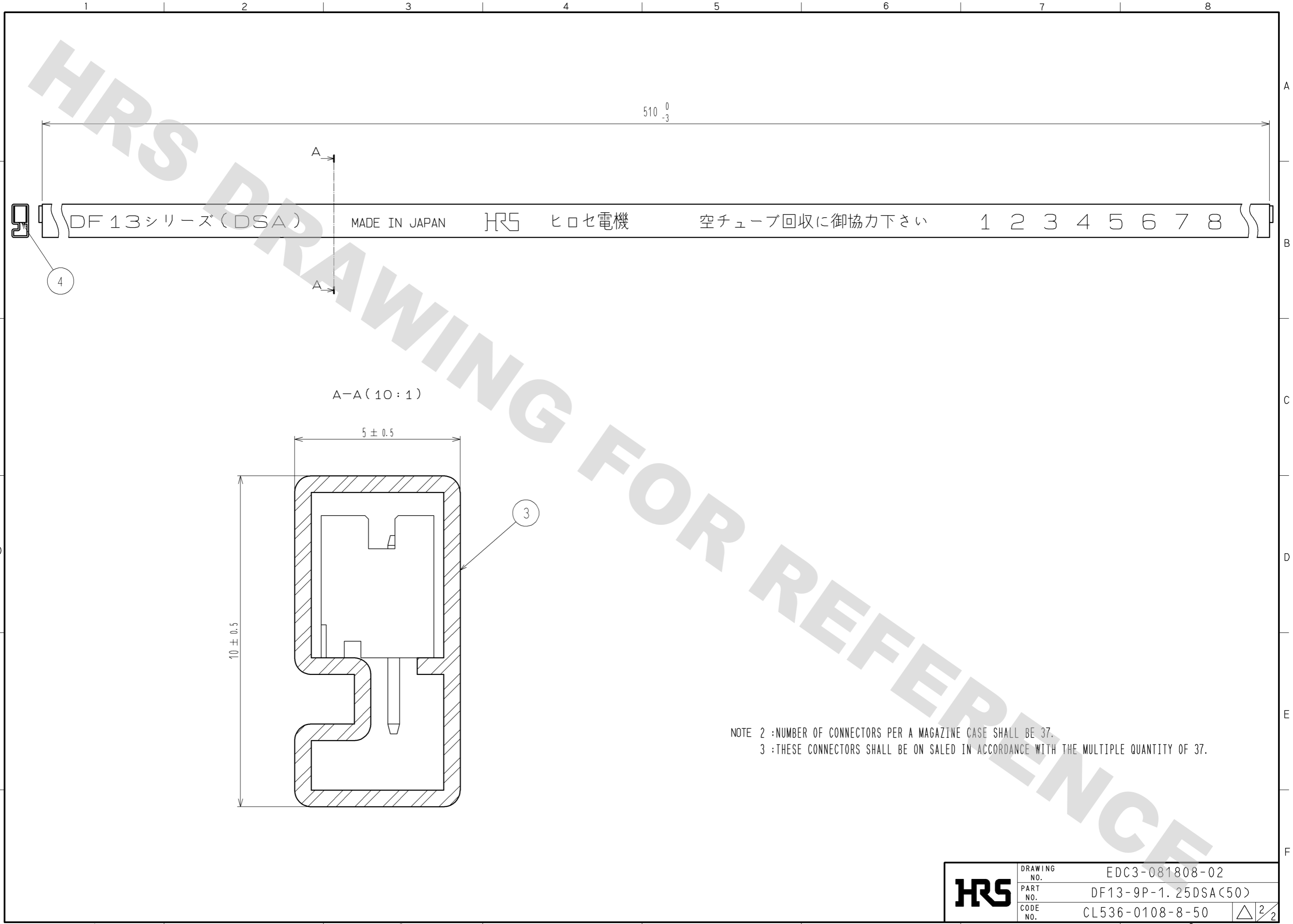

NOTE 2 : NUMBER OF CONNECTORS PER A MAGAZINE CASE SHALL BE 37.  
3 : THESE CONNECTORS SHALL BE ON SALED IN ACCORDANCE WITH THE MULTIPLE QUANTITY OF 37.

<b>HRS</b>	DRAWING NO.	EDC3-081808-02
	PART NO.	DF13-9P-1.25DSA(50)
	CODE NO.	CL536-0108-8-50
		△ 2/2

## X-ON Electronics

Largest Supplier of Electrical and Electronic Components

*Click to view similar products for [Headers & Wire Housings](#) category:*

*Click to view products by [Hirose](#) manufacturer:*

Other Similar products are found below :

[892-18-020-10-001101](#) [58102-G61-06LF](#) [582553-1](#) [0009485154](#) [009176003701906](#) [0050291907](#) [LY20-4P-DT1-P1E-BR](#) [02.125.8002.8](#)  
[609-3404](#) [61062-3](#) [622-0430](#) [622-3653LF](#) [63453-116](#) [636-1030](#) [636-1427](#) [636-3427](#) [636-4007](#) [641938-9](#) [641991-4](#) [644827-2](#) [65817-010LF](#)  
[65817-015LF](#) [65863-015LF](#) [66207-023LF](#) [67095-007LF](#) [67601157](#) [68648-049](#) [70.362.1628.0](#) [70-4210](#) [70-4226B](#) [70-4853B](#) [707-5020](#) [707-](#)  
[5028](#) [71.350.2428.0](#) [71918-208LF](#) [71961-016LF](#) [733-134](#) [733-162](#) [754199-000](#) [760-3052](#) [787-8014-00](#) [79531-3000](#) [FCN-360C032-B](#) [FCN-](#)  
[367T-T012/H](#) [FCN-723D010/2](#) [80.063.4001.1](#) [800-90-001-10-001000](#) [800-90-010-10-002000](#) [801-43-002-10-013000](#) [801-43-006-10-002000](#)