

2.5mm Pitch Connector for Discrete Wire Connection

DF1 Series

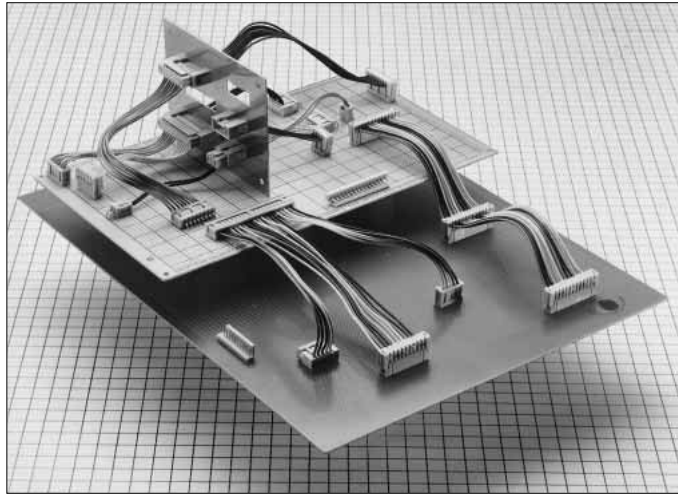

■ Features

1. Board Mounting Height (Crimping Type)

10mm 2.5mm pitch connector achieves the low profile.

2. Insulation Displacement Area Protected by Protector (ID Type)

The connector is structured to protect the insulation displacement connection area by the protector. Therefore, the connector has a strong tensile strength against the cable and prevents dusts.

3. Easy Connection by Easy Tool (ID Type)

No expensive insulation displacement machine is needed. The connection can be established only by mating the cable into the protector and fastening it with the ID tool.

4. Intermediate Connection Possible (ID Type)

For intermediate connection, the connector allows signal extraction during cabling.

[Intermediate Connection]

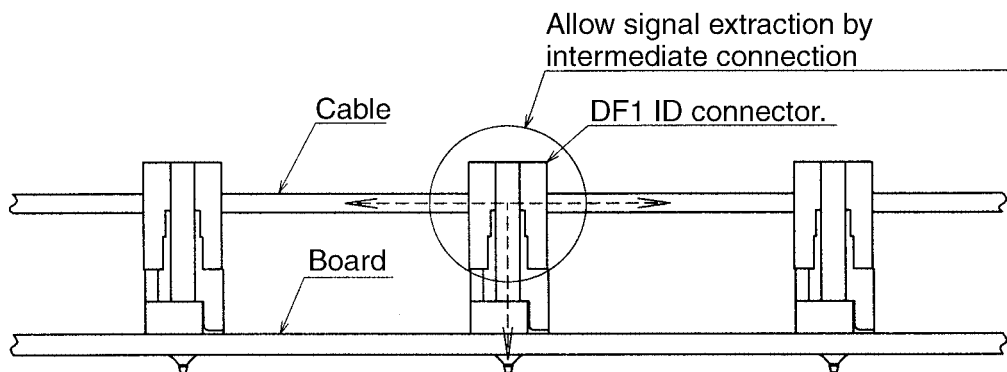

■ Applications

FA equipment, measurement equipment

Product Specifications

Rating	Current rating (Note1)	Cable Size	AWG 24 : 3A AWG 26 : 2A AWG 28 : 1A	Operating Temperature Range	-30 to +85°C (Note2)
	Voltage rating	250V AC		Operating Moisture Range	40 to 80%
				Storage Temperature Range	-10 to +60°C (Note3)
				Storage Moisture Range	40 to 70% (Note3)

Item	Specification	Condition
1. Insulation Resistance	1000M ohms Min	500V DC
2. Withstanding voltage	No flashover or insulation breakdown.	650V AC/1 minute
3. Contact Resistance	30m ohms Max	100mA
4. Insertor/Extraction Force	MIN0.56N (57gf), MAX4.4N(450gf)	Measure by the square steel pin with 0.635±0.002mm
5. Vibration	No electrical discontinuity of 1μs or more	Frequency: 10 to 55 Hz, single amplitude of 0.75 mm, 2 hours in each of the 3 directions.
6. Moisture Resistance	Contact resistance: 30m ohms Max Insulation resistance: 1000M ohms Min	96 hours at temperature of 40°C and humidity of 90% to 95%
7. Temperature Cycle	Contact resistance: 30m ohms max. Insulation resistance: 1000M ohms min.	(-55°C: 30 minutes → 5~35°C: 10 minutes → 85°C: 30 minutes → 5~35°C: 10 minutes) 5 cycles
8. Durability (Mating/un-mating)	Contact resistance: 30m ohms max.	Tin plating: 30 cycles
9. Resistance to Soldering heat	No deformation of components affecting performance.	Flow: 250°C for 10 seconds Manual soldering: 300°C for 3 seconds

Note 1: The rated current will be changed according to cable sizes for use. For the header only, the rating is 3A.

Note 2: Includes temperature rise caused by current flow.

Note 3: The term "storage" refers to products stored for long period of time prior to mounting and use. Operating Temperature Range and Humidity range covers non conducting condition of installed connectors in storage, shipment or during transportation.

Note 4: Information contained in this catalog represents general requirements for this Series. Contact us for the drawings and specifications for a specific part number shown.

Material

Product	Part	Material	Finish	Remarks
Crimping Socket	Insulator	Polyamide	Light Brown	UL94V-0
Crimping Contact	Contact	Phosphor copper	Tin plated	—
ID Socket	Insulator	Polyamide	Light Brown	UL94V-0
	Contact	Phosphor copper	Tin plated	—
Pin Header	Insulator	Polyamide	Light Brown	UL94V-0
	Contact	Phosphor copper	Tin plated	—

Note: Hirose's tin-plated products takes measures against whisker.

Ordering Information

Connector

DF1 - * **S** - **2.5** **C**

① ② ③ ④ ⑤

① Series Name : DF1	⑤ Contact Type C : Crimping socket R24 : AWG24 ID socket R26 : AWG26 ID socket R28 : AWG28 ID socket DSA : Straight through hole DS : Right angle through hole
② Number of Contact : 2 to 16, 20	
③ Connector Type S: Socket P: Pin Header	
④ Contact Pitch : 2.5mm	

Protector

DF1 - * **A** **1.05**

① ② ③

① Number of Contact : 2 to 16, 20	③ Cable Clamp Size 1.05: UL1007 AWG26, 28 1.33: UL1007 AWG24
② Connector Type A: Discrete wire	

Contact

DF1 - **2428SCF**

① ②

① Applicable Cable Size 2428: AWG 24 to 28	② Packaging Type SCF : Socket contact, reel packaging / Tin plated SC : Socket contact, bag packaging / Tin plated
---	--

ID Socket (Open End Type)

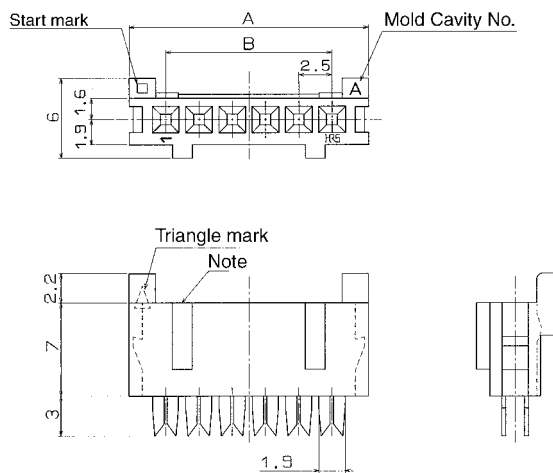

Note: This convex portion is located (2 contacts: the center at one point)(3 to 6 contacts: as shown in the illustration)(more than 7 contacts: one center at one point added to the above illustration).

●Applicable Cable

Part Number	Applicable Cable	Jacket Diameter
DF1-*S-2.5R24(05)	UL1007 AWG24(11 pieces/0.16mm)	1.35 to 1.45mm
DF1-*S-2.5R26(05)	UL1007 AWG26(7 pieces/0.16mm)	1.25 to 1.35mm
DF1-*S-2.5R28(05)	UL1007 AWG28(7 pieces/0.127mm)	1.15 to 1.25mm

(Tin plated annealing copper wire)

●AWG24 Cable Socket Size (Triangle Mark: Green)

Unit: mm

Part Number	CL No.	Number of Contacts	A	B	RoHS	Part Number	CL No.	Number of Contacts	A	B	RoHS
DF1-2S-2.5R24(05)	541-0039-2-05	2	8	2.5	Yes	DF1-10S-2.5R24(05)	541-0047-0-05	10	28	22.5	Yes
DF1-3S-2.5R24(05)	541-0040-1-05	3	10.5	5		DF1-11S-2.5R24(05)	541-0048-3-05	11	30.5	25	
DF1-4S-2.5R24(05)	541-0041-4-05	4	13	7.5		DF1-12S-2.5R24(05)	541-0049-6-05	12	33	27.5	
DF1-5S-2.5R24(05)	541-0042-7-05	5	15.5	10		DF1-13S-2.5R24(05)	541-0050-5-05	13	35.5	30	
DF1-6S-2.5R24(05)	541-0043-0-05	6	18	12.5		DF1-14S-2.5R24(05)	541-0051-8-05	14	38	32.5	
DF1-7S-2.5R24(05)	541-0044-2-05	7	20.5	15		DF1-15S-2.5R24(05)	541-0052-0-05	15	40.5	35	
DF1-8S-2.5R24(05)	541-0045-5-05	8	23	17.5		DF1-16S-2.5R24(05)	541-0053-3-05	16	43	37.5	
DF1-9S-2.5R24(05)	541-0046-8-05	9	25.5	20		DF1-20S-2.5R24(05)	541-0057-4-05	20	53	47.5	

●AWG26 Cable Socket Size (Triangle Mark: Light Blue)

Unit: mm

Part Number	CL No.	Number of Contacts	A	B	RoHS	Part Number	CL No.	Number of Contacts	A	B	RoHS
DF1-2S-2.5R26(05)	541-0058-7-05	2	8	2.5	Yes	DF1-10S-2.5R26(05)	541-0066-5-05	10	28	22.5	Yes
DF1-3S-2.5R26(05)	541-0059-0-05	3	10.5	5		DF1-11S-2.5R26(05)	541-0067-8-05	11	30.5	25	
DF1-4S-2.5R26(05)	541-0060-9-05	4	13	7.5		DF1-12S-2.5R26(05)	541-0068-0-05	12	33	27.5	
DF1-5S-2.5R26(05)	541-0061-1-05	5	15.5	10		DF1-13S-2.5R26(05)	541-0069-3-05	13	35.5	30	
DF1-6S-2.5R26(05)	541-0062-4-05	6	18	12.5		DF1-14S-2.5R26(05)	541-0070-2-05	14	38	32.5	
DF1-7S-2.5R26(05)	541-0063-7-05	7	20.5	15		DF1-15S-2.5R26(05)	541-0071-5-05	15	40.5	35	
DF1-8S-2.5R26(05)	541-0064-0-05	8	23	17.5		DF1-16S-2.5R26(05)	541-0072-8-05	16	43	37.5	
DF1-9S-2.5R26(05)	541-0065-2-05	9	25.5	20		DF1-20S-2.5R26(05)	541-0076-9-05	20	53	47.5	

●AWG28 Cable Socket Size (Triangle Mark: Red)

Unit: mm

Part Number	CL No.	Number of Contacts	A	B	RoHS	Part Number	CL No.	Number of Contacts	A	B	RoHS
DF1-2S-2.5R28(05)	541-0115-9-05	2	8	2.5	Yes	DF1-10S-2.5R28(05)	541-0123-7-05	10	28	22.5	Yes
DF1-3S-2.5R28(05)	541-0116-1-05	3	10.5	5		DF1-11S-2.5R28(05)	541-0124-0-05	11	30.5	25	
DF1-4S-2.5R28(05)	541-0117-4-05	4	13	7.5		DF1-12S-2.5R28(05)	541-0125-2-05	12	33	27.5	
DF1-5S-2.5R28(05)	541-0118-7-05	5	15.5	10		DF1-13S-2.5R28(05)	541-0126-5-05	13	35.5	30	
DF1-6S-2.5R28(05)	541-0119-0-05	6	18	12.5		DF1-14S-2.5R28(05)	541-0127-8-05	14	38	32.5	
DF1-7S-2.5R28(05)	541-0120-9-05	7	20.5	15		DF1-15S-2.5R28(05)	541-0128-0-05	15	40.5	35	
DF1-8S-2.5R28(05)	541-0121-1-05	8	23	17.5		DF1-16S-2.5R28(05)	541-0129-3-05	16	43	37.5	
DF1-9S-2.5R28(05)	541-0122-4-05	9	25.5	20		DF1-20S-2.5R28(05)	531-0133-0-05	20	53	47.5	

Note: A packaging quantity is delivered by the bag unit (100 pcs.). If needed, please order the products per bag.

Protector

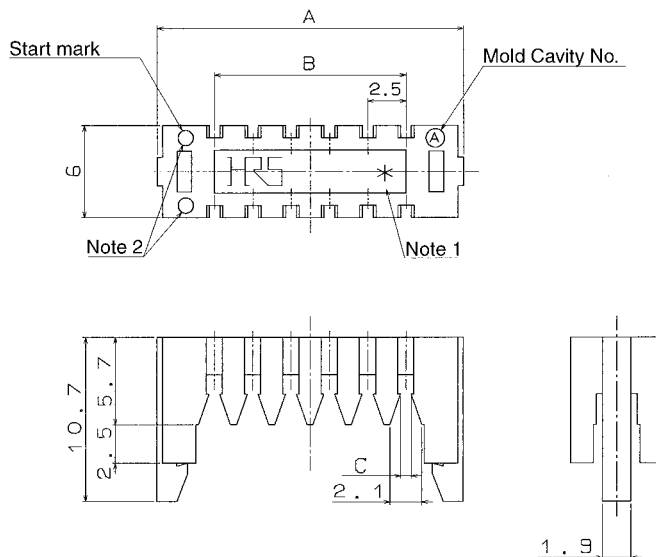
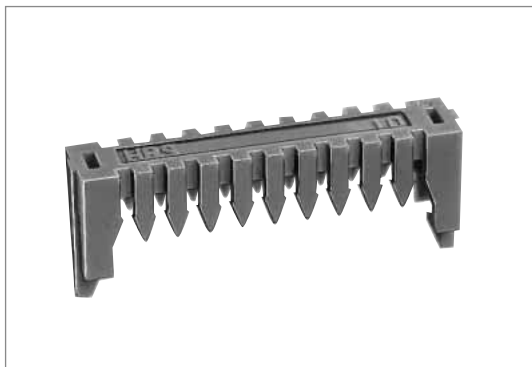

Note 1. Product contact No. mark, however 2 and 3 contacts are not indicated.
 Note 2. Round hole to distinguish the protector A1.05 and 1.33 (DF1- *A1.05 only)

Select the protector after inspecting the cable jacket diameter for use.

Protector Type	Applicable Jacket Diameter	Recommended Cable
DF1- *A1.33	φ1.35 to φ1.45	UL1007 AWG24
DF1- *A1.05	φ1.1 to φ1.35	UL1007 AWG26 28

*indicates contact No.

●AWG24 Cable Protector Size

Unit: mm

Part Number	CL No.	Number of Contacts	A	B	C	RoHS
DF1- 2A1.33	541-0077-1	2	10	2.5	1.1	Yes
DF1- 3A1.33	541-0078-4	3	12.5	5	1.1	
DF1- 4A1.33	541-0079-7	4	15	7.5	1.1	
DF1- 5A1.33	541-0080-6	5	17.5	10	1.1	
DF1- 6A1.33	541-0081-9	6	20	12.5	1.1	
DF1- 7A1.33	541-0082-1	7	22.5	15	1.1	
DF1- 8A1.33	541-0083-4	8	25	17.5	1.1	
DF1- 9A1.33	541-0084-7	9	27.5	20	1.1	
DF1-10A1.33	541-0085-0	10	30	22.5	1.1	
DF1-11A1.33	541-0086-2	11	32.5	25	1.1	
DF1-12A1.33	541-0087-5	12	35	27.5	1.1	
DF1-13A1.33	541-0088-8	13	37.5	30	1.1	
DF1-14A1.33	541-0089-0	14	40	32.5	1.1	
DF1-15A1.33	541-0090-0	15	42.5	35	1.1	
DF1-16A1.33	541-0091-2	16	45	37.5	1.1	
DF1-20A1.33	541-0095-3	20	55	47.5	1.1	

●AWG26, 28 Cable Protector Size

Unit: mm

Part Number	CL No.	Number of Contacts	A	B	C	RoHS
DF1- 2A1.05	541-0096-6	2	10	2.5	0.7	Yes
DF1- 3A1.05	541-0097-9	3	12.5	5	0.7	
DF1- 4A1.05	541-0098-1	4	15	7.5	0.7	
DF1- 5A1.05	541-0099-4	5	17.5	10	0.7	
DF1- 6A1.05	541-0100-1	6	20	12.5	0.7	
DF1- 7A1.05	541-0101-4	7	22.5	15	0.7	
DF1- 8A1.05	541-0102-7	8	25	17.5	0.7	
DF1- 9A1.05	541-0103-0	9	27.5	20	0.7	
DF1-10A1.05	541-0104-2	10	30	22.5	0.7	
DF1-11A1.05	541-0105-5	11	32.5	25	0.7	
DF1-12A1.05	541-0106-8	12	35	27.5	0.7	
DF1-13A1.05	541-0107-0	13	37.5	30	0.7	
DF1-14A1.05	541-0108-3	14	40	32.5	0.7	
DF1-15A1.05	541-0109-6	15	42.5	35	0.7	
DF1-16A1.05	541-0110-5	16	45	37.5	0.7	
DF1-20A1.05	541-0114-6	20	55	47.5	0.7	

Note: A packaging quantity is delivered by the bag unit (100 pcs.). If needed, please order the product per bag.

■Crimping Socket

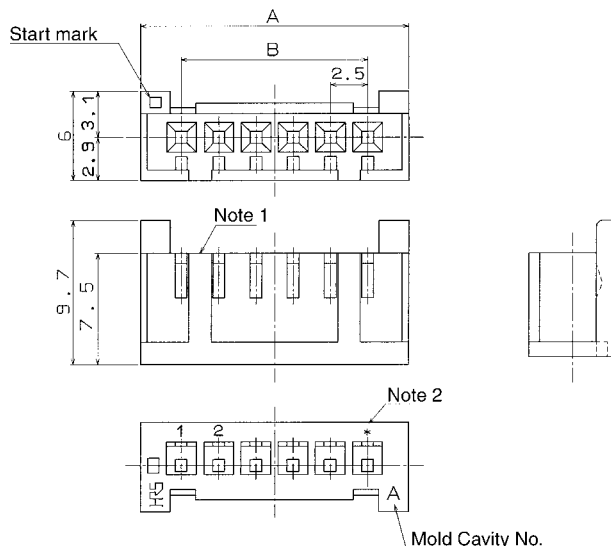
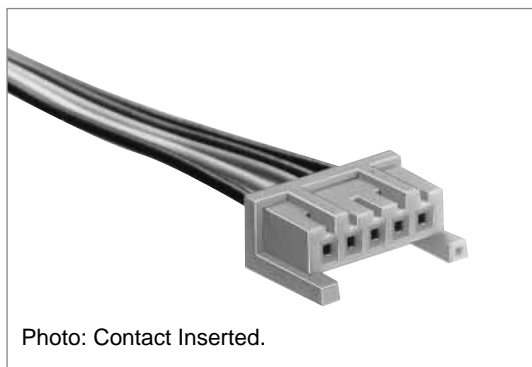

Note1: This convex portion is located (2 contacts: the center at one point)(3 to 6 contacts: as shown in the illustration)(more than 7 contacts: one center at one point added to the above illustration).
 Note 2: The terminal number indicates all contact numbers.

Unit: mm

Part Number	CL No.	Number of Contacts	A	B	RoHS	Part Number	CL No.	Number of Contacts	A	B	RoHS
DF1- 2S-2.5C	541-0136-9	2	8	2.5	Yes	DF1-11S-2.5C	541-0145-0	11	30.5	25	Yes
DF1- 3S-2.5C	541-0137-1	3	10.5	5		DF1-12S-2.5C	541-0146-2	12	33	27.5	
DF1- 4S-2.5C	541-0138-4	4	13	7.5		DF1-13S-2.5C	541-0147-5	13	33.5	30	
DF1- 5S-2.5C	541-0139-7	5	15.5	10		DF1-14S-2.5C	541-0148-8	14	38	32.5	
DF1- 6S-2.5C	541-0140-6	6	18	12.5		DF1-15S-2.5C	541-0149-0	15	40.5	35	
DF1- 7S-2.5C	541-0141-9	7	20.5	15		DF1-16S-2.5C	541-0150-0	16	43	37.5	
DF1- 8S-2.5C	541-0142-1	8	23	17.5		DF1-18S-2.5C	541-0152-5	18	48	42.5	
DF1- 9S-2.5C	541-0143-4	9	25.5	20		DF1-20S-2.5C	541-0154-0	20	53	47.5	
DF1-10S-2.5C	541-0144-7	10	28	22.5							

Note: A packaging quantity is delivered by the bag unit (100 pcs.). If needed, please order the product per bag.

■Crimping Contact for Socket

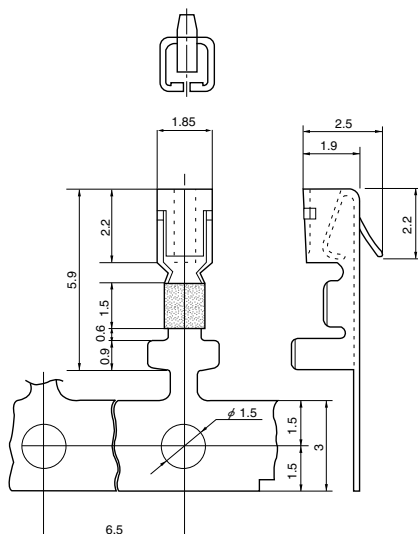

Part Number	CL No.	Packaging Type	Number of Contacts	Finish	RoHS
DF1-2428SCF	541-0134-3	Reel	10000	Tin plating	Yes
DF1-2428SC	541-0135-6	Bag	100		

●Applicable Cable (Tin Plated Annealing Copper Wire)

Conductor Size (wire construction)	Jacket Diameter
AWG24 (11 cores/0.16mm)	φ0.9 to φ1.5mm
AWG26 (7 cores/0.16mm)	
AWG28 (07 cores/1.24mm)	

Note: If other cables are used instead of the applicable cable, contact Hirose sales department.

●Recommended Cable

UL1061, UL1007

●Strip Length

1.9 to 2.4mm

◆Applicable Crimping Tool

Type	Part Number	CL No.	Applicable Contact
Applicator	AP105-DF1-2428S	901-4538-8	DF1-2428SCF
Press Main Unit	CM-105	901-0005-4	_____
Manual Crimping Tool	DF1-T2428S	550-0102-8	DF1-2428SC
Extraction Tool	Flat-bladed screwdriver, 0.75 mm max, blade width.		

Note 1: If a trouble has occurred due to tools which are not designated by Hirose, Hirose won't guarantee any product.

Note 2: Refer to technical specification for work method of extraction tool.

Pin Header Right Angle Type



● Board Through-hole Diameter : $\phi 1.1^{+0.1}$

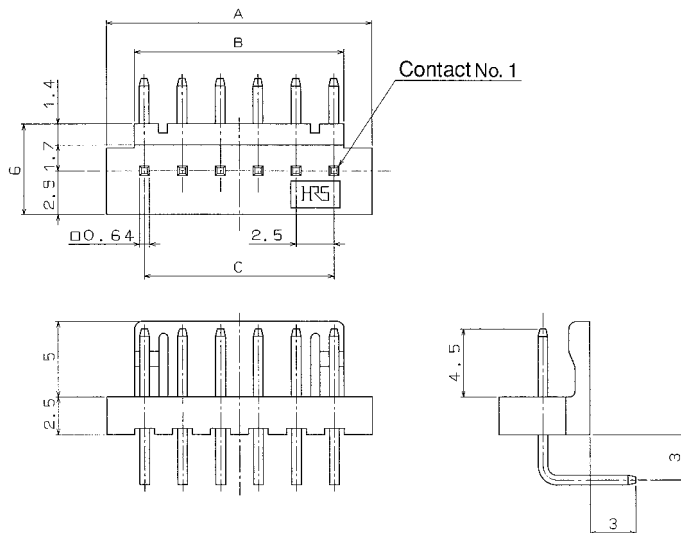

Unit: mm

Part Number	CL No.	Number of Contacts	A	B	C	RoHS
DF1- 2P-2.5DS(05)	541-0020-4-05	2	7.5	3.8	2.5	Yes
DF1- 3P-2.5DS(05)	541-0021-7-05	3	10	6.3	5	
DF1- 4P-2.5DS(05)	541-0022-0-05	4	12.5	8.8	7.5	
DF1- 5P-2.5DS(05)	541-0023-2-05	5	15	11.3	10	
DF1- 6P-2.5DS(05)	541-0024-5-05	6	17.5	13.8	12.5	
DF1- 7P-2.5DS(05)	541-0025-8-05	7	20	16.3	15	
DF1- 8P-2.5DS(05)	541-0026-0-05	8	22.5	18.8	17.5	
DF1- 9P-2.5DS(05)	541-0027-3-05	9	25	21.3	20	
DF1- 10P-2.5DS(05)	541-0028-6-05	10	27.5	23.8	22.5	

Part Number	CL No.	Number of Contacts	A	B	C	RoHS
DF1-11P-2.5DS(05)	541-0029-9-05	11	30	26.3	25	Yes
DF1-12P-2.5DS(05)	541-0030-8-05	12	32.5	28.8	27.5	
DF1-13P-2.5DS(05)	541-0031-0-05	13	35	31.3	30	
DF1-14P-2.5DS(05)	541-0032-3-05	14	37.5	33.8	32.5	
DF1-15P-2.5DS(05)	541-0033-6-05	15	40	36.3	35	
DF1-16P-2.5DS(05)	541-0034-9-05	16	42.5	38.8	37.5	
DF1-18P-2.5DS(05)	541-0036-4-05	18	47.5	43.8	42.5	
DF1-20P-2.5DS(05)	541-0038-0-05	20	52.5	48.8	47.5	

Note 1. A packaging quantity is delivered by the bag unit (100 pcs.). If needed, please order the product per bag.

Note 2. The socket applicable to the 18 contact connector is only crimping type.

Pin Header Straight Type

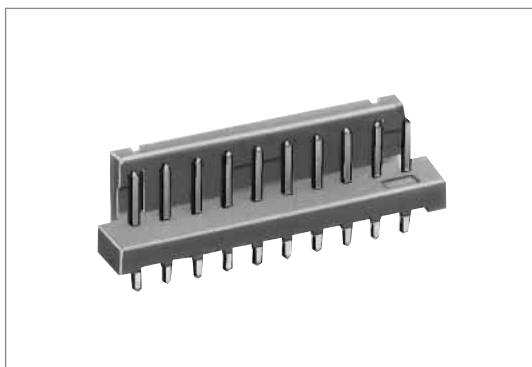

● Board Through-hole Diameter : $\phi 1.1^{+0.1}$

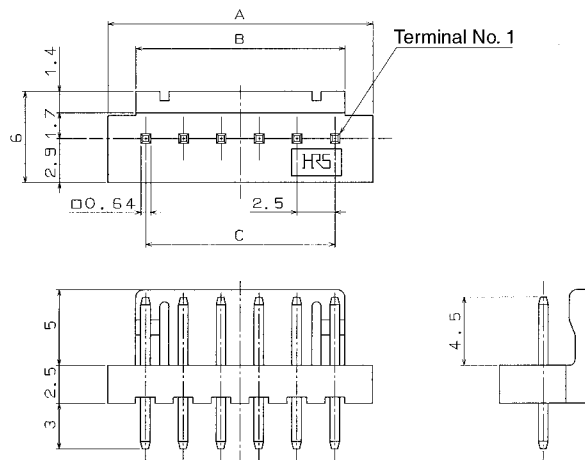

Unit: mm

Part Number	CL No.	Number of Contacts	A	B	C	RoHS
DF1- 2P-2.5DSA(05)	541-0001-0-05	2	7.5	3.8	2.5	Yes
DF1- 3P-2.5DSA(05)	541-0002-2-05	3	10	6.3	5	
DF1- 4P-2.5DSA(05)	541-0003-5-05	4	12.5	8.8	7.5	
DF1- 5P-2.5DSA(05)	541-0004-8-05	5	15	11.3	10	
DF1- 6P-2.5DSA(05)	541-0005-0-05	6	17.5	13.8	12.5	
DF1- 7P-2.5DSA(05)	541-0006-3-05	7	20	16.3	15	
DF1- 8P-2.5DSA(05)	541-0007-6-05	8	22.5	18.8	17.5	
DF1- 9P-2.5DSA(05)	541-0008-9-05	9	25	21.3	20	
DF1- 10P-2.5DSA(05)	541-0009-1-05	10	27.5	23.8	22.5	

Part Number	CL No.	Number of Contacts	A	B	C	RoHS
DF1-11P-2.5DSA(05)	541-0010-0-05	11	30	26.3	25	Yes
DF1-12P-2.5DSA(05)	541-0011-3-05	12	32.5	28.8	27.5	
DF1-13P-2.5DSA(05)	541-0012-6-05	13	35	31.3	30	
DF1-14P-2.5DSA(05)	541-0013-9-05	14	37.5	33.8	32.5	
DF1-15P-2.5DSA(05)	541-0014-1-05	15	40	36.3	35	
DF1-16P-2.5DSA(05)	541-0015-4-05	16	42.5	38.8	37.5	
DF1-18P-2.5DSA(05)	541-0017-0-05	18	47.5	43.8	42.5	
DF1-20P-2.5DSA(05)	541-0019-5-05	20	52.5	48.8	47.5	

Note 1. A packaging quantity is delivered by the bag unit (100 pcs.). If needed, please order the product per bag.

Note 2. The socket applicable to the 18 contacts connector is only crimping type.

◆ DF1 Connection Press

Part Number	CL No.	Height	Width	Depth	Weight
DF1 Connection Press HP513	550-0134-4	200mm	260mm	250mm	3.7kg

Note: The intermediate connection can be established by removing the cable cutting blade of this press machine.

Select a protector after inspecting a cable Jacket diameter for use.

Protector Type	Applicable Jacket Diameter	Recommended Cable
DF1- * A1.33	φ1.35 to φ1.45	UL1007 AWG24
DF1- * A1.05	φ1.1 to φ1.35	UL1007 AWG26, 28

* indicates contact No.



DF1 Connection Press HP513

◆ DF1 Cable Crimper

Part Number	CL No.
DF1 Cable Crimper	550-0130-3

Used to install the cable in the protector.

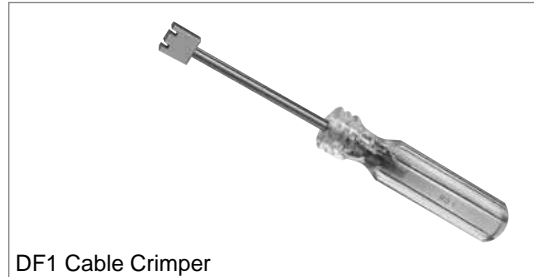

DF1 Cable Crimper

◆ Precautions

1. Recommended Soldering Condition	Flow: 250°C for 10 seconds Manual soldering: 300°C for 3 seconds
2. Cleaning Condition	Refer to Nylon Connector Use Hand book.
3. Connection Condition	[Crimping] Refer to Nylon Connector Use Hand book. [ID] ● For the insulation displacement tool, set a set of connector per insulation displacement. If more than 2 connectors have been set, they interrupt each other, which will cause an insulation displacement failure. ● After the insulation displacement, make sure that the locks on both protector sides are completely activated.
4. Precaution	Slight variations in color of the plastic compounds do not affect form, fit or function of the connector.
5. Precaution	Refer to Nylon Connector Use Hand book.

X-ON Electronics

Largest Supplier of Electrical and Electronic Components

Click to view similar products for [Headers & Wire Housings](#) category:

Click to view products by [Hirose](#) manufacturer:

Other Similar products are found below :

[95000-104TRLF](#) [10135584-644402LF](#) [DF62W-EP2022PCA](#) [95000-106TRLF](#) [DF62W-2022SCA](#) [DF62W-EP2022PC](#) [2203348](#) [DF62W-2022SC](#) [1084018](#) [1029039](#) [1084017](#) [802-10-012-10-002000](#) [1112640](#) [1112639](#) [000-34000](#) [0009482033](#) [0009507031](#) [57102-S06-03LF](#) [57202-S52-04LF](#) [PCN6-15S-2.5E](#) [0039019024](#) [58102-G61-06LF](#) [582553-1](#) [0009485154](#) [0009508121](#) [0022285053](#) [0050291907](#) [018731A](#) [LY20-4P-DT1-P1E-BR](#) [02.125.8002.8](#) [60101931](#) [60598-1 \(Cut Strip\)](#) [M1625-3R/100](#) [61062-3](#) [61082-181009](#) [636-1427](#) [638009-1](#) [641938-9](#) [641991-4](#) [644168-1](#) [647662-1](#) [65039-019ELF](#) [65817-002LF](#) [65817-015LF](#) [65863-015LF](#) [66207-023LF](#) [67016-026LF](#) [67046-001LF](#) [67095-007LF](#) [67230-005LF](#)