

Aug.1.2021 Copyright 2021 HIROSE ELECTRIC CO., LTD. All Rights Reserved.
 In case of consideration for using Automotive equipment / device which demand high reliability, kindly contact our sales window correspondents.

COUNT	DESCRIPTION OF REVISIONS	BY	CHKD	DATE	COUNT	DESCRIPTION OF REVISIONS	BY	CHKD	DATE
△					△				
△					△				
△					△				

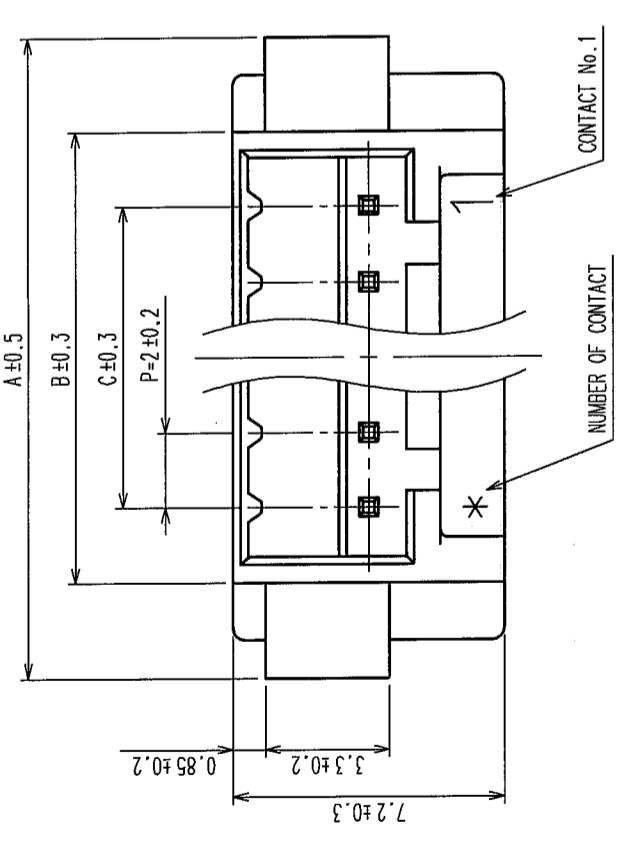

A - A

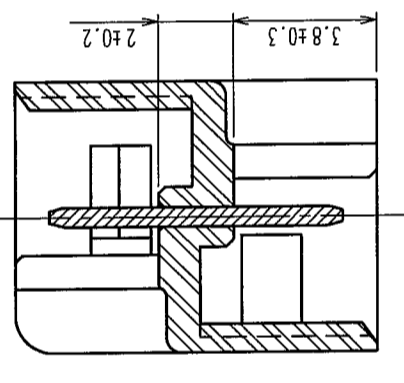

CODE No.	PART No.	CONTACTS	A	B	C	D	E
CL543-0267-0	DF3-2EP-2A	2	11	6	2	9.4	6.3
CL543-0268-2	DF3-3EP-2A	3	13	8	4	11.4	8.3
CL543-0269-5	DF3-4EP-2A	4	15	10	6	13.4	10.3
CL543-0270-4	DF3-5EP-2A	5	17	12	8	15.4	12.3
CL543-0271-7	DF3-6EP-2A	6	19	14	10	17.4	14.3
CL543-0272-0	DF3-7EP-2A	7	21	16	12	19.4	16.3
CL543-0273-2	DF3-8EP-2A	8	23	18	14	21.4	18.3
CL543-0274-5	DF3-9EP-2A	9	25	20	16	23.4	20.3
CL543-0275-8	DF3-10EP-2A	10	27	22	18	25.4	22.3
CL543-0276-0	DF3-11EP-2A	11	29	24	20	27.4	24.3
CL543-0277-3	DF3-12EP-2A	12	31	26	22	29.4	26.3
CL543-0278-6	DF3-13EP-2A	13	33	28	24	31.4	28.3
CL543-0279-9	DF3-14EP-2A	14	35	30	26	33.4	30.3
CL543-0280-8	DF3-15EP-2A	15	37	32	28	35.4	32.3

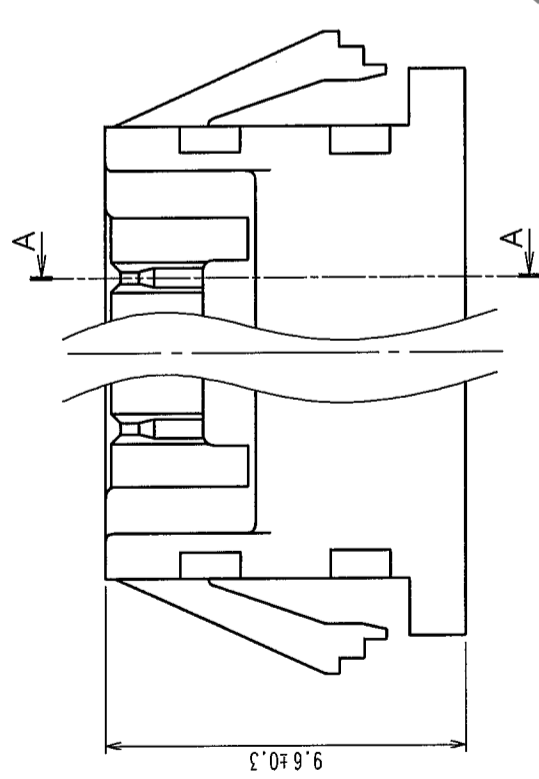

PANEL CUTOFF DIMENSIONS(2:1)

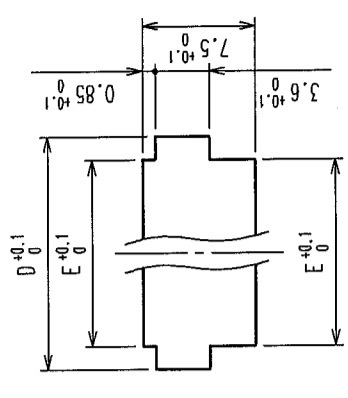
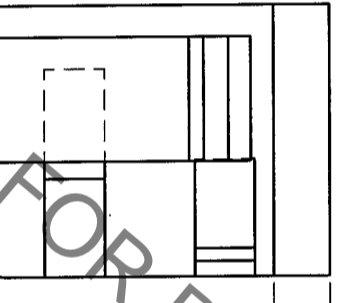
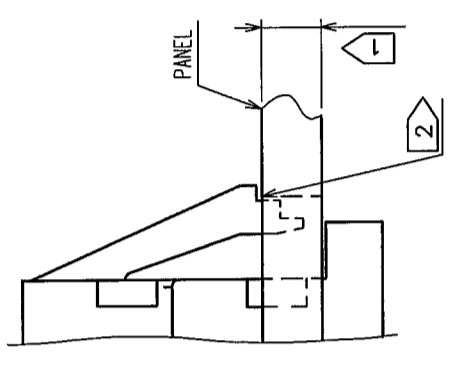

NOTE 1 > APPLICABLE PANEL THICKNESS : 1.6~0.8mm
 (NOTE THAT SOME LOOSENESS IS UNAVOIDABLE WHEN THE PLUGS ARE MOUNTED ON A PANEL OF OTHER THAN 1.6 OR 2.2mm THICKNESS.)
 NOTE 2 > USE THE SHARP EDGE FOR ENGAGEMENT WITH THE PANEL.

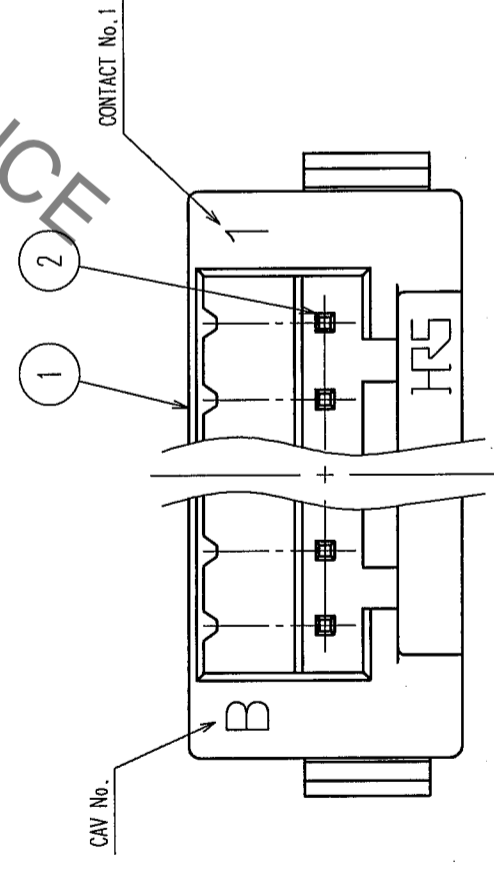

CAV No. CONTACT No. 1

NO.	MATERIAL	FINISH, REMARKS	NO.	MATERIAL	FINISH, REMARKS
1	POLYAMIDE	UL94V-0, BLACK	2	BRASS	SURFACE:TIN PLATING 1μm min UNDER PLATING:NICKEL PLATED 0.5μm min

CODE NO. (OLD)	CL	DRAWN	DESIGNED	CHECKED	APPROVED	RELEASED
		J. Sanyouji	S. Sanyouji	T. Miyagaki	T. Oka	
		04.03.08	04.03.08	04.03.08	04.03.09	

DRAWING NO.	EDC3-306189-01	PART NO.	DF3-*EP-2A
SCALE	5:1	CODE NO.	CL543-
UNITS	ITEM		

HIROSE ELECTRIC CO., LTD.
 FORM NO. 229

X-ON Electronics

Largest Supplier of Electrical and Electronic Components

Click to view similar products for [Headers & Wire Housings](#) category:

Click to view products by [Hirose](#) manufacturer:

Other Similar products are found below :

[892-18-020-10-001101](#) [58102-G61-06LF](#) [582553-1](#) [0009485154](#) [009176003701906](#) [0050291907](#) [LY20-4P-DT1-P1E-BR](#) [02.125.8002.8](#)
[609-3404](#) [61062-3](#) [622-0430](#) [622-3653LF](#) [63453-116](#) [636-1030](#) [636-1427](#) [636-3427](#) [636-4007](#) [641938-9](#) [641991-4](#) [644827-2](#) [65817-010LF](#)
[65817-015LF](#) [65863-015LF](#) [66207-023LF](#) [67095-007LF](#) [67601157](#) [68648-049](#) [70.362.1628.0](#) [70-4210](#) [70-4226B](#) [70-4853B](#) [707-5020](#) [707-5028](#) [71.350.2428.0](#) [71918-208LF](#) [71961-016LF](#) [733-134](#) [733-162](#) [754199-000](#) [760-3052](#) [787-8014-00](#) [79531-3000](#) [FCN-360C032-B](#) [FCN-367T-T012/H](#) [FCN-723D010/2](#) [80.063.4001.1](#) [800-90-001-10-001000](#) [800-90-010-10-002000](#) [801-43-002-10-013000](#) [801-43-006-10-002000](#)