

Sep.1.2021 Copyright 2021 HIROSE ELECTRIC CO., LTD. All Rights Reserved.
In case of consideration for using Automotive equipment / device which demand high reliability, kindly contact our sales window correspondents.

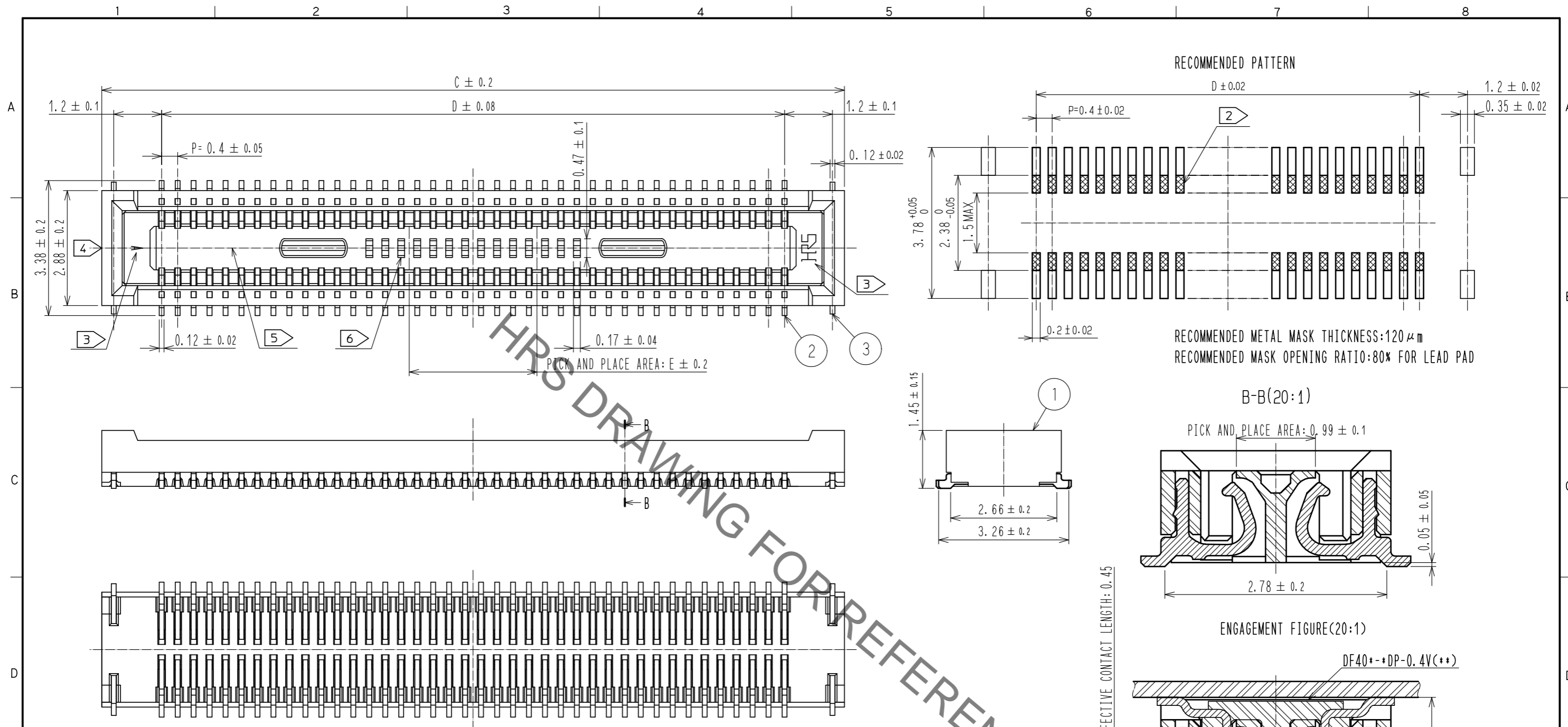

- NOTES) 1. ALL LEADS AND REINFORCED METAL FITTINGS CO-PLANARITY SHALL BE 0.1mm MAX.
 2. IS NO PATTERN AREA OTHER THAN THE SAME CIRCUIT.
 3. HRS MARK AND CAV NO. IS INDICATED IN APPROXIMAL POSITION SHOWN.
 4. GATE POSITION OF 10 TO 50 POSITIONS IS POSITIONED IN APPROXIMAL AREA SHOWN.
 5. GATE POSITION OF 60 TO 100 POSITIONS IS POSITIONED IN APPROXIMAL AREA SHOWN.
 A PART OF THE WALL COULD BE NOTCHED FOR SETTING GATE.
 6. 60 TO 100 POSITIONS HAVE CONCAVE PORTION.

| 製品名 | 製品コード | C | D | E |
|----------------------|-----------------|------|------|-----|
| DF40B-10DS-0.4V(51) | CL684-4038-8-51 | 4.6 | 1.6 | 1.0 |
| DF40B-12DS-0.4V(51) | CL684-4152-3-51 | 5.0 | 2.0 | 1.0 |
| DF40B-20DS-0.4V(51) | — | 6.6 | 3.6 | 1.0 |
| DF40B-24DS-0.4V(51) | — | 7.4 | 4.4 | 1.0 |
| DF40B-30DS-0.4V(51) | CL684-4090-8-51 | 8.6 | 5.6 | 1.5 |
| DF40B-40DS-0.4V(51) | — | 10.6 | 7.6 | 3.2 |
| DF40B-50DS-0.4V(51) | CL684-4018-0-51 | 12.6 | 9.6 | 3.2 |
| DF40B-60DS-0.4V(51) | CL684-4049-4-51 | 14.6 | 11.6 | 3.2 |
| DF40B-80DS-0.4V(51) | CL684-4052-9-51 | 18.6 | 15.6 | 3.2 |
| DF40B-100DS-0.4V(51) | — | 22.6 | 19.6 | 3.2 |

| NO. | MATERIAL | FINISH . REMARKS | NO. | MATERIAL | FINISH . REMARKS |
|-----|-----------------|---|-----|-----------------|--|
| 2 | PHOSPHOR BRONZE | CONTACT AREA:GOLD 0.05μm MIN SMT LEAD:GOLD 0.05μm MIN UNDERPLATING:NICKEL 1μm MIN | 7 | PS | CLEAR, REINFORCEMENT COLLAR |
| 1 | LCP | BLACK, UL94V-0 | 6 | PS | BLACK |
| | | | 5 | POLYESTER | CLEAR, COVER TAPE |
| | | | 4 | PS | CLEAR, EMBOSSED CARRIER TAPE |
| | | | 3 | PHOSPHOR BRONZE | GOLD 0.05μm MIN UNDERPLATING:NICKEL 1μm MIN |

| UNITS | SCALE | COUNT | DESCRIPTION OF REVISIONS | DESIGNED | CHECKED | DATE |
|-------|--------|-------|--------------------------|------------|--------------|------------|
| mm | 10 : 1 | 2 | DIS-H-00002752 | SH. HOSODA | TS. MIYAZAKI | 17. 10. 10 |

| APPROVED | CHECED | DESIGNED | DRAWN | DRAWING NO. | PART NO. | CODE NO. |
|-------------|-----------------|--------------|--------------|----------------|--------------------|----------|
| : KH. IKEDA | : AR. TAKAHASHI | : TK. SUZUKI | : TK. SUZUKI | EDC3-316871-01 | DF40B-*DS-0.4V(51) | CL684 |
| 07. 08. 31 | 07. 08. 31 | 07. 08. 31 | 07. 08. 31 | | | |

Sep.1.2021 Copyright 2021 HIROSE ELECTRIC CO., LTD. All Rights Reserved.
In case of consideration for using Automotive equipment / device which demand high reliability, kindly contact our sales window correspondents.

EMBOSSED CARRIER TAPE PACKAGING (5:1)

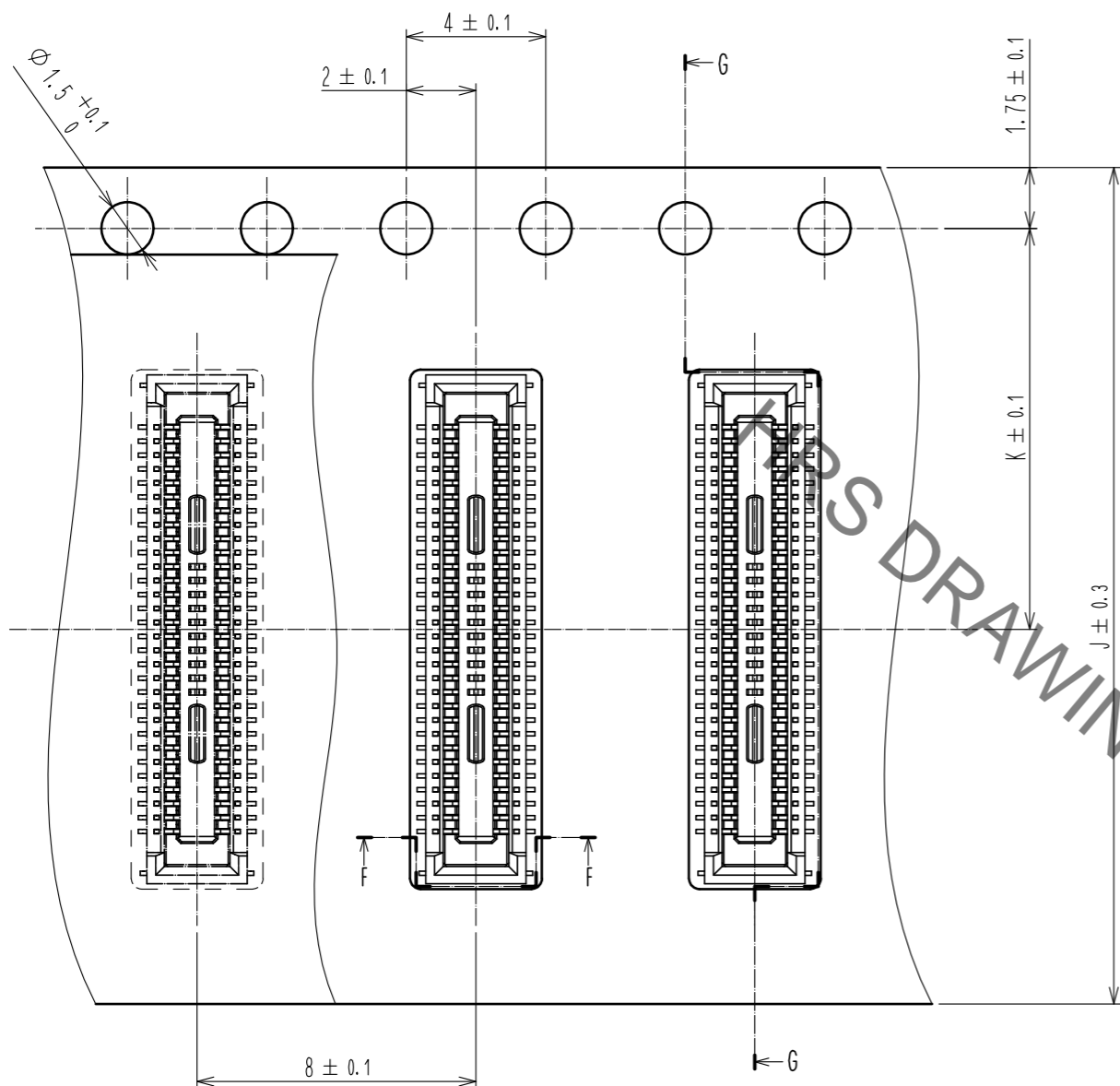

DIRECTION OF UNREELING →

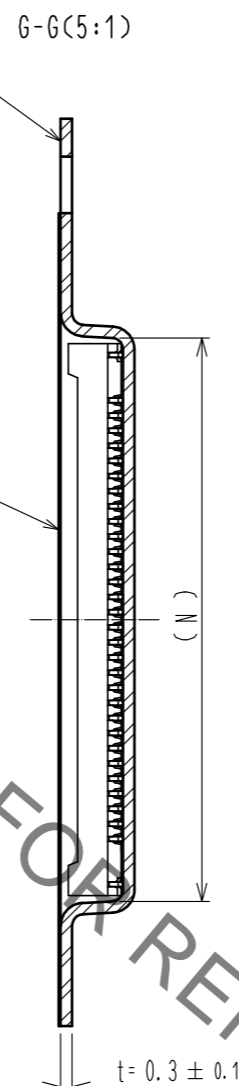
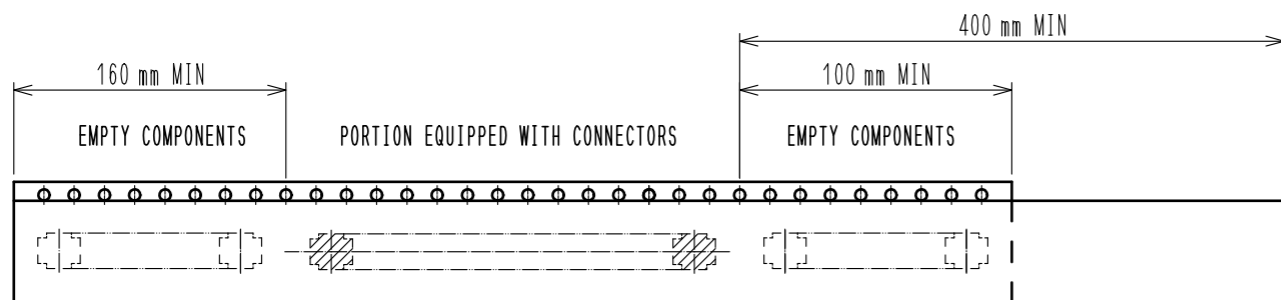
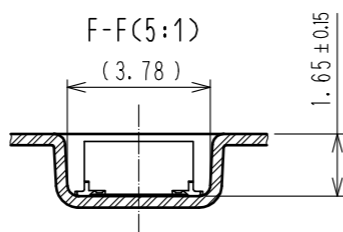

STYLE AND DIMENSION OF REEL(FREE)

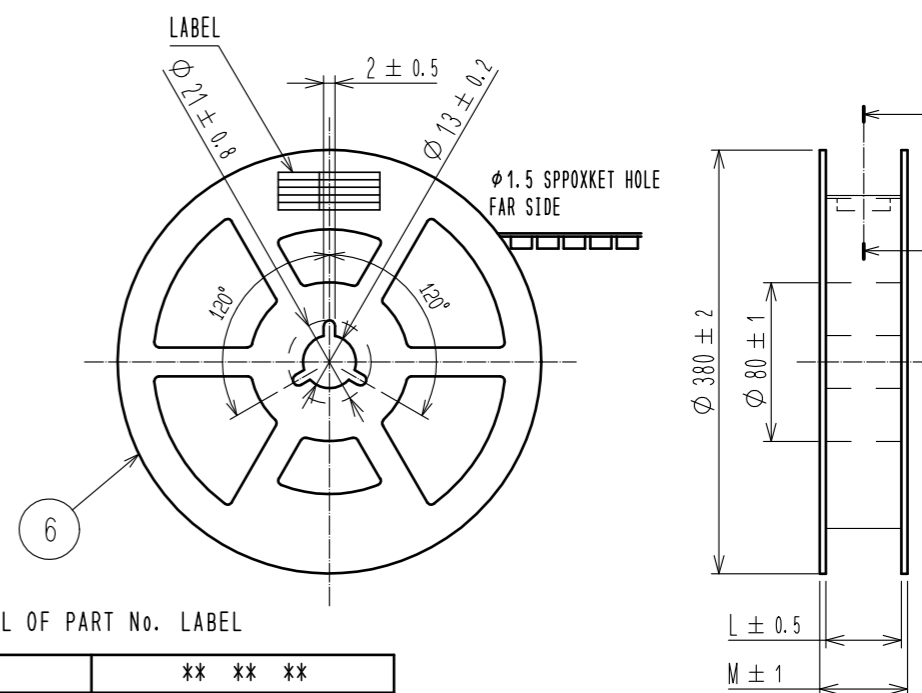

10) DETAIL OF PART No. LABEL

| | |
|-------|--------------------|
| 製造年月日 | ** ** * |
| 製品コード | CL684-*****-51 |
| 製品名 | DF40B-*DS-0.4V(51) |
| 数量 | 5000 |
| 納入者 | ヒロセ電機(株) |

| 製品名 | J | K | L | M | N |
|----------------------|----|------|------|------|------|
| DF40B-10DS-0.4V(51) | 16 | 7.5 | 17.5 | 21.5 | 2.9 |
| DF40B-12DS-0.4V(51) | 16 | 7.5 | 17.5 | 21.5 | 3.3 |
| DF40B-20DS-0.4V(51) | 16 | 7.5 | 17.5 | 21.5 | 4.9 |
| DF40B-24DS-0.4V(51) | 16 | 7.5 | 17.5 | 21.5 | 6.9 |
| DF40B-30DS-0.4V(51) | 24 | 11.5 | 25.5 | 29.5 | 8.9 |
| DF40B-40DS-0.4V(51) | 24 | 11.5 | 25.5 | 29.5 | 10.9 |
| DF40B-50DS-0.4V(51) | 24 | 11.5 | 25.5 | 29.5 | 12.9 |
| DF40B-60DS-0.4V(51) | 24 | 11.5 | 25.5 | 29.5 | 14.9 |
| DF40B-80DS-0.4V(51) | 32 | 14.2 | 33.5 | 37.5 | 18.9 |
| DF40B-100DS-0.4V(51) | 44 | 20.2 | 45.5 | 49.5 | 22.9 |

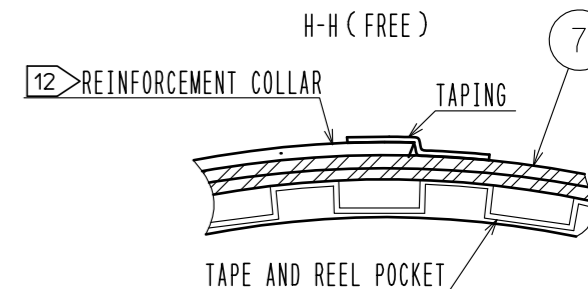

NOTES 7. PER REEL 5000 CONNECTORS.

8. THE DIMENSIONS IN PARENTHESES ARE FOR REFERENCE.
- 9) REFER TO JIS C 0806(IEC 60286-3)(PACKING OF COMPONENTS FOR AUTOMATIC HANDLING)
- 10) DETAIL OF PART No. LABEL IS WRITTEN IN JAPANESE.
PART No. LABEL DESCRIBES THE FOLLOWING INFORMATION FROM TOP.
PRODUCTION DATE:
PRODUCT CODE: CL684-*****-51
PART NUMBER: DF40B-*DS-0.4V(51)
NUMBER OF PIECES: 5000 PIECES
SUPPLIER NAME: HIROSE ELECTRIC CO., LTD.
11. 80 TO 100 POSITIONS EMBOSSED CARRIER TAPE HAS THE SPROCKET HOLE ON BOTH SIDES.
- 12) AFTER PACKAGING, ROLL 2 METERS OF THE REINFORCEMENT COLLAR TO OUTER CIRCUMFERENCE OF TAPE AND REEL POCKET, AND TAPE DOWN AT THE END THE COLLAR.

| | | |
|------------|-------------|--------------------|
| HRS | DRAWING NO. | EDC3-316871-01 |
| | PART NO. | DF40B-*DS-0.4V(51) |
| | CODE NO. | CL684 |

X-ON Electronics

Largest Supplier of Electrical and Electronic Components

Click to view similar products for [Board to Board & Mezzanine Connectors](#) category:

Click to view products by [Hirose](#) manufacturer:

Other Similar products are found below :

[589158040000018](#) [MDF7C-18P-2.54DSA\(55\)](#) [FCN-230C068-11](#) [FCN-268F012-G/BD](#) [FCN-268F036-G/BD](#) [FCN-268M012-G/0D](#) [FCN-268M024-G/1D](#) [FCN-723J004/1](#) [MIS-048-01-F-D-DP-K](#) [832-10-034-10-001000](#) [FX4C-80S-1.27DSA](#) [FCN-214Q030-G/0](#) [FCN-234P048-G/0](#) [FCN-235D050-G/C](#) [210-93-314-41-105000](#) [2-22603-0](#) [MDF7-40DP-2.54DSA\(55\)](#) [AXG720047](#) [MIT-114-03-F-D-K](#) [55323-1519](#) [DF33-2P-3.3DSA\(24\)](#) [YFT-20-05-H-03-SB-K](#) [503308-3040](#) [026-6203-PDB](#) [027-6203-PDB](#) [069159702701000](#) [10123981-102LF](#) [101A10019X](#) [55650-0588-C](#) [68682-310LF](#) [68684-306](#) [75140-7012](#) [87471-650](#) [YTW-30-07-H-Q-410-140](#) [FCN-268F024-G0D](#) [10124054-515LF](#) [68685-603](#) [8-1616154-3](#) [MIS-019-01-F-D](#) [FCN-268M024-G/3D](#) [FCN-268M036-G/BD](#) [20021832-06016C1LF](#) [KX15-20KLDL-E1000E](#) [AXE810124](#) [FCN-214J100-G/0](#) [FCN-230C068-E/S](#) [AXE812124](#) [AXE816124](#) [AXE720127](#) [354184](#)