

Sep.1.2021 Copyright 2021 HIROSE ELECTRIC CO., LTD. All Rights Reserved.
In case of consideration for using Automotive equipment / device which demand high reliability, kindly contact our sales window correspondents.

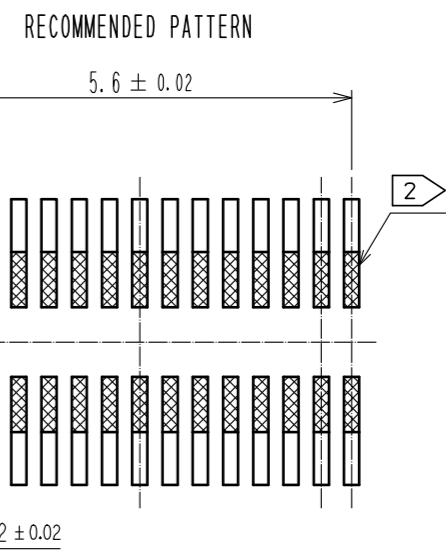

RECOMMENDED METAL MASK THICKNESS : 120 μm
RECOMMENDED METAL MASK OPENING RATIO : 80% FOR LEAD PAD

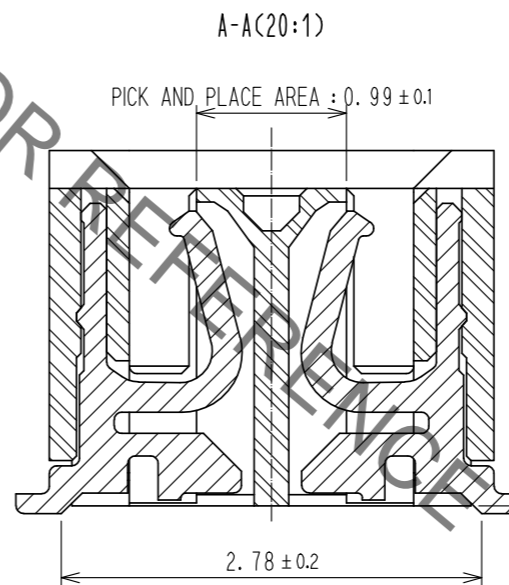
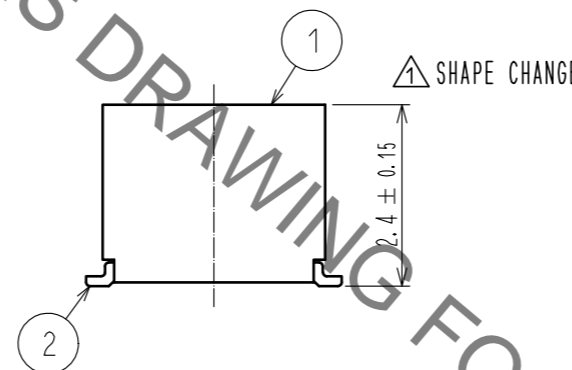
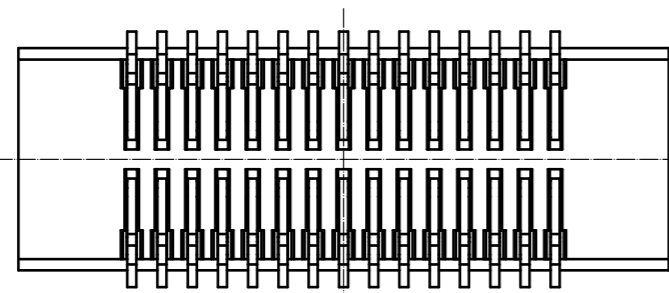
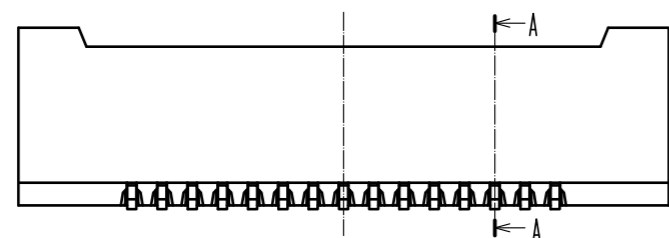
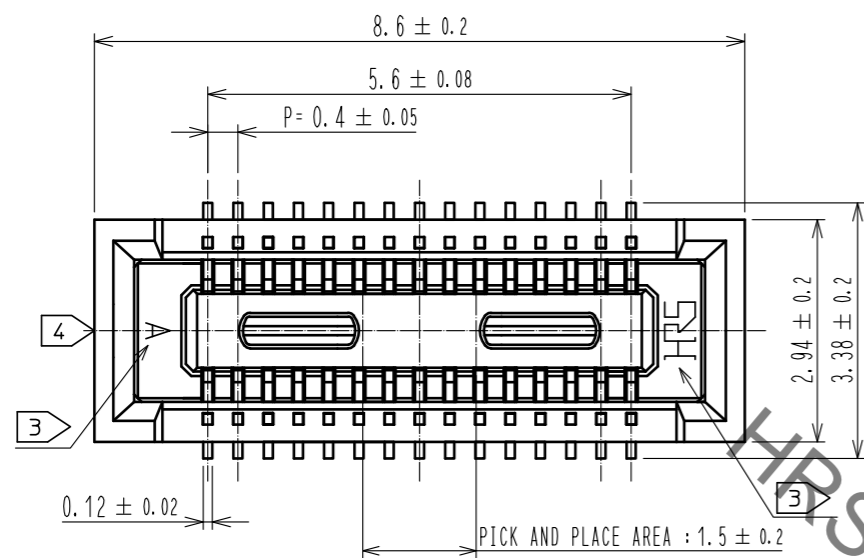
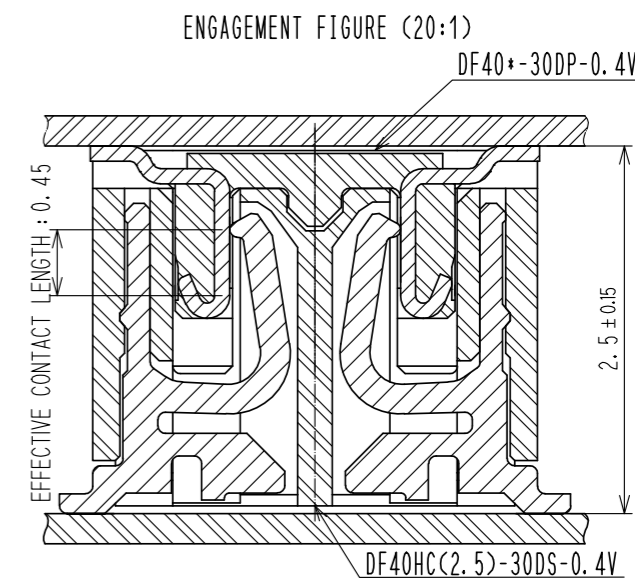

NOTE 1. ALL LEADS CO-PLANARITY SHALL BE 0.1 MAX.
 2 IS NO PATTERN AREA OTHER THAN THE SAME CIRCUIT.
 3 HRS MARK AND CAV NO. IS INDICATED IN APPROXI POSITION SHOWN.
 4 GATE POSITION IS POSITIONED IN APPROXIMAL AREA SHOWN.

2	PHOSPHOR BRONZE	CONTACT AREA: GOLD 0.05 μm MIN	5	PS	BLACK		
		SMT LEAD: GOLD 0.05 μm MIN	4	POLYESTER	CLEAR, COVER TAPE		
		UNDERPLATING: NICKEL 1 μm MIN	3	PS	CLEAR, EMBOSSED CARRIER TAPE		
1	LCP	BLACK, UL94V-0					
NO.	MATERIAL	FINISH . REMARKS	NO.	MATERIAL	FINISH . REMARKS		
UNITS mm		SCALE 10 : 1	COUNT 1	DESCRIPTION OF REVISIONS DIS-H-00007018	DESIGNED RH. KAGAMI	CHECKED YK. SATAKE	DATE 20201211
HRS HIROSE ELECTRIC CO., LTD.		APPROVED : KH. IKEDA 20081215	DRAWING NO. EDC3-319957-01				
		CHECKED : TS. MIYAZAKI 20081215	PART NO. DF40HC(2.5)-30DS-0.4V(70)				
		DESIGNED : TK. SUZUKI 20081215	CODE NO. CL0684-4127-6-70				
		DRAWN : TK. SUZUKI 20081215					

Sep.1.2021 Copyright 2021 HIROSE ELECTRIC CO., LTD. All Rights Reserved.
In case of consideration for using Automotive equipment / device which demand high reliability, kindly contact our sales window correspondents.

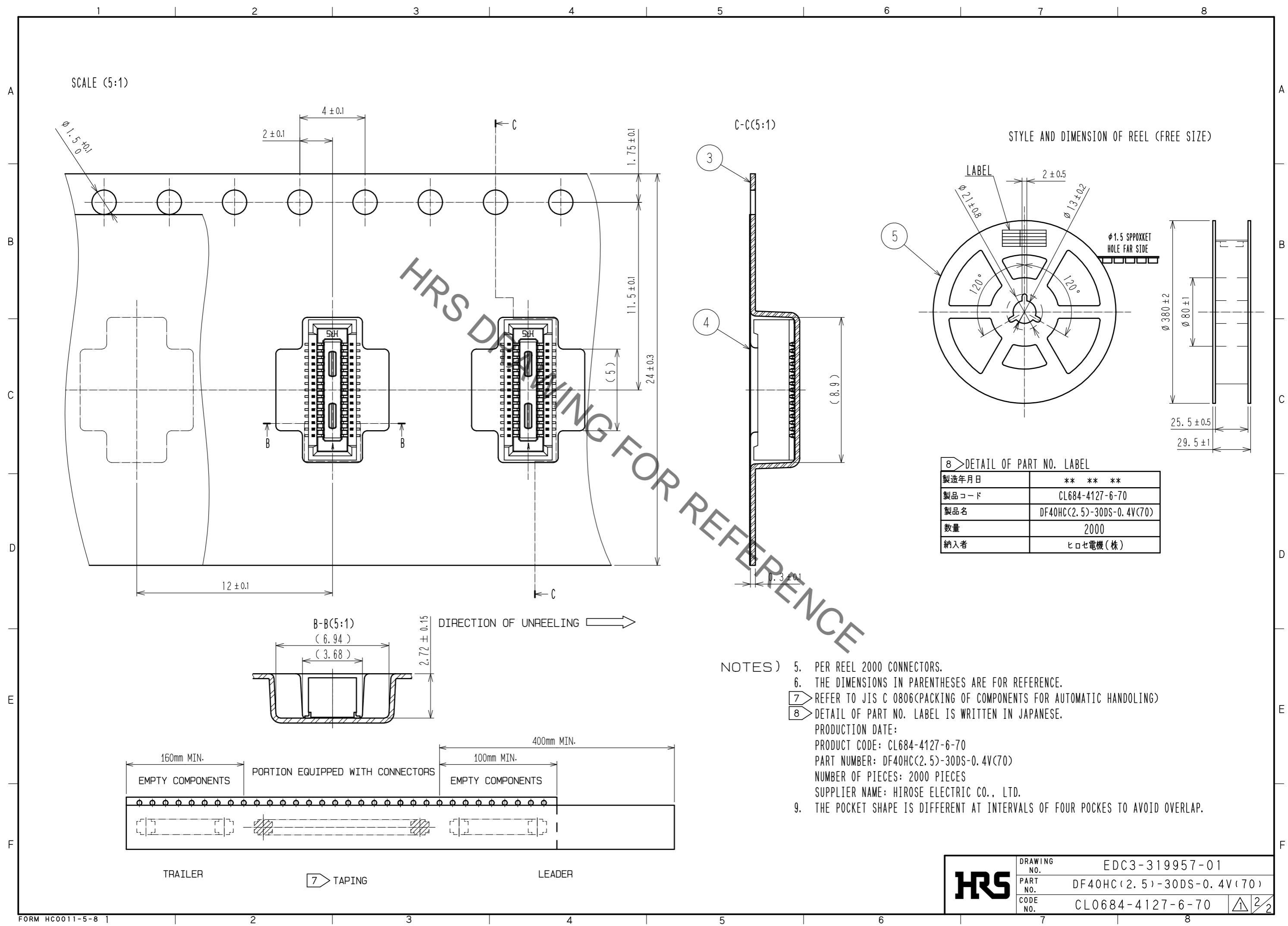

8 > DETAIL OF PART NO. LABEL	
製造年月日	** ** *
製品コード	CL684-4127-6-70
製品名	DF40HC(2.5)-30DS-0.4V(70)
数量	2000
納入者	ヒロセ電機(株)

- NOTES)
- PER REEL 2000 CONNECTORS.
 - THE DIMENSIONS IN PARENTHESES ARE FOR REFERENCE.
 - REFER TO JIS C 0806(PACKING OF COMPONENTS FOR AUTOMATIC HANDLING)
 - DETAIL OF PART NO. LABEL IS WRITTEN IN JAPANESE.
PRODUCTION DATE:
PRODUCT CODE: CL684-4127-6-70
PART NUMBER: DF40HC(2.5)-30DS-0.4V(70)
NUMBER OF PIECES: 2000 PIECES
SUPPLIER NAME: HIROSE ELECTRIC CO., LTD.
 - THE POCKET SHAPE IS DIFFERENT AT INTERVALS OF FOUR POKCES TO AVOID OVERLAP.

HRS	DRAWING NO.	EDC3-319957-01
	PART NO.	DF40HC(2.5)-30DS-0.4V(70)
	CODE NO.	CL0684-4127-6-70
		2/2

X-ON Electronics

Largest Supplier of Electrical and Electronic Components

Click to view similar products for [Board to Board & Mezzanine Connectors](#) category:

Click to view products by [Hirose](#) manufacturer:

Other Similar products are found below :

[589158040000018](#) [MDF7C-18P-2.54DSA\(55\)](#) [FCN-230C068-11](#) [FCN-268F012-G/BD](#) [FCN-268F036-G/BD](#) [FCN-268M012-G/0D](#) [FCN-268M024-G/1D](#) [FCN-723J004/1](#) [MIS-048-01-F-D-DP-K](#) [832-10-034-10-001000](#) [FX4C-80S-1.27DSA](#) [FCN-214Q030-G/0](#) [FCN-234P048-G/0](#) [FCN-235D050-G/C](#) [210-93-314-41-105000](#) [2-22603-0](#) [MDF7-40DP-2.54DSA\(55\)](#) [AXG720047](#) [MIT-114-03-F-D-K](#) [55323-1519](#) [DF33-2P-3.3DSA\(24\)](#) [YFT-20-05-H-03-SB-K](#) [503308-3040](#) [026-6203-PDB](#) [027-6203-PDB](#) [069159702701000](#) [10123981-102LF](#) [101A10019X](#) [55650-0588-C](#) [68682-310LF](#) [68684-306](#) [75140-7012](#) [87471-650](#) [YTW-30-07-H-Q-410-140](#) [FCN-268F024-G0D](#) [10124054-515LF](#) [68685-603](#) [8-1616154-3](#) [MIS-019-01-F-D](#) [FCN-268M024-G/3D](#) [FCN-268M036-G/BD](#) [20021832-06016C1LF](#) [KX15-20KLDL-E1000E](#) [AXE810124](#) [FCN-214J100-G/0](#) [FCN-230C068-E/S](#) [AXE812124](#) [AXE816124](#) [AXE720127](#) [354184](#)