

Sep.1.2021 Copyright 2021 HIROSE ELECTRIC CO., LTD. All Rights Reserved.
In case of consideration for using Automotive equipment / device which demand high reliability, kindly contact our sales window correspondents.

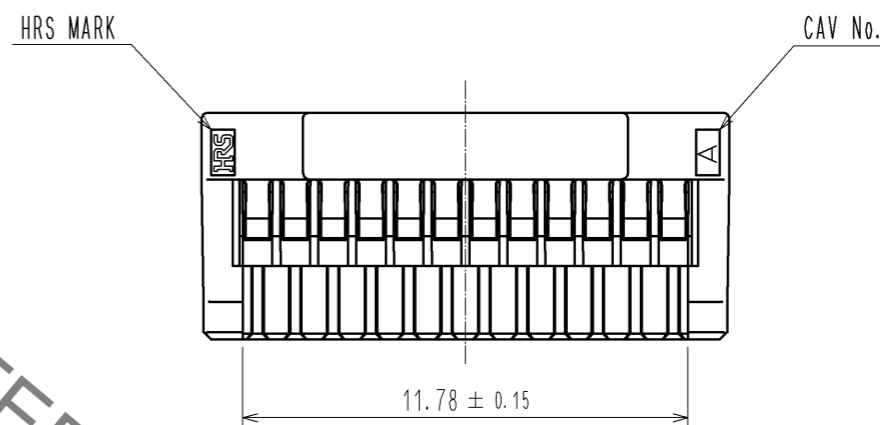
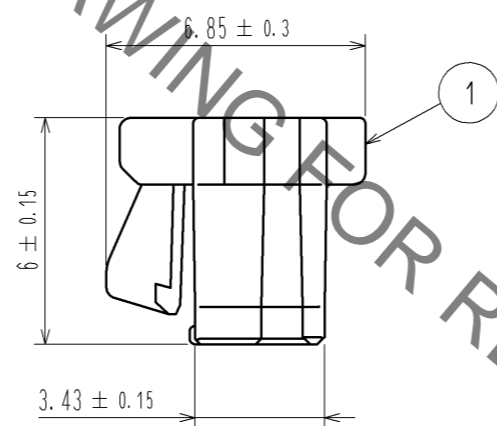
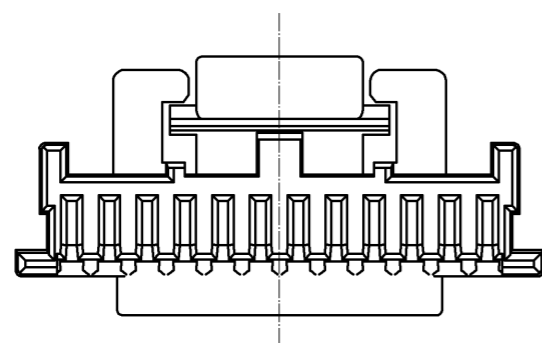
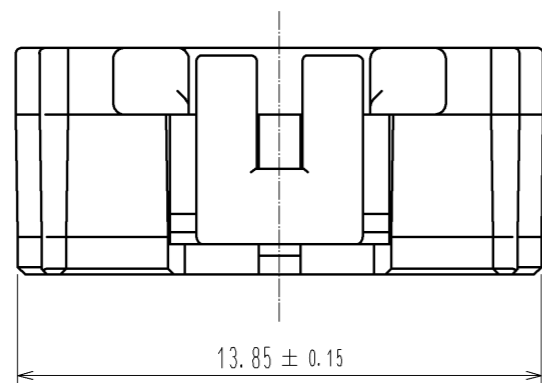
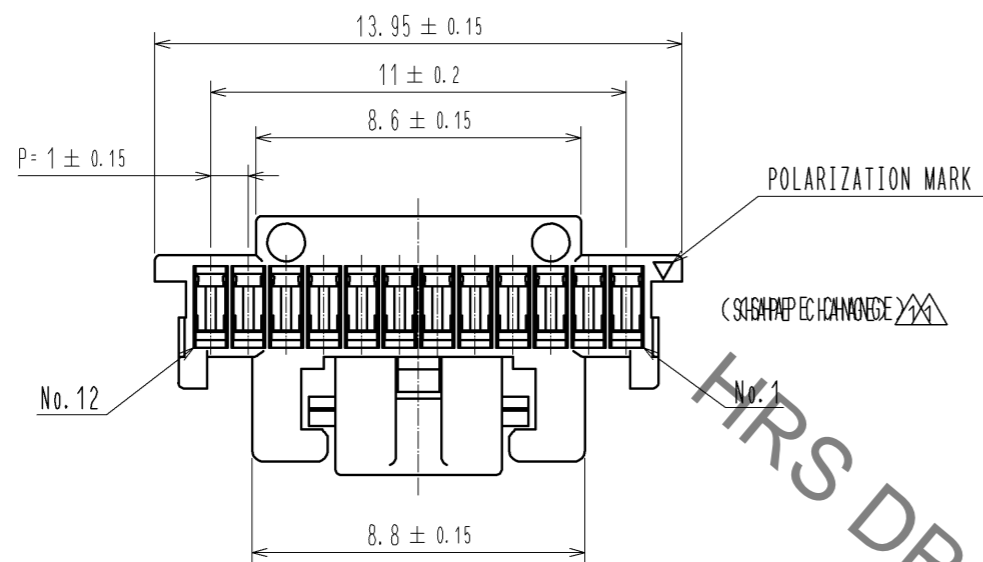

HRS DRAWING FOR REFERENCE

NOTE1. PER PACK:100 PIECES

NO.		MATERIAL		FINISH . REMARKS		1	PBT	UL94V-0. BLACK	
UNITS mm		SCALE 5 : 1		COUNT 1	DESCRIPTION OF REVISIONS DIS-H-005903		DESIGNED KT. ISHII	CHECKED OM. MIYAMOTO	DATE 11.06.16
HIROSE ELECTRIC CO., LTD.		APPROVED : KI. AKIYAMA		10.12.14		DRAWING NO. EDC3-329676-00			
		CHECKED : OM. MIYAMOTO		10.12.14		PART NO. DF50A-12S-1C			
		DESIGNED : TT. OHSAKO		10.12.14		CODE NO. CL665-1022-3-00			
		DRAWN : TT. OHSAKO		10.12.14					

X-ON Electronics

Largest Supplier of Electrical and Electronic Components

Click to view similar products for [Headers & Wire Housings](#) category:

Click to view products by [Hirose](#) manufacturer:

Other Similar products are found below :

[892-18-020-10-001101](#) [58102-G61-06LF](#) [582553-1](#) [0009485154](#) [009176003701906](#) [0050291907](#) [LY20-4P-DT1-P1E-BR](#) [02.125.8002.8](#)
[609-3404](#) [61062-3](#) [622-0430](#) [622-3653LF](#) [63453-116](#) [636-1030](#) [636-1427](#) [636-3427](#) [636-4007](#) [641938-9](#) [641991-4](#) [644827-2](#) [65817-010LF](#)
[65817-015LF](#) [65863-015LF](#) [66207-023LF](#) [67095-007LF](#) [67601157](#) [68648-049](#) [70.362.1628.0](#) [70-4210](#) [70-4226B](#) [70-4853B](#) [707-5020](#) [707-](#)
[5028](#) [71.350.2428.0](#) [71918-208LF](#) [71961-016LF](#) [733-134](#) [733-162](#) [754199-000](#) [760-3052](#) [787-8014-00](#) [79531-3000](#) [FCN-360C032-B](#) [FCN-](#)
[367T-T012/H](#) [FCN-723D010/2](#) [80.063.4001.1](#) [800-90-001-10-001000](#) [800-90-010-10-002000](#) [801-43-002-10-013000](#) [801-43-006-10-002000](#)