

4.5 mm pitch, Horizontal Mating 2-Piece System Connectors

DF64 Series

(UL pending)



■ Features

1. Versatile Board-to-Board and Board-to-Wire System

The DF64 Series connector system is a Board-to-Board connector and Board-to-Wire that utilizes a unique floating structure and a Board-to-Wire connector that features an excellent locking system

2. Floating structure

The Board-to-Board floating structure delivers an increased connection range together with a wide effective mating length and width. The unique stress-free contact structure was designed to absorb movement and misalignment between serial PCBs and ensure a continuous connection. (Please refer to Figure 1)

Movement tolerance range for the X axis: ± 0.5 mm

Movement tolerance range for the Y axis: MAX 2 mm

3. Reliable contact design (B-to-B connection)

Our two-point contact structure provides a highly reliable contact system. (Please refer to Figure 2)

4. Stress free side-locking system for Board-to-Wire connections

The BTW side-locking structure provides a clear tactile click to confirm completion of the mating process and also allows for a visual check on the side locks. The structure endures wiring stress and prevents the wires from being pulled out of alignment. (Please refer to Figure 3)

5. 350V voltage capacity

Its unique mating structure secures a creepage distance of no less than 3.2 mm between the contacts and produces a 350 V voltage capacity.

6. PCB layout simplification

The DF64 connector system shares one common receptacle. This helps to simplify the PCB layout by accepting the BTB header and the BTW cable plug.

7. Resistant to high heat

These connectors can operate in temperatures of up to 105°C

◆ The floating structure of the BTB connection provides increased flexibility by absorbing the movement of the PCB's.

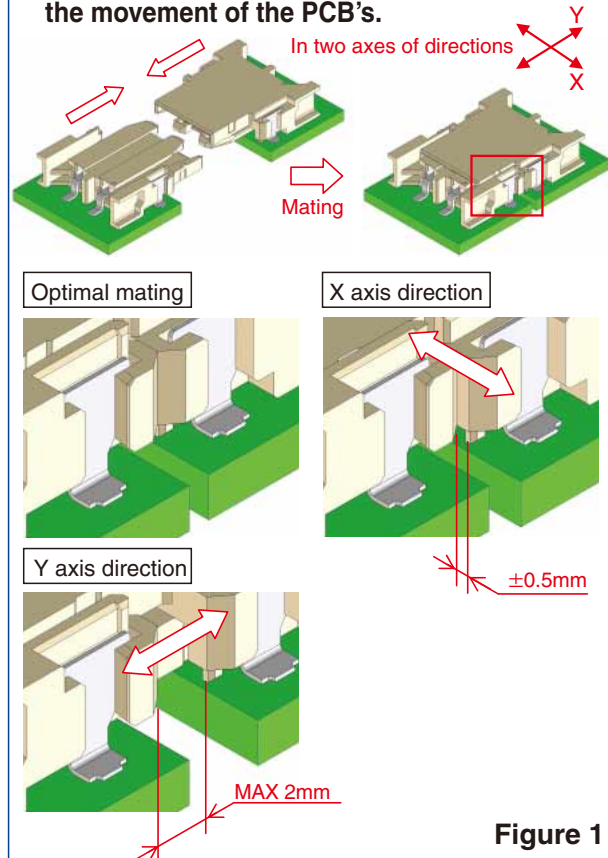

Figure 1

◆ Two-point contact structure

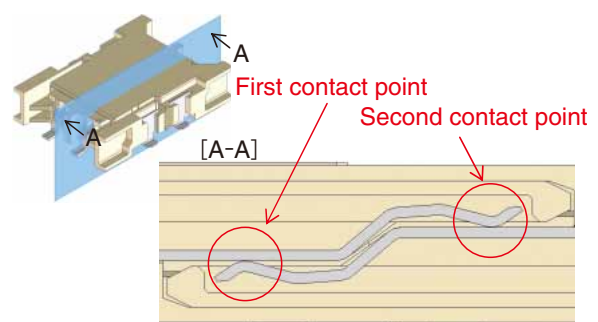

Figure 2

◆ BTW side-lock structure

Clear tactile click and visual check possible.

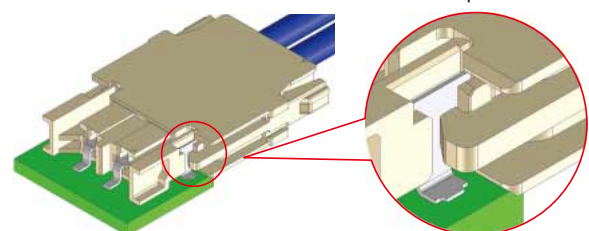

Figure 3

Product Specifications

Ratings	Current Rating (Note 1)	BtoB	BtoW			Operating Temperature Range: -55 ~ to 105°C (Note 2) Operating Humidity Range : 20 to 80% (Note 3)
	Voltage Rating	5A	AWG#18 5A	AWG#20 4A	AWG#22 3A	
			AC/DC 350V			Storage Temperature Range: -10 to 60°C (Note 4) Storage Humidity Range : 40 - 70% (Note 4)

Item	Specifications	Conditions
1. Insulation resistance	No less than 1,000 MΩ	Measured at DC 500 V
2. Withstand voltage	No flashover or breakdown	AC 1, 500 V is applied for one minute.
3. Contact resistance	30 MΩ max	Measured at no more than DC 6 V, 100 mA (DC or 1,000 Hz)
4. Vibration Resistance	No electrical discontinuity of 1μs or greater	Frequency 10-55 Hz, half amplitude 0.75 mm, 10 cycles in each of three directions(axes)
5. Shock Resistance	No electrical discontinuity outage of 1μs or greater	Accelerated velocity: 490 m/s ² , for 11 ms, half-sine in 3 directions, 3 times for each of the three directions (axes)
6. Moisture-resistance	■ Contact resistance 30 MΩ max ■ Insulation resistance 1,000 MΩ minimum	Temperature: 40 ±2°C; humidity: 90 to 95%, left as it is for 96 hours
7. Temperature cycles	■ Contact resistance 30 MΩ max ■ Insulation resistance 1,000 MΩ minimum	-55°C for 30 minutes → 5 to 35°C for 2 to 3 minutes → 105°C for 30 minutes → 5 to 35°C for 2 to 3 minutes) in 5 cycles
8. Durability	■ Contact resistance 30 MΩ max	■ Number of matings/unmatings 10 mating cycles
9. Resistance to solder heat	The resin components will not become deformed or loose performance due to deformities	Reflow: according to the Recommended Temperature Profile Hand soldering: temperature of soldering iron at 350°C±10°C for 3 seconds

(Note 1) This is the maximum current rating while all pins are powered or used as all power lines.

(Note 2) Includes the temperature rise of power lines.

(Note 3) Use without condensation on parts.

(Note 4) The storage condition refers to long-term storage of the product on the shelf before assembly. Please use the operating temperature for temporary storage such as pre-assembly and during shipping.

Materials

Product	Part	Materials	Finish	UL spec.
Receptacle	Insulator	LCP	Beige	UL94V-0
	Contact	Copper alloy	Tin-plating	-
	Reinforcing metal fittings	Brass	Tin-plating	-
Header	Insulator	LCP	Beige	UL94V-0
	Contact	Copper alloy	Tin-plating	-
	Reinforcing metal fittings	Brass	Tin-plating	-
Crimp case	Insulator	LCP	Beige	UL94V-0
Crimp contact	Contact	Phosphorous Bronze	Tin-plating	-

Product Number Structure

Refer to the charts below for determining specific part number characteristics.

Please select connectors listed in this catalog when placing orders and be sure to check the latest delivery specifications at the time of ordering the product.

Connector

DF 64 - * S - 4.5 H
 ① ② ③ ④ ⑤ ⑥

DF 64 - * P - 4.5 H
 ① ② ③ ④ ⑤ ⑥

DF 64 - * P - 4.5 C
 ① ② ③ ④ ⑤ ⑥

① Series Name: DF	⑤ Pitch : 4.5 mm
② Series No.: 64	⑥ Wiring type H: SMT Right Angle Type C: crimp housing
③ Number of contacts: 2, 3	
④ Connector type S: receptacle P: plug	

Contact

DF 64 - 1822 PCF
 ① ②

① Applicable wire size 1822 : 18 – 22 AWG	② Packaging style PCF: In-line plug plug contact, on reel PC: In-line plug contact, loose piece
--	---

Right angle receptacle

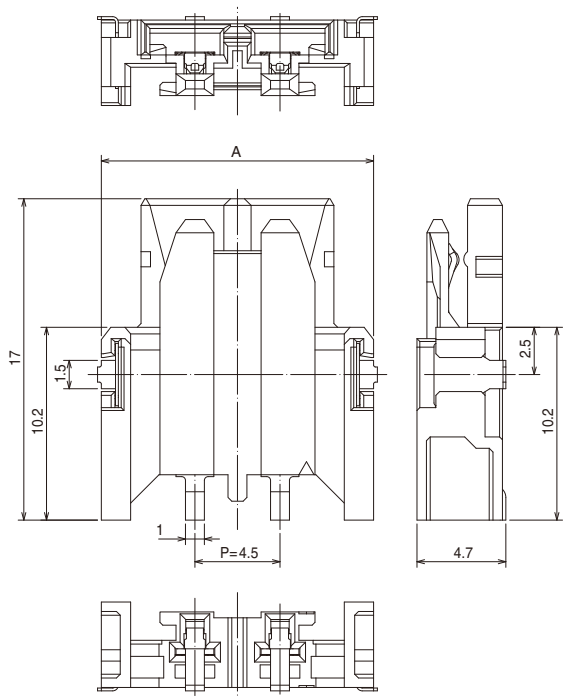

Recommended PCB layout (t=1.6 mm)

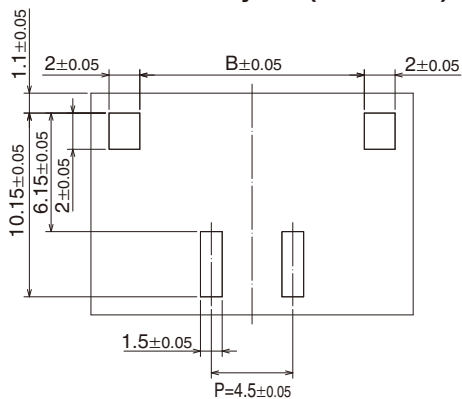

Part Number.	HRS No.	No. of Contacts	A	B
DF64-2S-4.5H	667-1002-9-00	2	14.4	11.8
DF64-3S-4.5H	Under development	3	18.9	16.3

(Note) This product is sold 500 connectors per reel. Please order by full reel quantities.

Tape and Reel dimensions

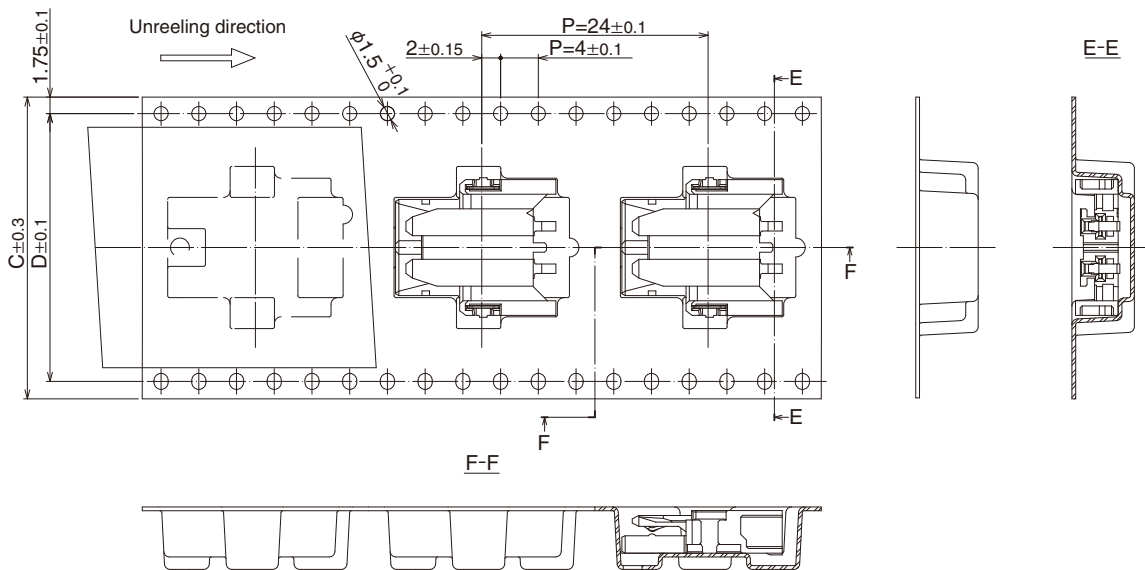

Part Number	HRS No.	No. of Contacts	C	D
DF64-2S-4.5H	667-1002-9-00	2	32	28.4
DF64-3S-4.5H	Under development	3	44	40.4

Feb.1.2016 Copyright 2016 HIROSE ELECTRIC CO., LTD. All Rights Reserved.

Right angle pin header (SMT)

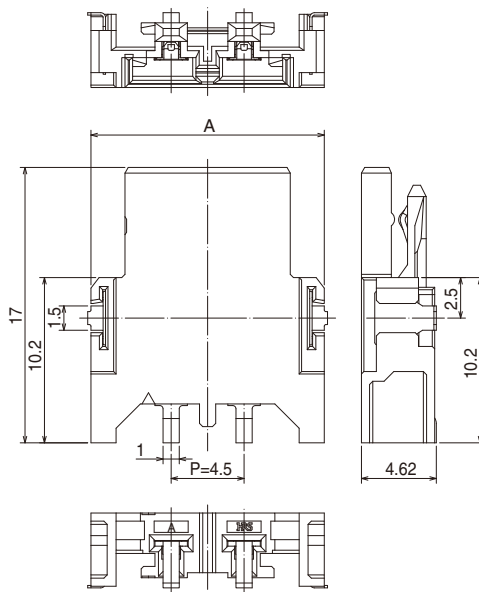
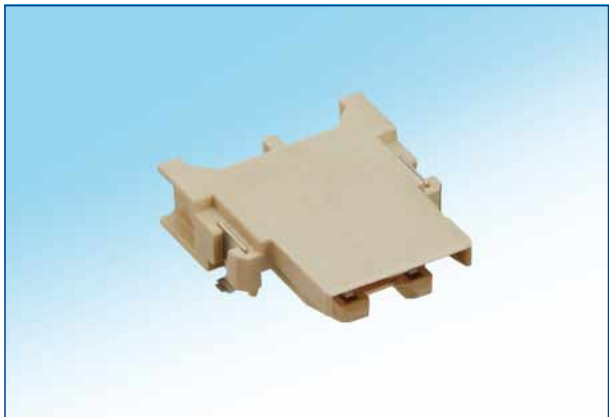

Recommended PCB layout (t=1.6 mm)

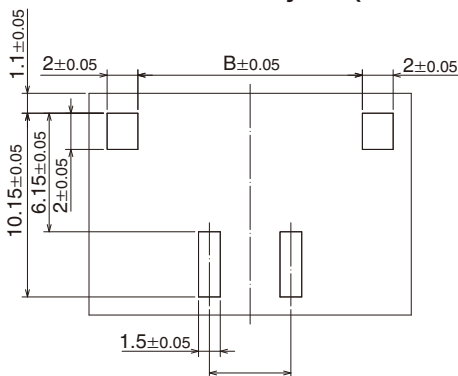

Product No.	HRS No.	No. of Contacts	A	B
DF64-2P-4.5H	667-1001-6-00	2	14.4	11.8
DF64-3P-4.5H	Under development	3	18.9	16.3

(Note) This product is sold 500 connectors per reel. Please order by full reel quantities.

Tape and Reel dimensions

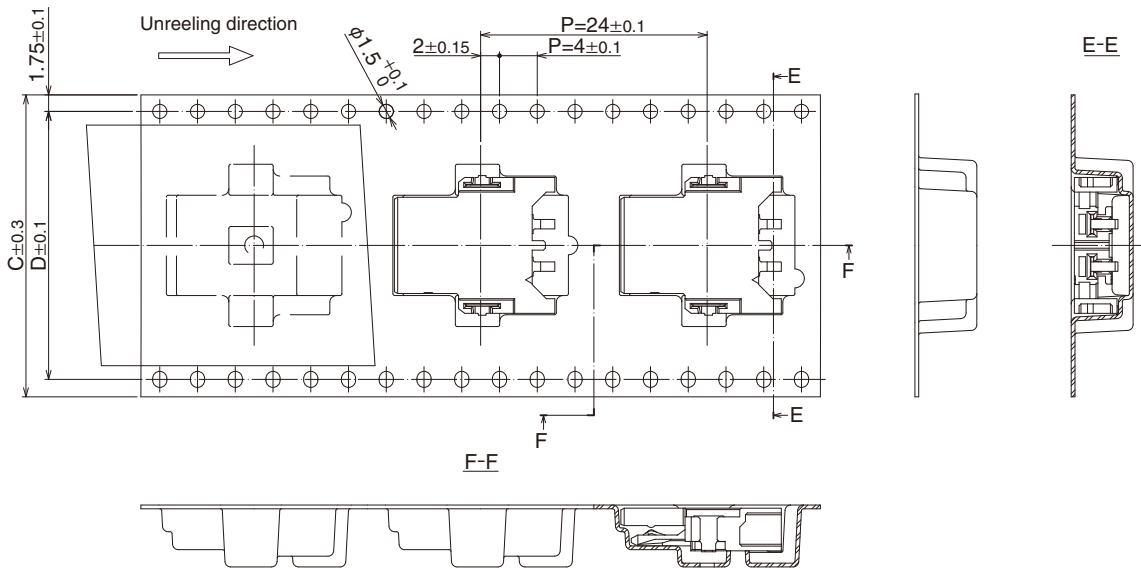

Product No.	HRS No.	No. of Contacts	C	D
DF64-2P-4.5H	667-1001-6-00	2	32	28.4
DF64-3P-4.5H	Under development	3	44	40.4

■ Crimp socket

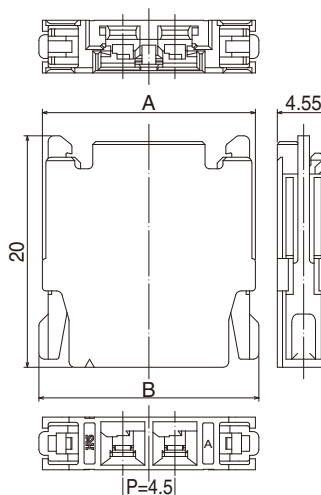

Part Number	HRS No.	No. of Contacts	A	B
DF64-2P-4.5C	667-1003-1-00	2	18.4	19.0
DF64-3P-4.5C	Under development	3	22.9	23.5

(Note) Each package contains 100 pieces. Please order in full package quantities.

[Specification Number]
None: 1 package contains 100 pieces

■ Crimp contact

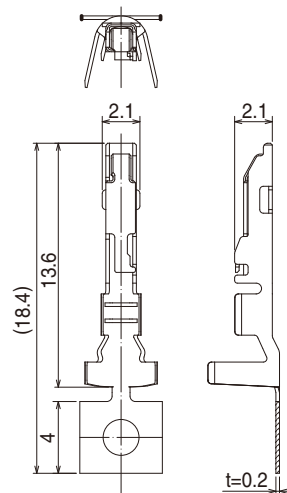
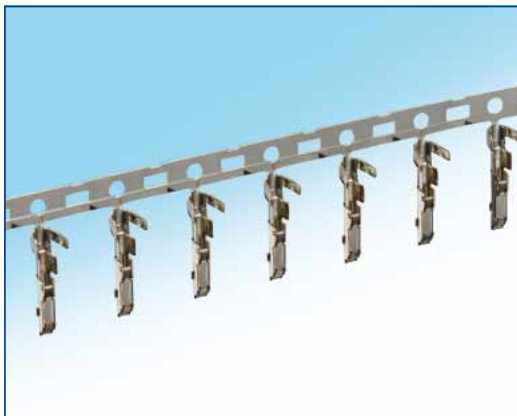

Product No.	HRS No.	Type	Quantity	Finish
DF64-1822PCF	667-1004-4-00	Reel contact (Note 1)	1 reel = 5,000 pieces	Tin-plating
DF64-1822PC	Under development	Loose piece contact (Note 2)	1 package = 100 pieces	

(Note 1) This product is sold 5,000 pieces per reel. Please order by full reel quantities.

(Note 2) Each package contains 100 pieces. Please order in full package quantities.

● Applicable wire (Tinned, annealed copper wire)

Conductor size (Core structure)	Jacket Diameter
AWG (34 pieces/φ 0.18 mm)	UL1015 (φ2.9mm)
AWG (21 pieces/φ 0.18 mm)	UL1015 (φ2.6mm)
AWG (17 pieces/φ 0.16 mm)	UL1015 (φ2.4mm)

● Recommended wire

UL1015

● Strip length

3.0~4.0mm

(Note 1) Applicable wires will have conductors that are comprised of annealed, tin-plated material.

(Note 2) Please contact your local Hirose sales rep if you plan on using wires other than those listed above.

◆ Applicable crimping tool

Item	Part Number	HRS No.	Applicable contact
Applicator	AP105-DF64-1822	CL901-4633-9-00	DF64-1822PCF
Press body	CM-105	CL901-0005-4-00	-
Hand tool	HT801/DF64-1822	Under development	DF64-1822PC
Extraction tool	DF62/RE-MD	CL902-4645-4-00	DF64-1822PCF DF64-1822PC

(Note 1) Please conduct crimping work according to the "Crimping work standards" and "Crimping condition table".

(Note 2) Hirose does not cover damage created by the use of unapproved Hirose Tools. Please contact your local Hirose Sales for clarification.

(Note 3) Hand tools do not have replaceable dies.

(Note 4) Approved wire is limited to UL1015; 18, 20, 22 AWG.

◆ Precautionary notes

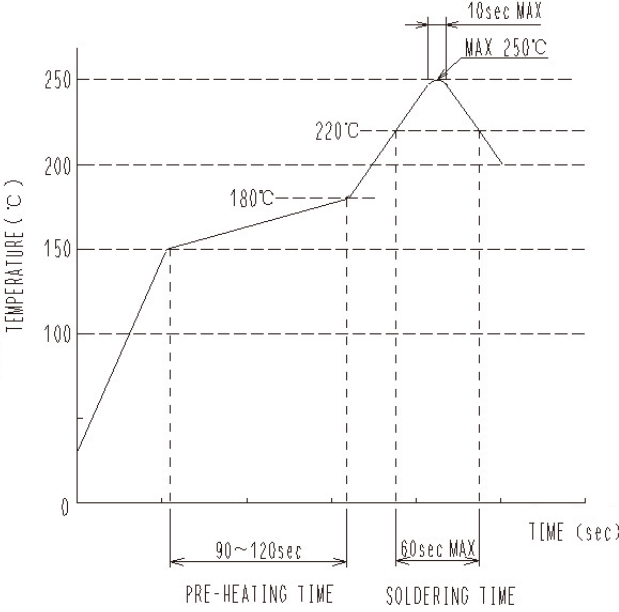
<p>1. Recommended Temperature Profile (Compatible with lead-free soldering)</p>	 <p>[Applicable Conditions]</p> <ol style="list-style-type: none"> 1. Peak temperature 2. Heating unit: no less than 220°C for no more than 60 seconds 3. Preheating unit: 150 to 180°C for 90 to 120 seconds 4. Number of times: 2 times max. <p>* Measurement is conducted at the contact lead part Please check the mounting conditions before use. Conditions such as solder paste types, manufacturer, PCB size and any other soldering materials may alter the performance of such materials.</p> <p>(Note 1) This temperature profile is a recommended value only; please contact your Hirose Sales Rep for more information</p>
<p>2. Recommended hand soldering conditions</p>	<p>Temperature of soldering iron: 350±10°C, soldering time: no more than 3 seconds</p>
<p>3. Recommended screen thickness, aperture ratio (pattern surface ratio)</p>	<p>Thickness: 0.1 mm, aperture ratio: 100%</p>
<p>4. Warping of the Board</p>	<p>A maximum of 0.02 mm at the center of connector, as measured from either end of the connector</p>
<p>5. Cleaning Conditions</p>	<p>IPA cleaning is allowed. (Cleaning is not recommended because cleaning may change the push/pull feeling etc. Please contact your local Hirose representative prior to the use of any cleaning agents.)</p>
<p>6. Important Notes</p>	<ul style="list-style-type: none"> ■ When inserting the crimp contact into the crimp socket, do not insert it at a slanted angle to maintain the reliability of its performance. ■ Please use caution when mating/unmating this connector if it has not been mounted onto the PCB, doing so could deform or damage the contacts. ■ Do not pull on the wires of this connector as this may cause damage to the connector. ■ During the hand soldering process, make sure to not apply too much flux. Doing so may cause a solder wicking problem. ■ This product may experience some differences in color from one production lot to another. This color difference does not influence the performance of the connector.



HIROSE ELECTRIC CO.,LTD.

6-3,Nakagawa Chuoh-2-Chome,Tsuzuki-Ku,Yokohama-Shi 224-8540,JAPAN
 TEL: +81-45-620-3526 Fax: +81-45-591-3726
<http://www.hirose.com>
<http://www.hirose-connectors.com>

X-ON Electronics

Largest Supplier of Electrical and Electronic Components

Click to view similar products for [Lighting Connectors](#) category:

Click to view products by [Hirose](#) manufacturer:

Other Similar products are found below :

[293300-7](#) [293660-5](#) [CNX_H03_NTP](#) [30-9767-BU](#) [3605](#) [3-21030-1](#) [ZCH-110-RGB-I](#) [503471-0290](#) [ZCH-110-RGB-J](#) [217-0716-200](#)
[1954563-1](#) [1-293657-2](#) [2834036-1](#) [2834037-1](#) [1-2213222-4](#) [2-2213222-4](#) [2213222-4](#) [2834122-3](#) [2834122-5](#) [2834135-2](#) [FLA-R4142-30](#)
[FLA-R4162-30](#) [FLA-R2142-30](#) [FLA-R2162-30](#) [FLA-R2161-30](#) [FLA-R0161-30](#) [FLA-R0141-30](#) [FLA-R0142-30](#) [FLA-R0162-30](#) [FLA-C00-](#)
[00](#) [DGA00010553](#) [CNXV04NTP](#) [104128-0610](#) [503485-0000 \(Cut Strip\)](#) [503485-0000 \(Loose Piece\)](#) [503485-0000 \(MINI Reel\)](#) [1-2834074-2](#)
[1-2834074-3](#) [1357-AC PLUG W2C \(CHINA\)](#) [1357-AC PLUG W2 \(USA\)](#) [104266-0110](#) [CNXV02NTP](#) [2106212-1](#) [2-2834074-2](#) [104266-](#)
[0210](#) [293470-1](#) [293651-2](#) [293651-4](#) [1-2834006-2](#) [293651-1](#)